



**HESTORE.HU**

elektronikai alkatrész áruház

**EN:** This Datasheet is presented by the manufacturer.

Please visit our website for pricing and availability at [www.hestore.hu](http://www.hestore.hu).

**SOLID-STATE HEXADECIMAL DISPLAY WITH  
INTEGRAL TTL CIRCUIT TO ACCEPT, STORE,  
AND DISPLAY 4-BIT BINARY DATA**

- 0.300-Inch (7,62-mm) Character Height
- High Brightness
- Left-and-Right-Hand Decimals
- Separate LED and Logic Power Supplies May Be Used
- Wide Viewing Angle
- Internal TTL MSI Chip With Latch, Decoder, and Driver
- Operates from 5-V Supply
- Constant-Current Drive for Hexadecimal Characters
- Easy System Interface

**mechanical data**

These assemblies consist of display chips and a TTL MSI chip mounted on a header with a red molded plastic body. Multiple displays may be mounted on 0.450-inch (11,43-mm) centers.

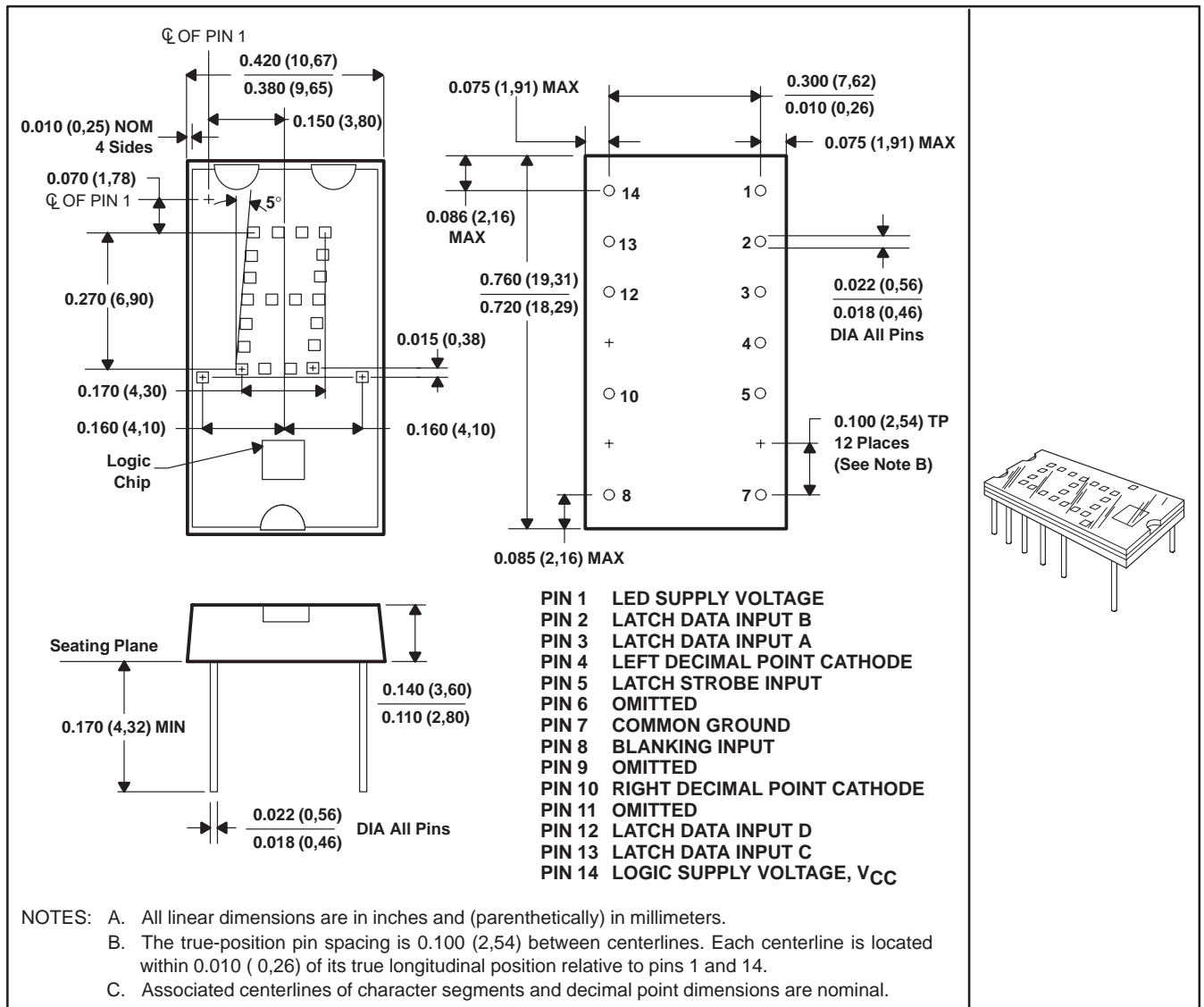

# TIL311 HEXADECIMAL DISPLAY WITH LOGIC

SODS001D – MARCH 1972 – REVISED DECEMBER 1997

## description

This hexadecimal display contains a four-bit latch, decoder, driver, and 4 × 7 light-emitting-diode (LED) character with two externally driven decimal points in a 14-pin package. A description of the input functions of this device follows.

FUNCTION	PIN NO.	DESCRIPTION
LATCH STROBE INPUT	5	When low, the data in the latches follow the data on the latch data inputs. When high, the data in the latches will not change. If the display is blanked and then restored while the enable input is high, the previous character will again be displayed.
BLANKING INPUT	8	When high, the display is blanked regardless of the levels of the other inputs. When low, a character is displayed as determined by the data in the latches. The blanking input may be pulsed for intensity modulation.
LATCH DATA INPUTS (A, B, C, D)	3, 2, 13, 12	Data on these inputs are entered into the latches when the enable input is low. The binary weights of these inputs are A = 1, B = 2, C = 4, D = 8.
DECIMAL POINT CATHODES	4, 10	These LEDs are not connected to the logic chip. If a decimal point is used, an external resistor or other current-limiting mechanism must be connected in series with it.
LED SUPPLY	1	This connection permits the user to save on regulated V <sub>CC</sub> current by using a separate LED supply, or it may be externally connected to the logic supply (V <sub>CC</sub> ).
LOGIC SUPPLY VOLTAGE (V <sub>CC</sub> )	14	Separate V <sub>CC</sub> connection for the logic chip
COMMON GROUND	7	This is the negative terminal for all logic and LED currents except for the decimal points.

The LED driver outputs are designed to maintain a relatively constant on-level current of approximately 5 mA through each LED that forms the hexadecimal character. This current is virtually independent of the LED supply voltage within the recommended operating conditions. Drive current varies slightly with changes in logic supply voltage resulting in a change in luminous intensity as shown in Figure 2. This change will not be noticeable to the eye. The decimal point anodes are connected to the LED supply; the cathodes are connected to external pins. Since there is no current limiting built into the decimal point circuits, limiting must be provided externally if the decimal points are used.

The resultant displays for the values of the binary data in the latches are as shown below.

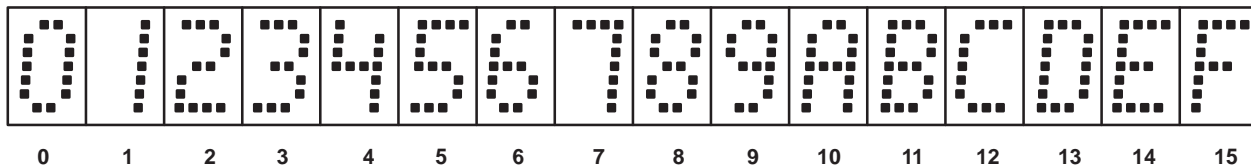

functional block diagram

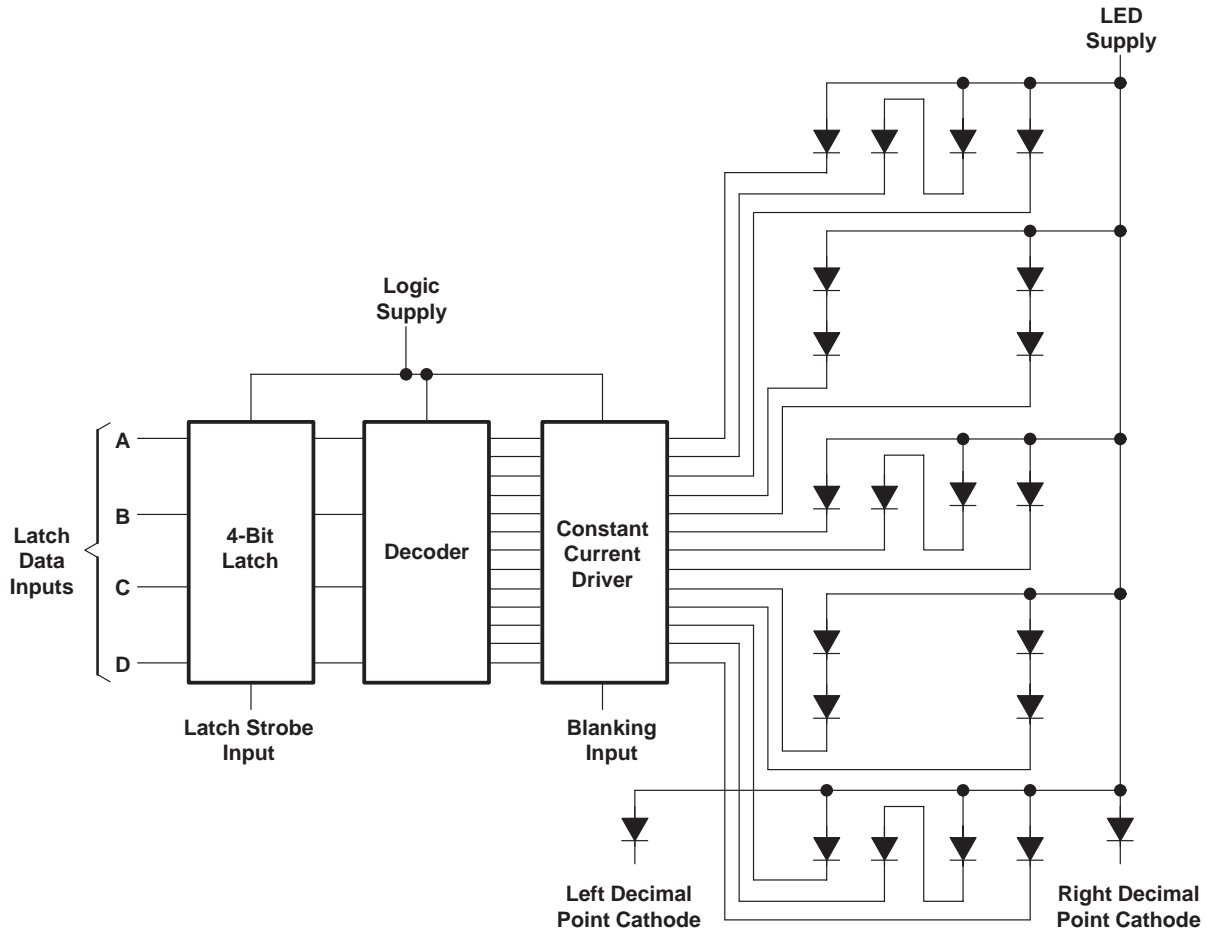

absolute maximum ratings over operating case temperature range (unless otherwise noted)

Supply voltage, $V_{CC}$ , logic (see Note 1)	7 V
Supply voltage, LED (see Note 1)	7 V
Input voltage (pins 2, 3, 5, 8, 12, 13) (see Note 1)	5.5 V
Decimal point current	20 mA
Operating case temperature range (see Note 2)	0°C to 85°C
Storage temperature range	-25°C to 85°C

- NOTES: 1. Voltage values are with respect to common ground terminal.  
 2. Case temperature is the surface temperature of the plastic measured directly over the integrated circuit. Forced-air cooling may be required to maintain this temperature.

recommended operating conditions

	MIN	NOM	MAX	UNIT
Supply voltage, $V_{CC}$ , logic	4.5	5	5.5	V
Supply voltage, $V_{LED}$ , LED	4	5	5.5	V
Decimal point current, $I_F(DP)$		5		mA
Pulse duration, $t_w$ , latch strobe	40			ns
Setup time, $t_{SU}$	50			ns
Hold time, $t_H$	40			ns



# TIL311 HEXADECIMAL DISPLAY WITH LOGIC

SODS001D – MARCH 1972 – REVISED DECEMBER 1997

## operating characteristics at $T_A = 25^\circ\text{C}$

PARAMETER		TEST CONDITIONS	MIN	TYP	MAX	UNIT
$I_V$	Luminous intensity (see Note 3)	Average per character LED $V_{CC} = 5\text{ V}, V_{LED} = 5\text{ V},$ See Note 4	35	100		$\mu\text{cd}$
		Each decimal $I_F(\text{DP}) = 5\text{ mA}$	35	100		$\mu\text{cd}$
$\lambda_p$	Wavelength at peak emission	$V_{CC} = 5\text{ V}, V_{LED} = 5\text{ V},$ $I_F(\text{DP}) = 5\text{ mA},$ See Note 5		660		nm
$\Delta\lambda$	Spectral bandwidth			20		nm
$V_{IH}$	High-level input voltage		2			V
$V_{IL}$	Low-level input voltage				0.8	V
$V_{IK}$	Input clamp voltage	$V_{CC} = 4.75\text{ V}, I_I = -12\text{ mA}$			-1.5	V
$I_I$	Input current	$V_{CC} = 5.5\text{ V}, V_I = 5.5\text{ V}$			1	mA
$I_{IH}$	High-level input current	$V_{CC} = 5.5\text{ V}, V_I = 2.4\text{ V}$			40	$\mu\text{A}$
$I_{IL}$	Low-level input current	$V_{CC} = 5.5\text{ V}, V_I = 0.4\text{ V}$			-1.6	mA
$I_{CC}$	Supply current, logic	$V_{CC} = 5.5\text{ V}, V_{LED} = 5.5\text{ V},$ $I_F(\text{DP}) = 5\text{ mA},$ All inputs at 0 V		60	90	mA
$I_{LED}$	Supply current, LED			45	90	mA

NOTES: 3. Luminous intensity is measured with a light sensor and filter combination that approximates the CIE (International Commission on Illumination) eye-response curve.

4. This parameter is measured with  displayed, then again with  displayed.

5. These parameters are measured with  displayed.

## TYPICAL CHARACTERISTICS

### RELATIVE SPECTRAL CHARACTERISTIC

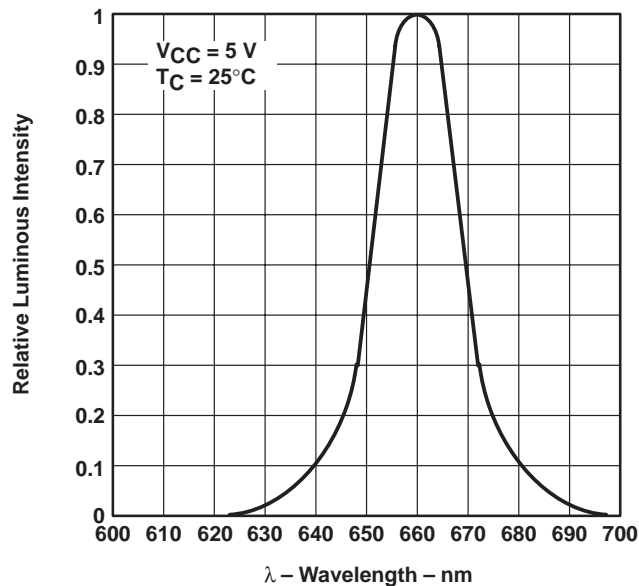

Figure 1



TYPICAL CHARACTERISTICS

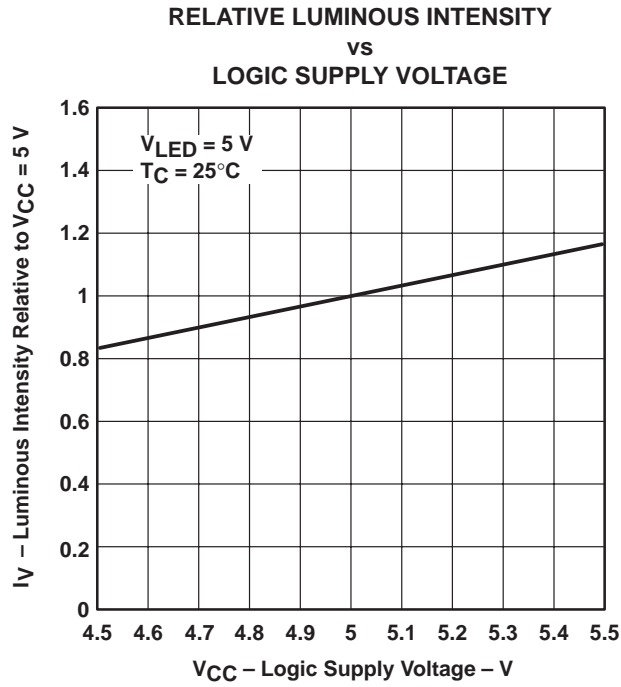

Figure 2

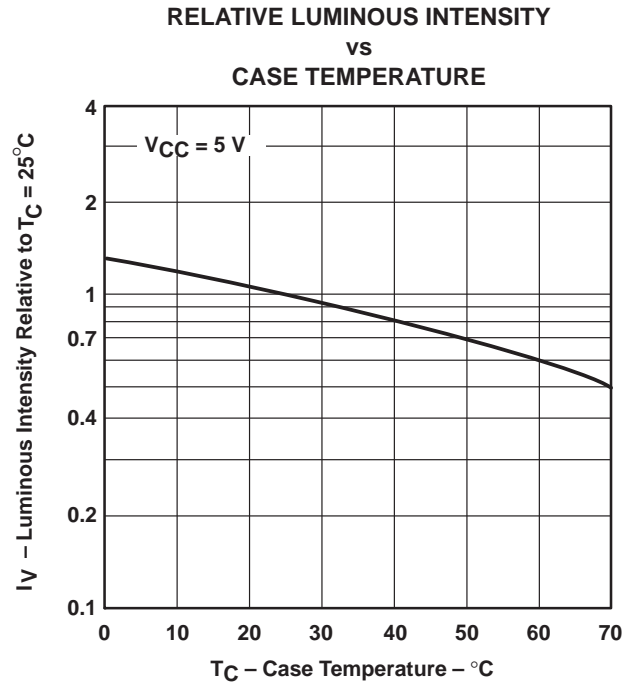

Figure 3

**PACKAGING INFORMATION**

Orderable Device	Status <sup>(1)</sup>	Package Type	Package Drawing	Pins	Package Qty	Eco Plan <sup>(2)</sup>	Lead/Ball Finish	MSL Peak Temp <sup>(3)</sup>
TIL311	NRND			14		TBD	Call TI	Call TI

<sup>(1)</sup> The marketing status values are defined as follows:

**ACTIVE:** Product device recommended for new designs.

**LIFEBUY:** TI has announced that the device will be discontinued, and a lifetime-buy period is in effect.

**NRND:** Not recommended for new designs. Device is in production to support existing customers, but TI does not recommend using this part in a new design.

**PREVIEW:** Device has been announced but is not in production. Samples may or may not be available.

**OBSOLETE:** TI has discontinued the production of the device.

<sup>(2)</sup> Eco Plan - The planned eco-friendly classification: Pb-Free (RoHS) or Green (RoHS & no Sb/Br) - please check <http://www.ti.com/productcontent> for the latest availability information and additional product content details.

**TBD:** The Pb-Free/Green conversion plan has not been defined.

**Pb-Free (RoHS):** TI's terms "Lead-Free" or "Pb-Free" mean semiconductor products that are compatible with the current RoHS requirements for all 6 substances, including the requirement that lead not exceed 0.1% by weight in homogeneous materials. Where designed to be soldered at high temperatures, TI Pb-Free products are suitable for use in specified lead-free processes.

**Green (RoHS & no Sb/Br):** TI defines "Green" to mean Pb-Free (RoHS compatible), and free of Bromine (Br) and Antimony (Sb) based flame retardants (Br or Sb do not exceed 0.1% by weight in homogeneous material)

<sup>(3)</sup> MSL, Peak Temp. -- The Moisture Sensitivity Level rating according to the JEDEC industry standard classifications, and peak solder temperature.

**Important Information and Disclaimer:**The information provided on this page represents TI's knowledge and belief as of the date that it is provided. TI bases its knowledge and belief on information provided by third parties, and makes no representation or warranty as to the accuracy of such information. Efforts are underway to better integrate information from third parties. TI has taken and continues to take reasonable steps to provide representative and accurate information but may not have conducted destructive testing or chemical analysis on incoming materials and chemicals. TI and TI suppliers consider certain information to be proprietary, and thus CAS numbers and other limited information may not be available for release.

In no event shall TI's liability arising out of such information exceed the total purchase price of the TI part(s) at issue in this document sold by TI to Customer on an annual basis.

## IMPORTANT NOTICE

Texas Instruments Incorporated and its subsidiaries (TI) reserve the right to make corrections, modifications, enhancements, improvements, and other changes to its products and services at any time and to discontinue any product or service without notice. Customers should obtain the latest relevant information before placing orders and should verify that such information is current and complete. All products are sold subject to TI's terms and conditions of sale supplied at the time of order acknowledgment.

TI warrants performance of its hardware products to the specifications applicable at the time of sale in accordance with TI's standard warranty. Testing and other quality control techniques are used to the extent TI deems necessary to support this warranty. Except where mandated by government requirements, testing of all parameters of each product is not necessarily performed.

TI assumes no liability for applications assistance or customer product design. Customers are responsible for their products and applications using TI components. To minimize the risks associated with customer products and applications, customers should provide adequate design and operating safeguards.

TI does not warrant or represent that any license, either express or implied, is granted under any TI patent right, copyright, mask work right, or other TI intellectual property right relating to any combination, machine, or process in which TI products or services are used. Information published by TI regarding third-party products or services does not constitute a license from TI to use such products or services or a warranty or endorsement thereof. Use of such information may require a license from a third party under the patents or other intellectual property of the third party, or a license from TI under the patents or other intellectual property of TI.

Reproduction of information in TI data books or data sheets is permissible only if reproduction is without alteration and is accompanied by all associated warranties, conditions, limitations, and notices. Reproduction of this information with alteration is an unfair and deceptive business practice. TI is not responsible or liable for such altered documentation.

Resale of TI products or services with statements different from or beyond the parameters stated by TI for that product or service voids all express and any implied warranties for the associated TI product or service and is an unfair and deceptive business practice. TI is not responsible or liable for any such statements.

Following are URLs where you can obtain information on other Texas Instruments products and application solutions:

<b>Products</b>		<b>Applications</b>	
Amplifiers	<a href="http://amplifier.ti.com">amplifier.ti.com</a>	Audio	<a href="http://www.ti.com/audio">www.ti.com/audio</a>
Data Converters	<a href="http://dataconverter.ti.com">dataconverter.ti.com</a>	Automotive	<a href="http://www.ti.com/automotive">www.ti.com/automotive</a>
DSP	<a href="http://dsp.ti.com">dsp.ti.com</a>	Broadband	<a href="http://www.ti.com/broadband">www.ti.com/broadband</a>
Interface	<a href="http://interface.ti.com">interface.ti.com</a>	Digital Control	<a href="http://www.ti.com/digitalcontrol">www.ti.com/digitalcontrol</a>
Logic	<a href="http://logic.ti.com">logic.ti.com</a>	Military	<a href="http://www.ti.com/military">www.ti.com/military</a>
Power Mgmt	<a href="http://power.ti.com">power.ti.com</a>	Optical Networking	<a href="http://www.ti.com/opticalnetwork">www.ti.com/opticalnetwork</a>
Microcontrollers	<a href="http://microcontroller.ti.com">microcontroller.ti.com</a>	Security	<a href="http://www.ti.com/security">www.ti.com/security</a>
		Telephony	<a href="http://www.ti.com/telephony">www.ti.com/telephony</a>
		Video & Imaging	<a href="http://www.ti.com/video">www.ti.com/video</a>
		Wireless	<a href="http://www.ti.com/wireless">www.ti.com/wireless</a>

Mailing Address: Texas Instruments  
Post Office Box 655303 Dallas, Texas 75265