



HESTORE.HU

elektronikai alkatrész áruház

EN: This Datasheet is presented by the manufacturer.

Please visit our website for pricing and availability at www.hestore.hu.

Ultrafast Soft Recovery Diode

Features

- Ultrafast Recovery
- 175°C Operating Junction Temperature
- Lead-Free ("PbF" suffix)

Benefits

- Reduced RFI and EMI
- Higher Frequency Operation
- Reduced Snubbing
- Reduced Parts Count

Description/ Applications

These diodes are optimized to reduce losses and EMI/ RFI in high frequency power conditioning systems. The softness of the recovery eliminates the need for a snubber in most applications. These devices are ideally suited for HF welding, power converters and other applications where switching losses are not significant portion of the total losses.

$$t_{rr} = 50\text{ns (typ)}$$

$$I_{F(AV)} = 60\text{Amp}$$

$$V_R = 400\text{V}$$

Absolute Maximum Ratings

Parameters	Max	Units
V_R Cathode to Anode Voltage	400	V
$I_{F(AV)}$ Continuous Forward Current, $T_C = 127^\circ\text{C}$	60	A
I_{FSM} Single Pulse Forward Current, $T_C = 25^\circ\text{C}$	600	
I_{FRM} ① Maximum Repetitive Forward Current	120	
T_J, T_{STG} Operating Junction and Storage Temperatures	- 55 to 175	$^\circ\text{C}$

① Square Wave, 20kHz

Case Styles

60EPU04PbF

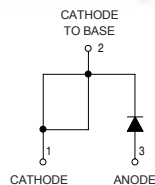

TO-247AC (Modified)

60APU04PbF

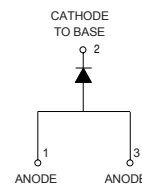

TO-247AC

Electrical Characteristics @ T_J = 25°C (unless otherwise specified)

Parameters	Min	Typ	Max	Units	Test Conditions
V _{BR} , V _r Breakdown Voltage, Blocking Voltage	400	-	-	V	I _R = 100μA
V _F Forward Voltage	-	1.05	1.25	V	I _F = 60A
	-	0.87	1.03	V	I _F = 60A, T _J = 175°C
	-	0.93	1.10	V	I _F = 60A, T _J = 125°C
I _R Reverse Leakage Current	-	-	50	μA	V _R = V _R Rated
	-	-	2	mA	T _J = 150°C, V _R = V _R Rated
C _T Junction Capacitance	-	50	-	pF	V _R = 400V
L _S Series Inductance	-	3.5	-	nH	Measured lead to lead 5mm from package body

Dynamic Recovery Characteristics @ T_J = 25°C (unless otherwise specified)

Parameters	Min	Typ	Max	Units	Test Conditions	
t _{rr} Reverse Recovery Time	-	50	60	ns	I _F = 1A, di _F /dt = 200A/μs, V _R = 30V	
	-	85	-		T _J = 25°C	
	-	145	-		T _J = 125°C	
I _R Peak Recovery Current	-	8.8	-	A	I _F = 60A V _R = 200V di _F /dt = 200A/μs	
	-	15.4	-			T _J = 125°C
Q _{rr} Reverse Recovery Charge	-	375	-	nC		T _J = 25°C
	-	1120	-			T _J = 125°C

Thermal - Mechanical Characteristics

Parameters	Min	Typ	Max	Units
R _{thJC} Thermal Resistance, Junction to Case			0.70	K/W
R _{thCS} ② Thermal Resistance, Case to Heatsink		0.2		
Wt Weight		5.5		g
		0.2		(oz)
T Mounting Torque	1.2 (10)		2.4 (20)	N*m (lbf.in)
Marking Device	60EPU04, 60APU04			

② Mounting Surface, Flat, Smooth and Greased

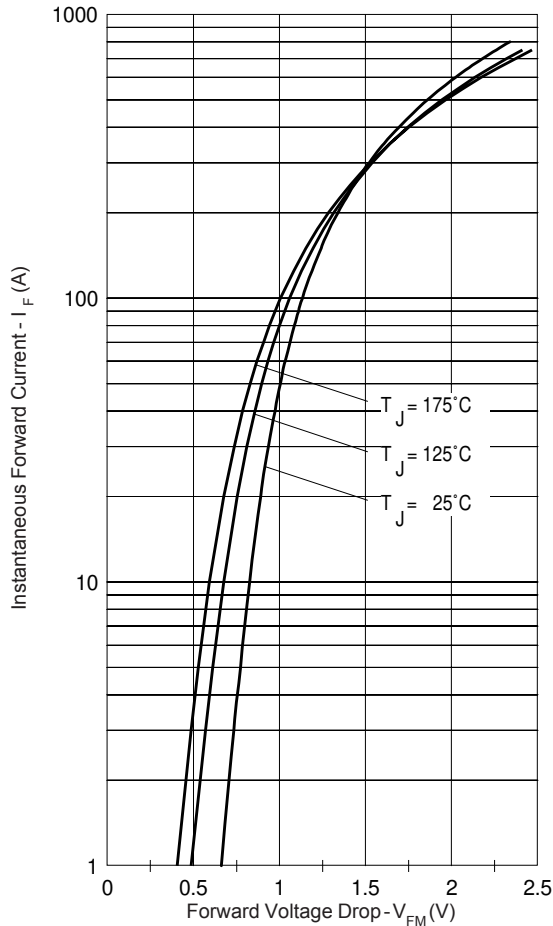

Fig. 1 - Typical Forward Voltage Drop Characteristics

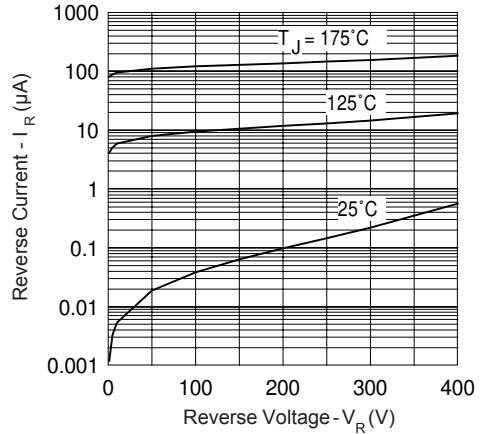

Fig. 2 - Typical Values Of Reverse Current Vs. Reverse Voltage

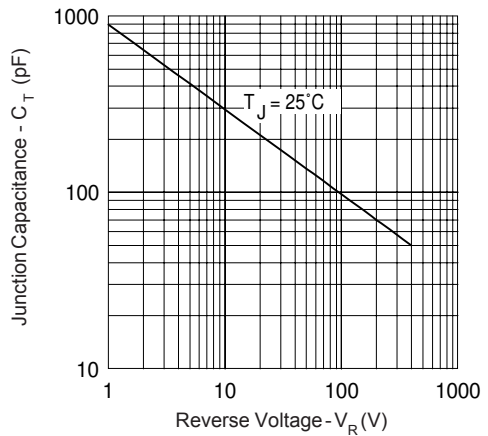

Fig. 3 - Typical Junction Capacitance Vs. Reverse Voltage

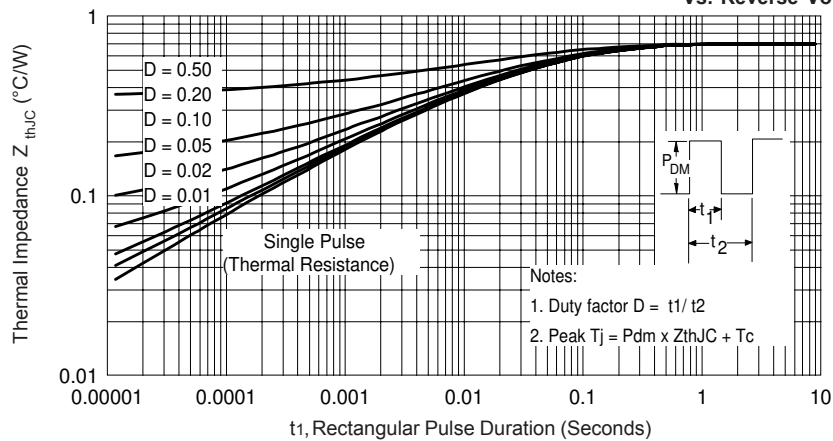

Fig. 4 - Max. Thermal Impedance Z_{thJC} Characteristics

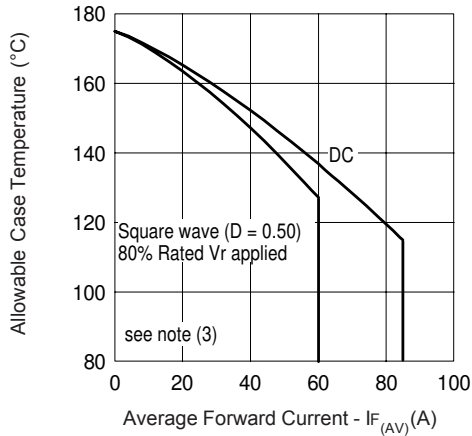

Fig. 5 - Max. Allowable Case Temperature Vs. Average Forward Current

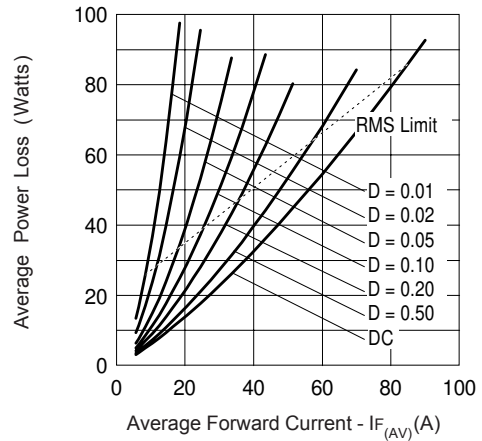

Fig. 6 - Forward Power Loss Characteristics

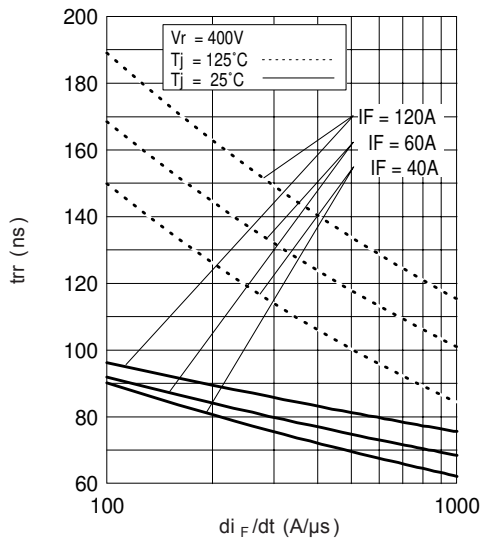

Fig. 7 - Typical Reverse Recovery time vs. di_F/dt

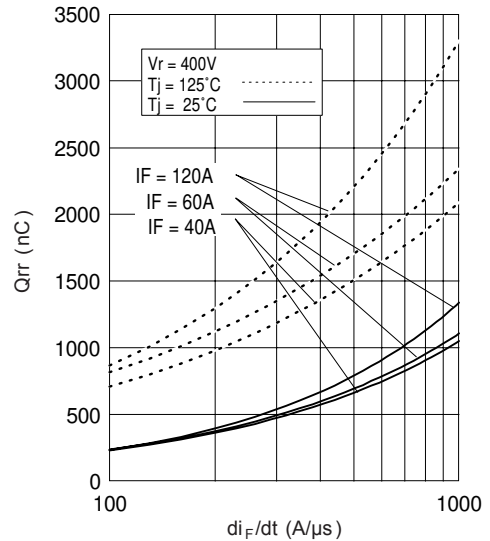

Fig. 8 - Typical Stored Charge vs. di_F/dt

(3) Formula used: $T_c = T_j - (P_d + P_{d_{REV}}) \times R_{thJC}$;

P_d = Forward Power Loss = $I_{F(AV)} \times V_{FM} @ (I_{F(AV)} / D)$ (see Fig. 6);

$P_{d_{REV}}$ = Inverse Power Loss = $V_{R1} \times I_{R1} (1 - D)$; $I_{R1} @ V_{R1} = 80\%$ rated V_R

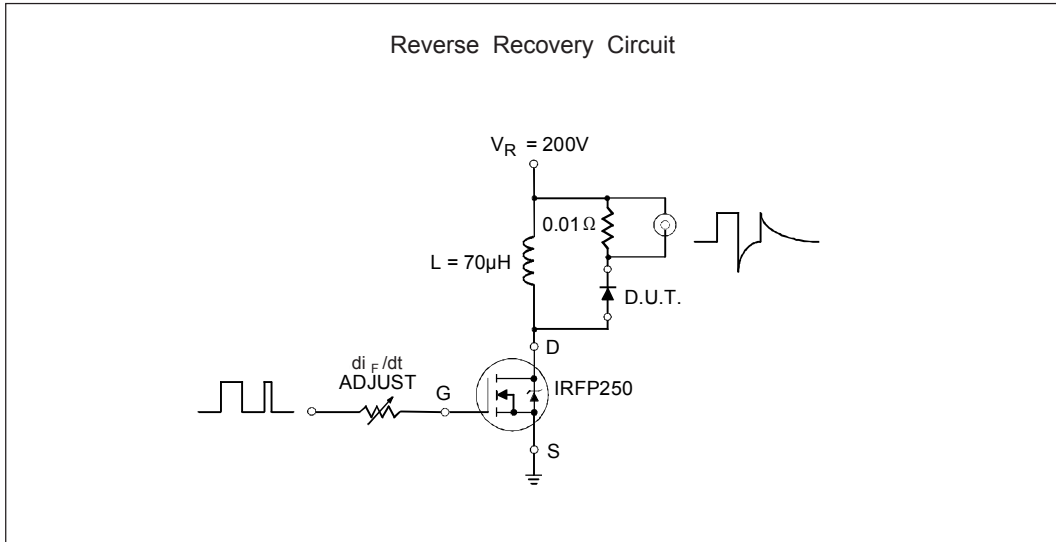

Fig. 9- Reverse Recovery Parameter Test Circuit

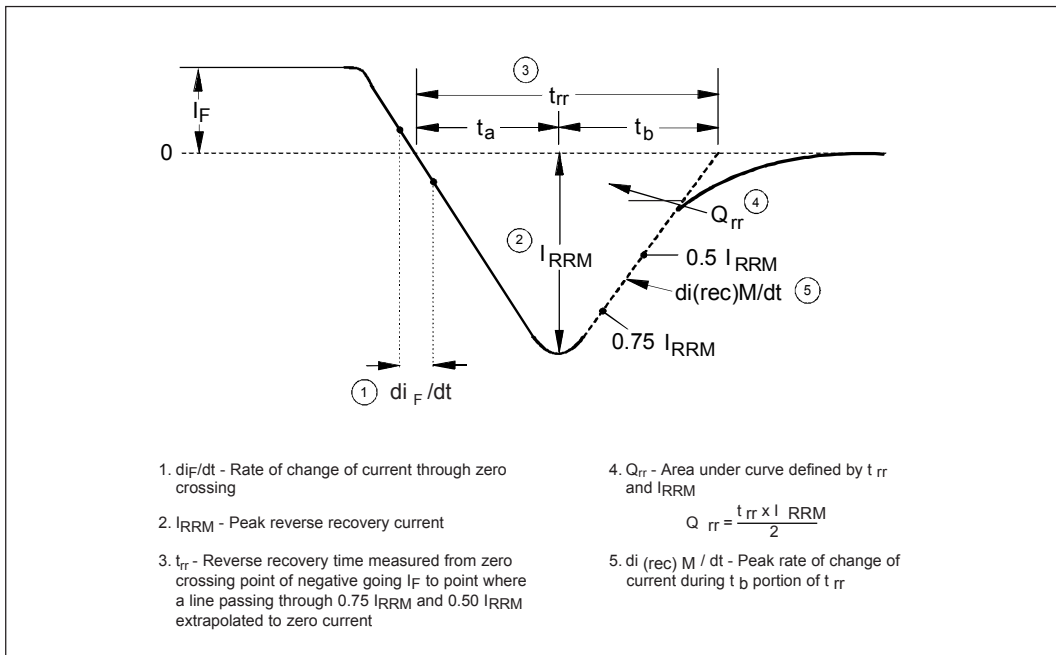
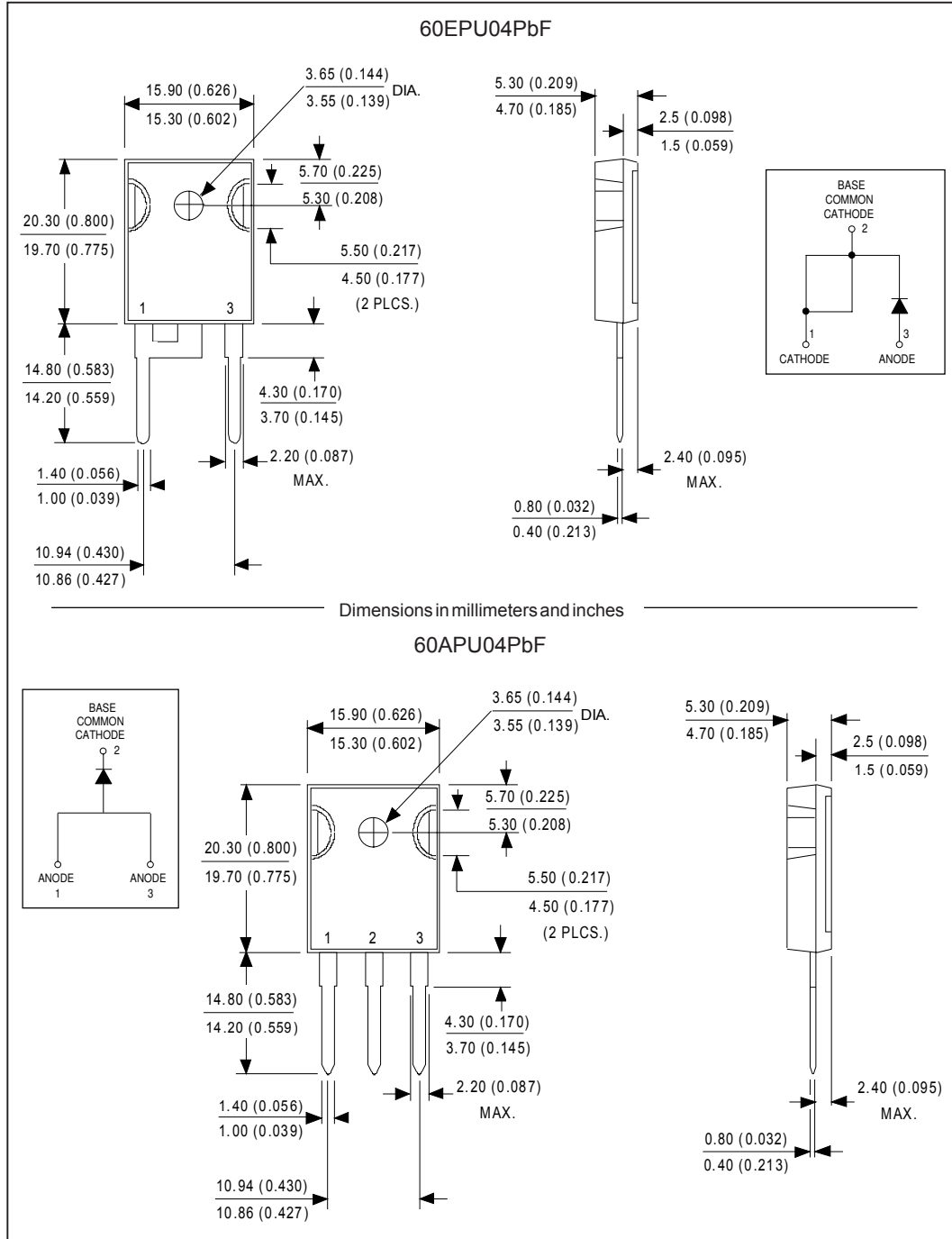

Fig. 10 - Reverse Recovery Waveform and Definitions

Outline Table



Marking Information

EXAMPLE: THIS IS A 60EPU04
 WITH ASSEMBLY
 LOT CODE 5657
 ASSEMBLED ON WW 35, 2000
 IN ASSEMBLY LINE "H"

INTERNATIONAL
RECTIFIER
LOGO

ASSEMBLY
LOT CODE

PART NUMBER

DATE CODE
 P = LEAD-FREE
 YEAR 0 = 2000
 WEEK 35
 LINE H

EXAMPLE: THIS IS A 60APU04
 WITH ASSEMBLY
 LOT CODE 5657
 ASSEMBLED ON WW 35, 2000
 IN ASSEMBLY LINE "H"

INTERNATIONAL
RECTIFIER
LOGO

ASSEMBLY
LOT CODE

PART NUMBER

DATE CODE
 P = LEAD-FREE
 YEAR 0 = 2000
 WEEK 35
 LINE H

Ordering Information Table

Device Code					
60	E	P	U	04	PbF
①	②	③	④	⑤	⑥
1	- Current Rating (60 = 60A)				
2	- Circuit Configuration: E = Single Diode A = Single Diode, 3 pins				
3	- Package: P = TO-247AC (Modified)				
4	- Type of Silicon: U = UltraFast Recovery				
5	- Voltage Rating (04 = 400V)				
6	- • none = Standard Production • PbF = Lead-Free				

60EPU04PbF, 60APU04PbF

Bulletin PD-21080 08/05

International
IOR Rectifier

Data and specifications subject to change without notice.
This product has been designed and qualified for Industrial Level and Lead-Free.
Qualification Standards can be found on IR's Web site.

International
IOR Rectifier

IR WORLD HEADQUARTERS: 233 Kansas St., El Segundo, California 90245, USA Tel: (310) 252-7105
TAC Fax: (310) 252-7309
08/05



Notice

The products described herein were acquired by Vishay Intertechnology, Inc., as part of its acquisition of International Rectifier's Power Control Systems (PCS) business, which closed in April 2007. Specifications of the products displayed herein are pending review by Vishay and are subject to the terms and conditions shown below.

Specifications of the products displayed herein are subject to change without notice. Vishay Intertechnology, Inc., or anyone on its behalf, assumes no responsibility or liability for any errors or inaccuracies.

Information contained herein is intended to provide a product description only. No license, express or implied, by estoppel or otherwise, to any intellectual property rights is granted by this document. Except as provided in Vishay's terms and conditions of sale for such products, Vishay assumes no liability whatsoever, and disclaims any express or implied warranty, relating to sale and/or use of Vishay products including liability or warranties relating to fitness for a particular purpose, merchantability, or infringement of any patent, copyright, or other intellectual property right.

The products shown herein are not designed for use in medical, life-saving, or life-sustaining applications. Customers using or selling these products for use in such applications do so at their own risk and agree to fully indemnify Vishay for any damages resulting from such improper use or sale.

International Rectifier®, IR®, the IR logo, HEXFET®, HEXSense®, HEXDIP®, DOL®, INTERO®, and POWIRTRAIN® are registered trademarks of International Rectifier Corporation in the U.S. and other countries. All other product names noted herein may be trademarks of their respective owners.