



HESTORE.HU

elektronikai alkatrész áruház

EN: This Datasheet is presented by the manufacturer.

Please visit our website for pricing and availability at www.hestore.hu.



SIDE VIEW OF BOX

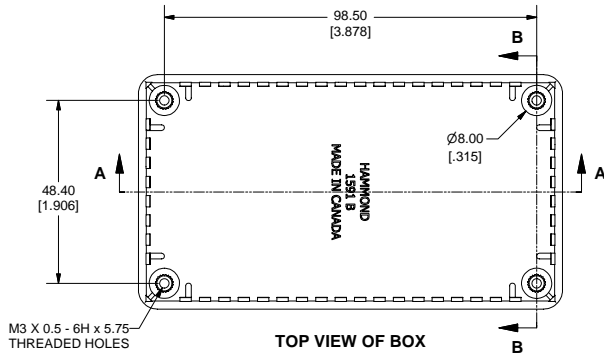

TOP VIEW OF BOX

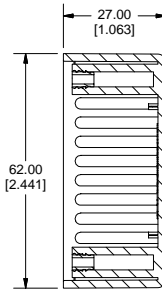

SECTION B-B
SCALE 1 : 1

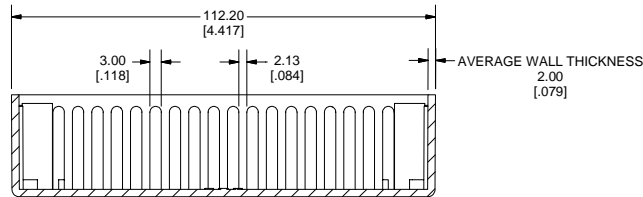

SECTION A-A
SCALE 1 : 1



SIDE OF LID

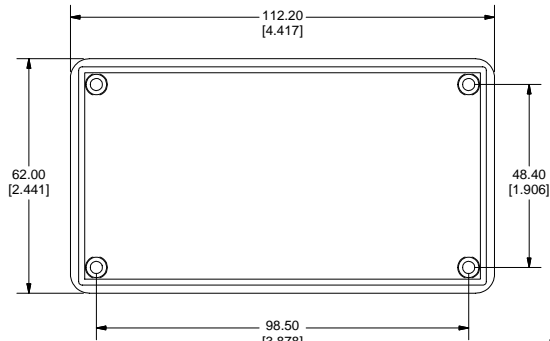

BOTTOM OF LID

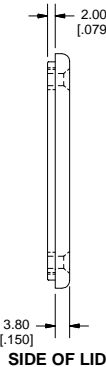

SIDE OF LID

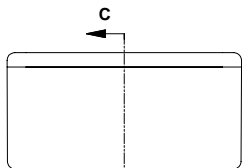

END VIEW OF ASSEMBLY

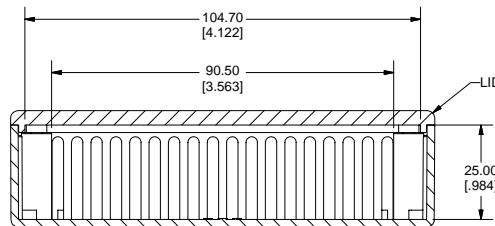

SECTION C-C
SCALE 1 : 1

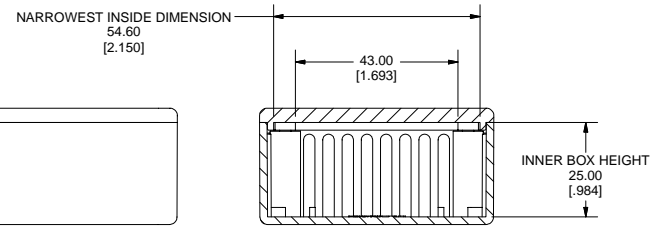

SECTION D-D
SCALE 1 : 1

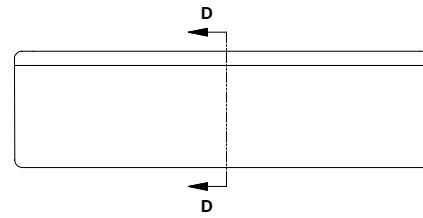

SIDE VIEW OF ASSEMBLY

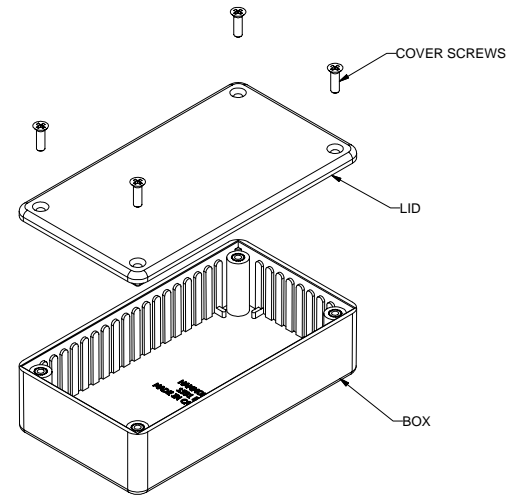

1591B

PART NUMBERS			
1591B Enclosures			
Material	Colour	Part Number	
ABS	Beige	1591BBG	
	Black	1591BSK	
	Blue	1591BBU	
	Grey	1591BGY	
	Black Shielded	1591RBBK	
GP ABS	Black	1591BSBK	
Translucent	Ice Blue	1591BTBU	
	IR Red	1591BTRD	
	Crystal Clear	1591BTCL	
Polycarbonate	Crystal Clear	1591BTCL	
	Accessories		
	Description	Part Number	
Used with ABS and Translucent Polycarbonate Enclosures	PC Board Card Adapters	See Accessories Section	
	Flange Kits	See Accessories Section	
	Replacement Screws, nickel plated M3 - 0.5 x 10mm, Pack of 100,	1591MS100	
	Belt/Pocket Clip, w/ nylon screws (insulated to avoid interference) and mounting template	1599CLIP - Black 1599CLIPGY - Grey	
	Clear Lids - clear, flame retardant polycarbonate - Lid ONLY	1591BC	
	Used with GP ABS Enclosure	PC Board Card Adapters	See Accessories Section
		Flange Kits	See Accessories Section
		Belt/Pocket Clip, w/ nylon screws (insulated to avoid interference) and mounting template	1599CLIP - Black 1599CLIPGY - Grey
		Replacement Screws, self tapping, black oxide, #4 x 0.5, Pack of 100	1591TS100BK
	Clear Lids - clear, flame retardant polycarbonate - Lid ONLY	1591BC	
Required Torque on Fasteners (no lubrication)			
M3 - 0.5 x 10mm Screws	30-40 cN*m		
#4 x 0.5 Screws	30-40 cN*m		



www.hammondmfg.com