



HESTORE.HU

elektronikai alkatrész áruház

EN: This Datasheet is presented by the manufacturer.

Please visit our website for pricing and availability at www.hestore.hu.

Instruction of Solar Charge Controller

User's Manual



12V/24V 10A/20A/30A/40A

Dear Users:

Thank you for selecting our product. Please read this manual carefully before you use this product.

The controller is for off-grid solar system and control the charging and discharging of the battery. Main function is protecting battery. The intelligent charging process has been optimized for long battery life and improved system performance.

Major Functions

The features are listed below:

- Automatic Identification System Voltage, 12V 24V auto recognition
- Humanized LCD displaying and double button operation of man-machine interface.
- Completed technical data for setup and modify.
- High efficiency intelligent PWM 3stage charging
- The load control mode can be selected, the timer function can be reset for street light at night.
- Reliable over voltage protection、short circuit protection、over load protection、overcharge protection、over-discharge protection.
- Accurate temperature compensation, correcting the

charging and discharging voltage automatically, improving the battery lifetime.

- Roundly reverse connected protection.
- Solar Panels, Battery, Solar Charge Controller positive poles are all connected together, adopting negative MOSFET in series control circuit.

Important Safety Information

- It is better to install the controller in the room. If installed the controller outside, please keep the environment dry, avoid direct sunlight.
- The controller will be hot in process of working, please keep the environment ventilation, away from flammable.
- The open circuit voltage of solar panel is too high, (especially 24V system), please take care.
- The battery has acidic electrolysis, please put on goggles during installation. If you accidentally exposed to the electrolysis, please rinse with water.
- The battery has huge power, prohibit any conductor

short circuit the positive and negative pole of battery. Suggest to adding a fuse between battery and controller. (Slow motion type, the action current of the fuse should be 1.5 times rated current of controller.)



The suggestion of using

- The controller could detect the temperature of environment to adjust the voltage of charging, so that the controller should be closed to battery as near as possible.
- Recommend system current density of cables less than $3A/mm^2$.
- Try to use multi strand copper wire in order to connecting with the terminal firmly. Loose power connection and/or corroded wires may result in resistive connections that melt wire insulation, burn surrounding materials or even cause fire.
- The battery should be full charged each month. Or the battery will be destroyed.

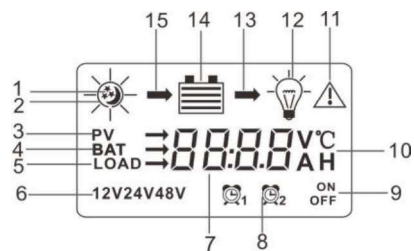
The feature of LCD graphic symbol



1. The default night display of controller: When the solar panel input voltage have been detected by controller less than sensor identification point voltage, this graphic symbol will be light.
2. The default daytime display of controller: When the solar panel input voltage have been detected by controller more than sensor identification point voltage, this graphic symbol will be light.
3. The indicator of PV array parameter: When the solar panels data was displaying, this graphic symbol will be light. For example the voltage of solar panel.

4. The indicator of battery parameter: When the battery parameter was displaying, this graphic symbol will be light. For example the voltage of battery, temperature of battery.
5. The indicator of load parameter: When the load parameter was displaying, this graphic symbol will be light.
6. System Voltage: When the LCD shows different system voltage, the controller will adjust the technical data automatically.
7. Numerical Display Area
8. Timer Setting Function
9. Switch Graphic Symbol.
10. Unit Symbol Value
11. Warning: When there is fault, this graphic symbol will be light.
12. The indicator of Load status:  Load on,  Load off.
13. The indicator of Output power: When the load terminal have output, this graphic symbol will be light.

14. The indicator of capacity of battery: When the battery was in different capacity, the strip-type will show.
15. The indicator of charge status: When the controller is charging, the symbol will be light, float charge will be flash, no charging no display.

Installation Instructions

■ Controller Fixed

- 1) The controller should be installed well-ventilated place, avoid direct sunlight, high temperature and do not install in location where water can enter the controller.
- 2) Please select correct screw to fix the controller on the wall or other platform. Screw M4 or M5, Screw cap diameter less than 10mm.
- 3) Please reserve enough space between the wall and controller, to allow for cooling and cable connection.
- 4) The mounting holes distance is 155.8mm*63mm, diameter of the hole is 5mm.

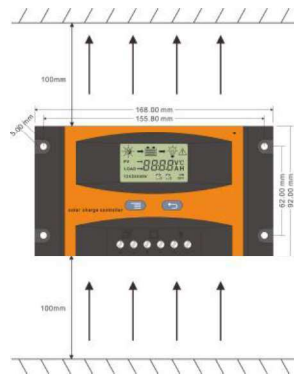

■ Controller Connection

- 1) **All terminals are in tight status after factory, in order to well connected, please loose all terminals at first.**
- 2) The following order of connection please do not free change, or cause system voltage recognition fault.
- 3) As figure, first connected the battery to controller correct poles. In order to avoid short circuit, please screw the cable of battery to the controller in advance, then connected to battery poles secondly. If your

connection is correct, the LCD displaying will show battery voltage and other technical data. If LCD no indicate, please check the fault. The length of cable between battery and controller as shorter as possible. Suggest to 30CM -100CM.

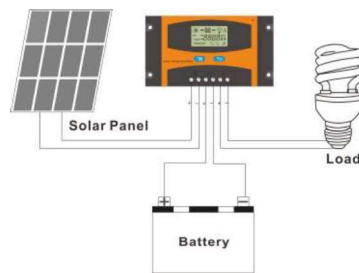

- If short circuit happened on the terminals of controller, it will be result in fire or explode. Please be careful. (We strongly suggest to connecting a fuse at the battery side 1.5time of rated current of controller.)
- If the battery reverse connection, the output of controller also same with battery polarity, please do not



connect any load with controller at that time, or the load and controller will be destroyed.

- 4) As figure, connected solar panels with controller correctly, if the connection is successful and sunshine is full, the LCD will show solar panel and an arrow from solar panel to battery will be light.

The voltage of solar panel is very high under sunshine, high voltage can cause injury or destroy controller. As figure, connected loads with controller correctly.



In order to avoid injury from load voltage, please close to the output of controller with button at first, then connected the load on the controller. The controller do not offer reverse connection protection for load, so please take care, reverse connection for load will be destroy bulb.



■ **About ground connection of solar system**

Please noted, this solar charge controller designed by all positive connection, all components inside the controller are

positive combined together. If your solar system needs ground connection, please let positive ground connection.

Warning: For some force to ground connected system, such as solar communication system, portable solar system, they are negative ground connected, at this time please do not positive connected, or can cause short circuit.



Operation and Indication

■ Main interface

- The controller will have 1s initialization interface after electrified, then go into main interface.

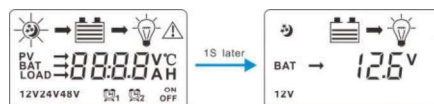

- If no operation at main interface inner 20s, the main interface will be auto exchange during voltage of battery, voltage of solar panel, temperature of environment eachinterface keep 3s. Long press

“↔”more than 5s at main interface, it will speed auto exchange. Loose button will stop speed.

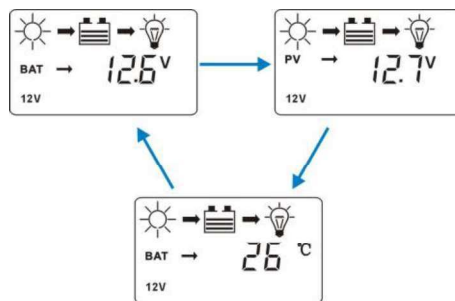

- Press “↔”under main interface could open or close the load output.

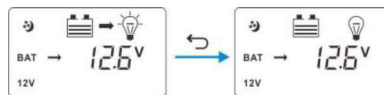

- Press “☰”button could join into next menu under main interface

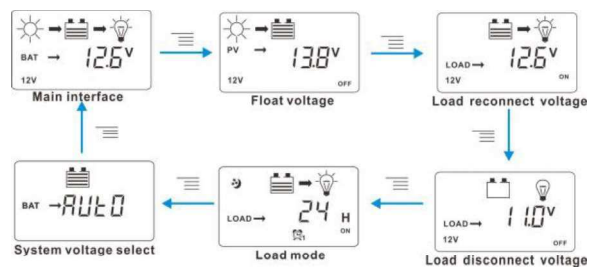

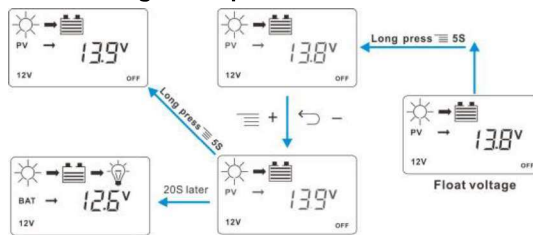

a) Float Voltage Set up



This parameter is High Voltage Disconnection (HVD) voltage. (Boost state voltage will be increase 0.6V base on HVD) The controller will be started PWM function at this point (HVD), limited voltage rising.

Press “≡” join in float voltage menu. Long press

“”button $\geq 5S$, the parameter on the interface will be flash, here is set up state. Loose the button, press “” button again could operate plus data, press “Pod” button could operate minus data. After finish the needed technical data, long press “”button again $\geq 5S$, the parameter save and come out set up state. If 20s no any operation, automatically back to main interface.

b) Low Voltage Reconnection Voltage (LVR)

When the voltage of battery is low, the control will stop offer power to the load. If the controller needs reconnected the output, the voltage of battery must be higher

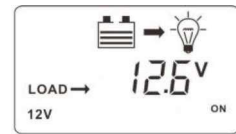

Load reconnect voltage

than LVD voltage or press “”button force to release. The procedure is same with (a).

c) Low Voltage Disconnection Voltage

When the voltage of battery is low, the load output will be cut off. When the controller detected the battery voltage was less than LVD point, the cut off function will be immediately

working. At the same time, the status of controller is in lock. Users have to charge the battery, when the battery voltage is higher than LVD

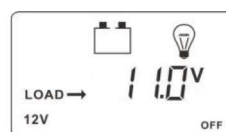

Load disconnect voltage

voltage or press "↶" button force to release. The load output will be back. The procedure is same with (a).



Above a、 b、 c three parameter default data was fully considered by designer according to the actual use. Generally users don't need to adjust. Please must be refer to battery supplier's suggestion, or the battery will be damaged or irreparable destroy.

d) Load Working Mode Selection

The control default load working 24hours. When the Load Working Time set to 24hours, the load will keep

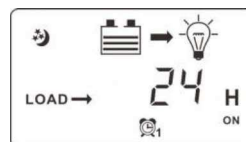

Load mode

working 24hours in no fault status. When the load working

time set to $\leq 23H$, it means the load start timer or sensor function. If the battery capacity is enough, the load will be started at sunset. The load will work under timer setting hours or stop working till sunrise.



When the load join into timer or sensor mode, if the reset working time more than actual night time, the load output will be closed at sunrise, although the working time is not reach to setting hours. For example, the local actual night time is 10hours, user reset the working time at night is 12hours, but 10hours later the output will be closed automatically, the balance hours will be back to zero. The load will be working with next sunset signal.

e) System Voltage Select

This parameter designed for customers wide range voltage requiring. The default display “**U0**” system voltage 12/24v auto.

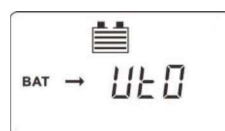

System voltage select

When battery voltage is more than 18V, the controller will be auto change to 24V system with 24V control data. When battery voltage is less than 18V, the controller will be auto change to 12V system with 12V control data.

If the system voltage is set to “1”, the controller will be work under 12V version forever. The battery voltage is not valid. The reset data will be working after reconnection.

If the system voltage is set to “2”, the controller will be work under 24V version forever. The battery voltage is not valid. The reset data will be working after reconnection.

■ Protection Function

● Battery Low Voltage Protection(LVD)

When the battery voltage less than 11V, the LVD protection started. The output cut off, at the same time the battery

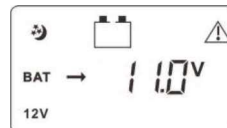

symbol and warning flash. Please increase charge current or increase charge time. When the battery voltage more than 12.6V, the protection will be closed. The load output is come

back or press “←” button force to unlock at main interface.

- **Battery Over Voltage Disconnection (OVD)**

When the voltage of battery more than 16.5V, the over voltage protection will be started.

The load cut off, at the same time the load and warning symbol

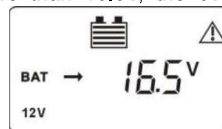

flash. When the voltage of battery was decreased to 15V, the protection will be release. The output of the load is back.

- **Load Over Current Protection**

When the load is short circuit or overload, the output cut off, at the same time the load symbol

and warning flash. Please confirm if there is short circuit on

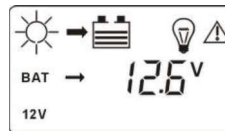

the load terminal, decrease the

power of the load. 30s later the controller will be auto restart with unlock, or press “←” button force to unlock at main interface.

- **High Voltage Disconnection Protection (HVD)**

When the battery was charged to 13.8V, the PWM function will be started, the charge symbol will be flash, and the voltage of battery has been limited.

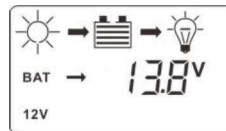

Common Fault and Handling

Fault Phenomenon	Possible Reason	Solution
LCD no display after connected with battery	<ul style="list-style-type: none"> ● Battery Low ● Battery Reverse Connection ● The connection cut off 	Please confirm the voltage of battery reconnect the controller with battery firmly and correctly.

Full of sunshine vertical on solar panel, no solar symbol and no charge symbol on LCD.	The solar panel connection open circuit, short circuit, or reverse connected	Please check the cable of solar panels if they are correct connection and firmly.
The controller displaying LVD	The battery is over discharging	Please check the system design is reasonable or not. If there is discharging capacity more than charging.
The controller displaying HVD	The voltage of battery is high	Please first cut off the solar panel and see if the voltage get down normal level. If the fault do not finish, please cut off the battery with controller and reconnect again.
The controller displaying Over Current Protection	The load is short circuit, or over load or high surge power	Please check the load cables have short circuit, the power of the load over rated design, the surge power of load too high.

Technical Data

Mode	
System Voltage	12V/24V
Max. Input Voltage of solar panel	55V
Self-consumption	≤12mA

Max. charge current	10A	20A	30A
Max. discharge current	10A	20A	30A
LVD	11.0V ADJ 9V....12V ; ×2 24V		
LVR	12.6V ADJ 11V....13.5V ; ×2 24V		
Float Voltage	13.8V ADJ 13V....15V ; ×2 24V		
Boost charging	14.4V ; ×2 24V Battery Voltage less than 12Vstart boost charging 2 hours		
Battery Over Voltage Protection	16.5V ; ×2 24V		
Reverse Connection Protection	yes		
Load Over Current Protection	Yes, each two minutes restart once		
Charge Type	PWM		
Temperature Compensation	-24 mV/°C for 12V system ; ×2 24V		
Working Temperature	-20°C---+55°C		
Terminal Scale	28—10 AWG		
Waterproof grade	IP32		
Size	168 mm×92 mm×41.5mm		
Netweight	320g		

Subject to change without notice
Version:201401