



**HESTORE.HU**

elektronikai alkatrész áruház

**EN:** This Datasheet is presented by the manufacturer.

Please visit our website for pricing and availability at [www.hestore.hu](http://www.hestore.hu).

# SMD Terminal Blocks

Small is Big



# SMD Terminal Blocks

A compact and flat printed circuit board connection is required to achieve the most uniform light distribution, while minimizing shadowing. WAGO's SMD terminal blocks, with their combination of flat design and wide range of potential uses, completely cover these functionality demands.

Furthermore, assembling 1-, 2- and 3-pole terminal blocks without losing any poles provides complete flexibility with a reduced number of variants. All SMD terminal blocks come in tape-and-reel packaging to ensure full integration into an automated assembly process.

## Applications:

The SMD family offers many advantages allowing for a wide range of applications. From compact, conventionally wired LED spotlights up to industrially wired, recessed ceiling luminaires, WAGO's three SMD terminal block series are the perfect connection between driver and module.

**The terminal blocks accommodate a broad range of conductors making them highly versatile for worldwide applications.**



## Benefits:

- Low profile minimizes on-board shadowing
- Direct push-in of solid conductors
- Terminal strips of different lengths can be mounted without losing any poles allowing for a reduced number of variants and lower production costs
- Available in 1-3 pole configurations
- Delivery in tape-and-reel packaging for full integration into SMT soldering process
- Potential for significant savings via automated pick-and-place assembly



# Surface Mount Technology

Surface Mount Technology (SMT) means soldering electronic components directly onto PCB surface pads without drilling holes. The basic SMT process consists of applying solder paste to the PCB via solder dispensing equipment, screen or stencil printing.

SMT assembly is performed using fully automated placement machines. Surface mount components are soldered to the board in infrared, convection or vapor phase ovens.

## Reflow Soldering Process:

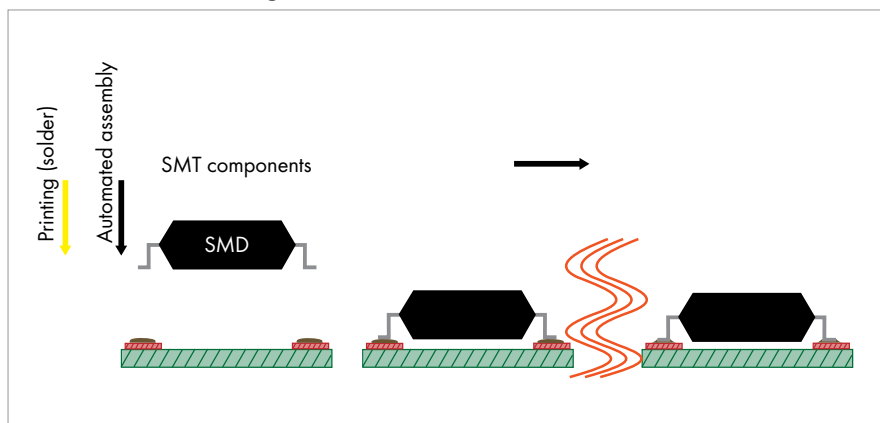

# 2059 Series

## For the Smallest Installation Spaces

- Low profile of just 2.7 mm
- Pin spacing: 3 mm
- Terminates solid conductors from 26 to 22 AWG (0.14 - 0.34 mm<sup>2</sup>)
- Direct push-in of solid conductors
- Easy conductor removal via operating tool
- Rated data: 160 V, 2.5 kV/2 (III), 3 A
- Available in 1-, 2- and 3-pole configurations
- Group arrangement is possible without losing any poles
- Available in tape-and-reel packaging

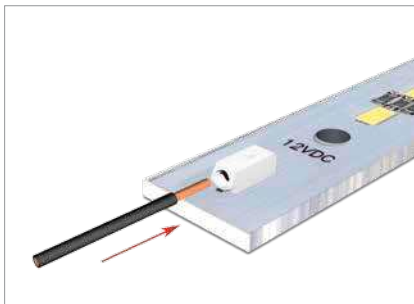

Inserting solid conductors via push-in termination.

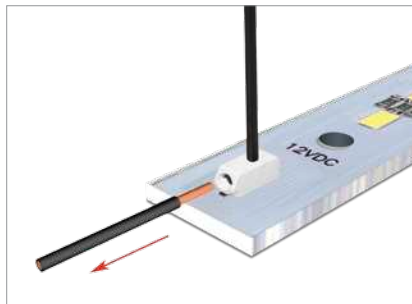

Easy conductor removal, e.g., via 206-859 operating tool.



### 2059 Series, 3 mm Pin Spacing

Pin Spacing	3 mm / 0.118 in			Conductor Data	
Ratings per	IEC/EN 60664-1			Connection technology	<b>PUSH WIRE®</b>
Overtoltage category	III	III	II	Conductor size: solid	0.14 - 0.34 mm <sup>2</sup>
Pollution degree	3	2	2	AWG	26 - 22 "sol."
Rated voltage	63 V	160 V	320 V	Strip length	4 - 5.5 mm / 0.16 - 0.22 in
Rated surge voltage	2.5 kV	2.5 kV	2.5 kV		
Rated current	3 A	3 A	3 A		

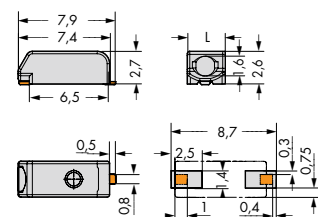

$$L = (\text{pole no.} \times \text{pin spacing}) - 0.1 \text{ mm}$$

Pole No.	Item No.	Pack.	Unit
<b>SMD terminal blocks in tape-and-reel packaging, white</b>			
Reel diameter: 330 mm			
1	2059-301/998-403	31800	(12 x 2650)
2	2059-302/998-403	21000	(12 x 1750)
3	2059-303/998-403	21000	(12 x 1750)

# 2060 Series

## For Manual and Automated Wiring Systems

- 4.5 mm high
- Pin spacing: 4 mm
- Terminates conductors from 24 to 18 AWG (0.2 - 0.75 mm<sup>2</sup>)
- Direct push-in of solid conductors
- Push-buttons for easy connection and removal of all types of conductors
- Rated data: 160 V, 2.5 kV/2 (III), 9 A
- Available in 1-, 2- and 3-pole configurations
- Group arrangement is possible without losing any poles
- Available in tape-and-reel packaging

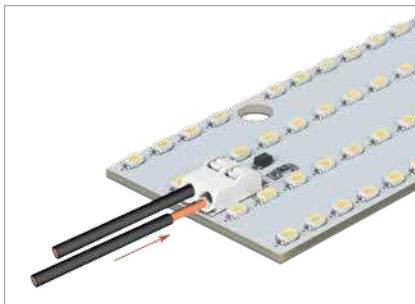

Inserting solid conductors via push-in termination.

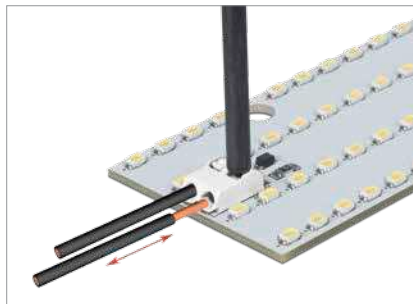

Inserting/removing fine-stranded conductors by lightly pressing on push-button (e.g., using a 206-860 operating tool).



### 2060 Series, 4 mm Pin Spacing

Pin Spacing	4 mm / 0.157 in			Conductor Data	
Ratings per	IEC/EN 60664-1			Connection technology	<b>CAGE CLAMP® S</b>
Overtoltage category	III	III	II	Conductor size: solid	0.2 - 0.75 mm <sup>2</sup>
Pollution degree	3	2	2	Conductor size: fine-stranded	0.2 - 0.75 mm <sup>2</sup>
Rated voltage	63 V	160 V	320 V	Conductor size: fine-stranded	0.25 - 0.34 mm <sup>2</sup> (with insulated ferrule)
Rated surge voltage	2.5 kV	2.5 kV	2.5 kV	Conductor size: fine-stranded	0.25 - 0.34 mm <sup>2</sup> (with uninsulated ferrule)
Rated current	9 A	9 A	9 A	AWG	24 - 18
Approvals per	UL 1977			Strip length	7 - 9 mm / 0.28 - 0.35 in
Rated voltage, 1-pole	600 V				
Rated voltage, 2 or more poles	250 V				
Rated current (UL)	9 A				

Pole No.	Item No.	Pack.	Unit
<b>SMD terminal blocks with push-buttons in tape-and-reel packaging, white</b>			
			Reel diameter: 330 mm
1	2060-451/998-404	13500	(9 x 1500)
2	2060-452/998-404	9000	(9 x 1000)
3	2060-453/998-404	6750	(9 x 750)

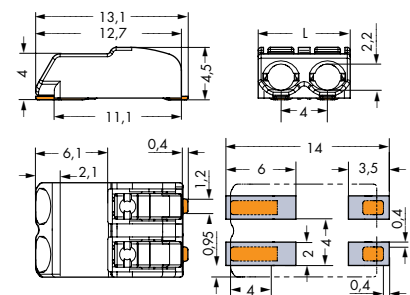

# 2060 Series

## Pin Spacing: 8 mm

The 2-pole SMD terminal block with 8 mm pin spacing has been added to WAGO's portfolio, providing higher rated voltages up to 630 V/6 kV/2 in LED and industrial applications.



## Board-To-Board Link

Besides standard wiring, several LED modules can be easily assembled into a single string using board-to-board connection links. This minimizes labor (no manual wiring) and materials needed for connecting LED modules.



## THR and Wave Soldering

WAGO's 2060 Series THR PCB Terminal Blocks with soldering pins are ideally suited for THR and wave soldering. The 2060 Series THR terminal blocks are available in light gray and black. Additional information at [www.wago.com/2060](http://www.wago.com/2060)



Assembly: Place PCBs on a flat surface and connect terminal blocks on adjoining PCBs via board-to-board link.  
Disassembly: Pull PCBs apart (max. 10 connections/disconnections). The PCBs must be secured.

### 2060 Series, Board-to-Board Connection Link

Pin Spacing	4 mm / 0.157 in			Pole No.	Item No.	Pack. Unit
Ratings per	IEC/EN 60664-1			<b>Board-to-board link for SMD terminal blocks with push-buttons</b>		
Overvoltage category	III	III	II	1	<b>2060-901</b>	1500
Pollution degree	3	2	2	2	<b>2060-902</b>	500
Rated voltage	63 V	160 V	320 V	3	<b>2060-903</b>	375
Rated surge voltage	2.5 kV	2.5 kV	2.5 kV			
Rated current	9 A	9 A	9 A			

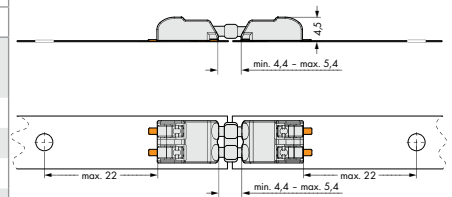

### 2060 Series, 8 mm Pin Spacing

Pin Spacing	8 mm / 0.314 in			Conductor Data	
Ratings per	IEC/EN 60664-1			Connection technology	<b>CAGE CLAMP® S</b>
Overvoltage category	III	III	II	Conductor size: solid	0.2 - 0.75 mm <sup>2</sup>
Pollution degree	3	2	2	Conductor size: fine-stranded	0.2 - 0.75 mm <sup>2</sup>
Rated voltage	400 V	630 V	1000 V	Conductor size: fine-stranded	0.25 - 0.34 mm <sup>2</sup> (with insulated ferrule)
Rated surge voltage	6 kV	6 kV	6 kV	Conductor size: fine-stranded	0.25 - 0.34 mm <sup>2</sup> (with uninsulated ferrule)
Rated current	9 A	9 A	9 A	AWG	24 - 18
Approvals per	UL 1977			Strip length	7 - 9 mm / 0.28 - 0.35 in
Rated voltage	600 V				
Rated current (UL)	9 A				

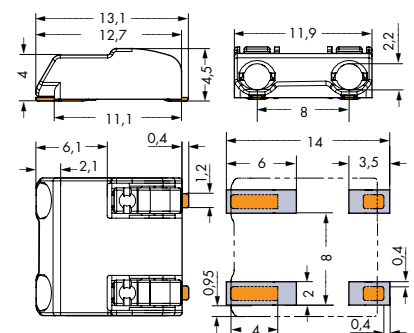

Pole No.	Item No.	Pack. Unit
<b>SMD terminal blocks with push-buttons in tape-and-reel packaging, white</b> Reel diameter: 330 mm		
2	2060-852/998-404	6750 (9 x 750)

# 2061 Series

## For Direct Power System Feed-In

- 5.6 mm high
- Pin spacing: 6 mm
- Terminates conductors from 20 to 16 AWG (0.5 - 1.5 mm<sup>2</sup>)
- Direct push-in of solid conductors
- Push-buttons for easy connection and removal of all types of conductors
- Well-suited for automated wiring systems
- Rated data 320 V, 4 kV/2 (III), 17,5 A
- 300 V UL 1059
- Available in 1-, 2- and 3-pole configurations
- Group arrangement is possible without losing any poles
- Available in tape-and-reel packaging



Application example: LED driver

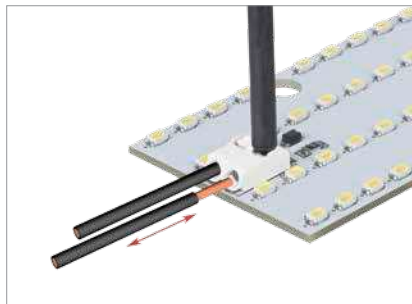

Inserting/removing fine-stranded conductors by lightly pressing on push-button (e.g., using a 206-861 operating tool).



### 2061 Series, 6 mm Pin Spacing

Pin Spacing	6 mm / 0.24 in			Conductor Data	
Ratings per	IEC/EN 60664-1			Connection technology	<b>CAGE CLAMP® S</b>
Overvoltage category	III	III	II	Conductor size: solid	0.5 - 1.5 mm <sup>2</sup>
Pollution degree	3	2	2	Conductor size: fine-stranded	0.5 - 1.5 mm <sup>2</sup>
Rated voltage	250 V	320 V	630 V	Conductor size: fine-stranded	0.5 - 0.75 mm <sup>2</sup> (with insulated ferrule)
Rated surge voltage	4 kV	4 kV	4 kV	Conductor size: fine-stranded	0.5 - 0.75 mm <sup>2</sup> (with uninsulated ferrule)
Rated current	17,5 A	17,5 A	17,5 A	AWG	20 - 16
Approvals per	UL			Strip length	7 - 10 mm / 0.28 - 0.39 in
Use group UL 1059	B	C	D		
Rated voltage, 1-pole	600 V	-	600 V		
Rated voltage, 2 or more poles	300 V	-	300 V		
Nominal current UL	10 A	-	10 A		

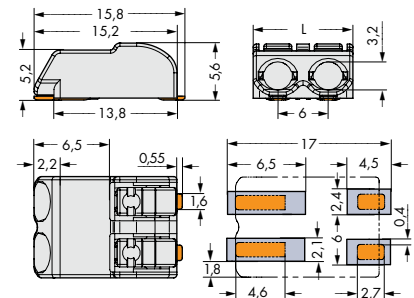

Pole No.	Item No.	Pack. Unit
<b>SMD terminal blocks with push-buttons in tape-and-reel packaging, white</b>		
Reel diameter: 330 mm		
1	2061-601/998-404	8100 (9 x 900)
2	2061-602/998-404	6300 (9 x 700)
3	2061-603/998-404	4050 (9 x 450)





[www.wago.com/SMD](http://www.wago.com/SMD)

WAGO Kontakttechnik GmbH & Co. KG  
Postfach 28 80 · D · 32385 Minden  
Hansastraße 27 · D · 32423 Minden  
Germany  
Phone: +49 571 887-0  
Fax: +49 571 887-169  
E-mail: [info@wago.com](mailto:info@wago.com)  
Online: [www.wago.com](http://www.wago.com)

