



HESTORE.HU

elektronikai alkatrész áruház

EN: This Datasheet is presented by the manufacturer.

Please visit our website for pricing and availability at www.hestore.hu.

DOGM GRAPHIC SERIES

6.2009

132x32 DOTS



EA DOGM132W-5 +
EA LED55x31-A

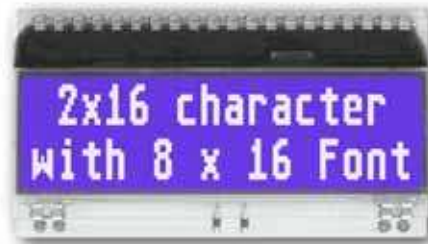

EA DOGM132B-5 +
EA LED55x31-W

**flexible display
content !**



EA DOGM132W-6 +
EA LED55x31-W

TECHNICAL DATA

- * HIGH-CONTRAST LCD SUPERTWIST DISPLAY (STN AND FSTN) WITH 15µm DOT GAP
- * OPTIONAL LED BACKLIGHTS IN VARIOUS COLORS
- * 132x32 PIXELS (CORRESPONDS TO 4x22 CHARACTERS OR 2x16 LARGE CHARACTERS)
- * ST 7565R CONTROLLER WITH SPI (4-WIRE) INTERFACE
- * POWER SUPPLY: SINGLE SUPPLY 2.4..3.3V (TYPICALLY 140µA)
- * NO ADDITIONAL VOLTAGES REQUIRED
- * OPERATING TEMPERATURE RANGE -20°C TO +70°C (STORAGE -30°C TO +80°C)
- * LED BACKLIGHTING 5..45mA
- * NO MOUNTING REQUIRED: SIMPLY SOLDER ONTO PCB

ORDERING CODE

GRAPHICS DISPLAY, 132x32, 55x31mm

x: *W* = white background (FSTN pos. transfective)

E = yellow/green background (STN pos. transmissive)

B = blue background (STN neg. transmissive)

S = black background (FSTN neg. transmissive)

L = yellow/green background (STN pos. reflective, cannot be backlit)

LED BACKLIGHT, WHITE

LED BACKLIGHT, YELLOW/GREEN

LED BACKLIGHT, BLUE

LED BACKLIGHT, RED

LED BACKLIGHT, AMBER

LED BACKLIGHT, FULL COLOR RGB

EA DOGM132X-5

EA LED55X31-W

EA LED55X31-G

EA LED55X31-B

EA LED55X31-R

EA LED55X31-A

EA LED55X31-RGB

ACCESSORIES

USB TEST BOARD FOR PC (WINDOWS)

SOCKET CONNECTOR 4.8 mm HEIGHT (2 PCS. REQUIRED)

DISK WITH 10 CHARACTER SETS e.g. 6x8, 8x8, 8x16, CYRILLIC

EA 9780-1USB

EA FL-20P

EA USBSTICK-FONT

**ELECTRONIC
ASSEMBLY**

making things easy

EA DOGM132

The EA DOGM132, a 132x32-pixel graphics display, is a new addition to ELECTRONIC ASSEMBLY's EA DOGM series. It, too, has pins that allow it to be mounted quickly and easily. 6 different optional LED backlights are available. These can be combined with 5 different display technologies, making it possible to have up to around 20 different designs. Designed for compact, handheld devices, this modern LCD series offers a number of benefits with and without backlighting:

- * Extremely compact (55x31 mm) with a large viewing area of 51x15 mm
- * Super-flat: 2.0 mm without backlight module, and only 5.8 mm with a b./l. module mounted
- * Serial SPI interface (4-wire)
- * Single supply +2.4 V or +3.3 V
- * Typical power consumption of only 140µA in full operation (white LED backlight from 5mA)
- * Easily mounted by soldering
- * Wide range of design variants orderable as single units
- * Backlighting color changes possible

CONTRAST ADJUSTMENT

The contrast can be set by means of a command for all the displays in the EA DOGM series. The contrast setting of the display must be set once by the software, and is then kept constant throughout the entire operating temperature range (-20..+70°C), thanks to the integrated temperature compensation.

LED BACKLIGHT

6 different variants are available for individual backlighting: white, yellow/green, blue, red, amber and a full-color version.

There are 2 separate LED paths available for each monochrome backlight that can be switched in parallel or in series to suit the system voltage. This means that most backlights can be run at either 3.3 V or 5 V.

To operate the backlight, we recommend a current source (e.g. CAT4238TD) or an external series resistor to limit the current. This can be calculated from $R=U/I$; you can find the values in the table on the right. To prolong the life of the backlights, we recommend that you use a current source.

The operating life of the yellow/green, red and amber backlights is 100,000 hours. The life of the white and blue backlights is considerably shorter. We recommend that you dim these or switch them off whenever possible.

Important: Never connect the backlight LEDs directly to a 5 V / 3.3 V supply as this will immediately destroy the LEDs. Always use a current source. Please note that derating applies at temperatures exceeding +25°C.

ASSEMBLING

First, clip the display and backlight modules together by gently pushing the display pins through the corresponding holes on the backlight module. Then insert the entire module into the socket, or into the soldering holes on the pcb. The backlight pins (the 2 rows with 3 pins at the bottom) must be soldered on the top side as well to ensure good contact between the modules.

Important: The display has a protective film on the top and/or the bottom, and there is also one on the backlight. These must be removed.

Make sure that neither display nor backlight will never come into contact with any kind of liquid like Fluxer, Cleaner, Water.

yellow/green EA LED55x31-G	Forwar voltage	Current max.	Limiting resistor	
			@ 3,3 V	@ 5 V
Connected in parallel	2,2 V	80 mA	14 ohm	35 ohm
Connected in series	4,4 V	40 mA	-	15 ohm

white EA LED55x31-W	Forwar voltage	Current max.	Limiting resistor	
			@ 3,3 V	@ 5 V
Connected in parallel	3,2 V	60 mA	1,6 ohm	30 ohm
Connected in series	6,4 V	30 mA	-	-

blue EA LED55x31-B	Forwar voltage	Current max.	Limiting resistor	
			@ 3,3 V	@ 5 V
Connected in parallel	3,2 V	60 mA	1,6 ohm	30 ohm
Connected in series	6,4 V	30 mA	-	-





amber EA LED55x31-A	Forwar voltage	Current max.	Limiting resistor	
			@ 3,3 V	@ 5 V
Connected in parallel	2,4 V	80 mA	11 ohm	32 ohm
Connected in series	4,8 V	40 mA	-	5 ohm

red EA LED55x31-R	Forwar voltage	Current max.	Limiting resistor	
			@ 3,3 V	@ 5 V
Connected in parallel	2,1 V	80 mA	15 ohm	36 ohm
Connected in series	4,2 V	40 mA	-	20 ohm

Full color EA LED55x31-RGB	Forwar voltage	Current max.	Limiting resistor	
			@ 3,3 V	@ 5 V
Connected in parallel	4 V	125 mA	-	3x24 ohm

5 DIFFERENT TECHNOLOGIES

See below for an overview of available technologies, combinations with available backlights and their usability:

Display	Technology	Optional backlight	Readability	Display color non backlighted	Display color with backlight	Required backlight
	EA DOGM132W FSTN pos. transflective	usage is possible with and without backlight module	even without backlight readable	black on white	black on backlight color	white, blue, amber, RGB
	EA DOGM132E STN pos. yellow/green transmissive	backlight module is necessary	even without backlight readable	dark green on yellow/green	black on yellow/green	yellow/green
	EA DOGM132B STN neg. blue transmissive	backlight module is necessary	---	---	backlight color on blue-black background	white, yellow/green
	EA DOGM132S FSTN neg. transmissive	backlight module is necessary	---	---	backlight color on black background	white, amber, RGB
	EA DOGM132L STN pos. yellow/green reflective	no backlight possible	good at "normal" ambient brightness	dark green on yellow/green	---	---

6 AND MORE DIFFERENT BACKLIGHTS

6 and more different backlight colors are available to match equipments design as much as possible. The most effective and brightest one is the white one EA LED55x31-W.

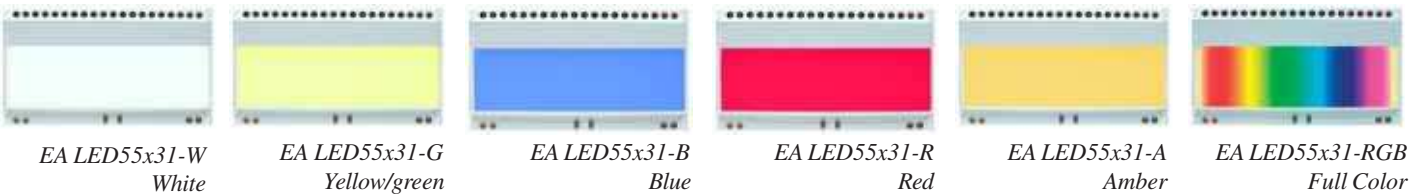

If you see black and white pictures on this page but you want to see the colors of the displays, you can download a full-colored version of this document at

<http://www.lcd-module.de/eng/pdf/grafik/dogm132-5e.pdf>

APPLICATION EXAMPLES

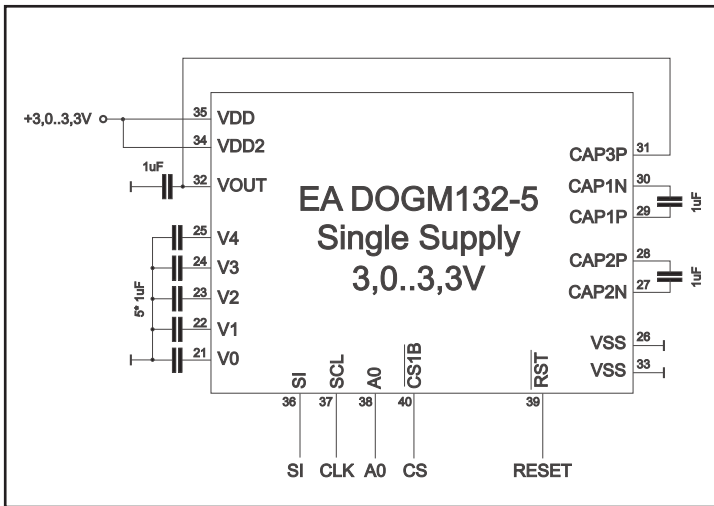

LOW POWER

+3.0V or +3.3V (single supply) operation requires 8 external capacitors. Current consumption typ. 110uA

WIDE RANGE

The operation on +2.4..+3.3V (single supply) requires 9 external capacitors. Current consumption is typ. 150uA.

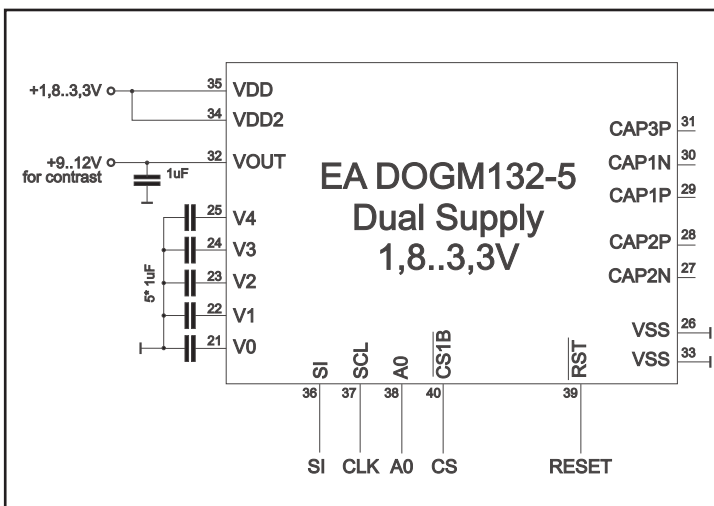
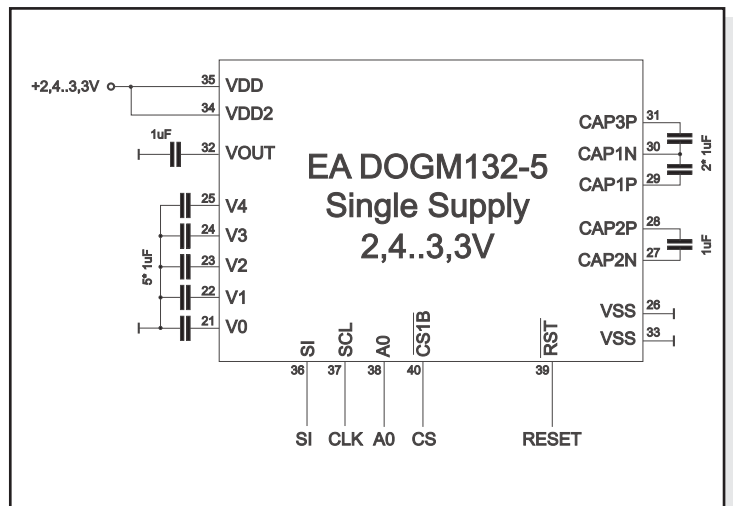

LOW VOLTAGE

If an external source of +9..+12V (does not have to be stabilized) is available, the charge pump is not needed and less external components are required. Supply and logic voltage may be 1.8..3.3V

TABLE OF PROGRAMMING COMMANDS

Command	Command Code									Function		
	A0	D7	D6	D5	D4	D3	D2	D1	D0			
(1) Display ON/OFF	0	1	0	1	0	1	1	1	0	0	LCD display ON/OFF 0: OFF, 1: ON	
(2) Display start line set	0	0	1	Display start address								Sets the display RAM display start line address
(3) Page address set	0	1	0	1	1	Page address					Sets the display RAM page address	
(4) Column address set upper bit	0	0	0	0	1	Most significant column address					Sets the most significant 4 bits of the display RAM column address.	
Column address set lower bit		0	0	0	0	Least significant column address					Sets the least significant 4 bits of the display RAM column address.	
(6) Display data write	1	Write data									Writes to the display RAM	
(8) ADC select	0	1	0	1	0	0	0	0	0	0	Sets the display RAM address SEG output correspondence 0: normal, 1: reverse	
(9) Display normal/reverse	0	1	0	1	0	0	1	1	0	1	Sets the LCD display normal/ reverse 0: normal, 1: reverse	
(10) Display all points ON/OFF	0	1	0	1	0	0	1	0	0	0	Display all points 0: normal display 1: all points ON	
(11) LCD bias set	0	1	0	1	0	0	0	1	0	1	Sets the LCD drive voltage bias ratio 0: 1/9 bias, 1: 1/7 bias (ST7565R)	
(14) Reset	0	1	1	1	0	0	0	1	0		Internal reset	
(15) Common output mode select	0	1	1	0	0	0	*	*	*	*	Select COM output scan direction 0: normal direction 1: reverse direction	
(16) Power control set	0	0	0	1	0	1	Operating mode				Select internal power supply operating mode	
(17) V ₀ voltage regulator internal resistor ratio set	0	0	0	1	0	0	Resistor ratio				Select internal resistor ratio(Rb/Ra) mode	
(18) Electronic volume mode set	0	1	0	0	0	0	0	0	0	1	Set the V ₀ output voltage electronic volume register	
Electronic volume register set		0	0	Electronic volume value								
(19) Static indicator ON/OFF	0	1	0	1	0	1	1	0	0	0	0: OFF, 1: ON	
Static indicator register set		0	0	0	0	0	0	0	0	0	Mode	Set the flashing mode
(20) Booster ratio set	0	1	1	1	1	1	0	0	0	0	select booster ratio 00: 2x,3x,4x 01: 5x 11: 6x	
(21) Power save	0										Display OFF and display all points ON compound command	
(22) NOP	0	1	1	1	0	0	0	1	1		Command for non-operation	

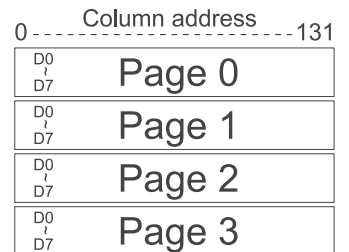

DATA TRANSFER

Data transfer is unidirectional. That means that data can only be written; it cannot be read again. In contrast to other displays, a busy query is not necessary with this display. The clock-pulse rate of the SCL line can be up to 20 MHz @3.3V, depending on the supply voltage. You will find more detailed information on timing on pages 64 and 65 of the data sheet of the ST7565R controller, which you will find on our website at <http://www.lcd-module.de/eng/pdf/zubehoer/st7565r.pdf>

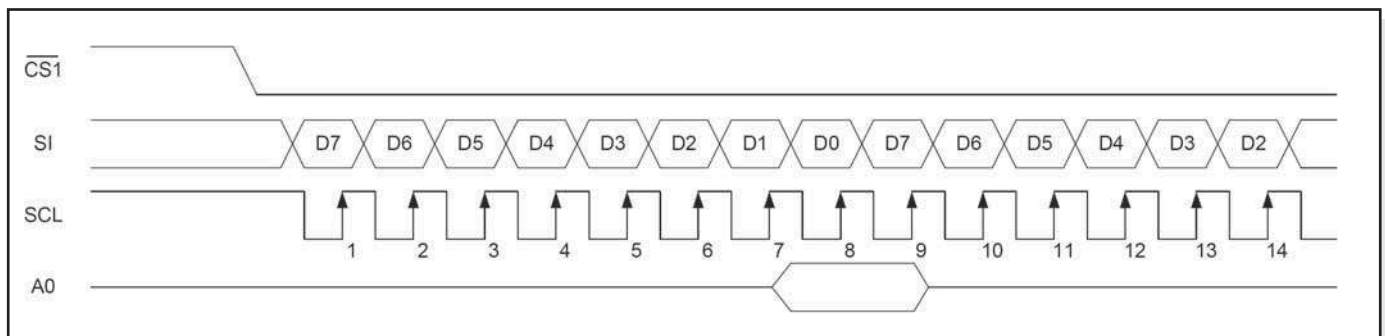

INITIALISATION EXAMPLE

Using the internal voltage converter (single supply +2.4V ..+3.3V).

Applications „LOW POWER“ and „WIDE RANGE“

Initialisation example for single supply (bottom view)											
Command	A0	D7	D6	D5	D4	D3	D2	D1	D0	Hex	Remark
(2) Display start line set	0	0	1	0	0	0	0	0	0	\$40	Display start line 0
(8) ADC set	0	1	0	1	0	0	0	0	1	\$A1	ADC reverse *)
(15) Common output mode select	0	1	1	0	0	0	0	0	0	\$C0	Normal COM0~COM31
(9) Display normal/reverse	0	1	0	1	0	0	1	1	0	\$A6	Display normal
(11) LCD bias set	0	1	0	1	0	0	0	1	0	\$A2	Set bias 1/9 (Duty 1/33)
(16) Power control set	0	0	0	1	0	1	1	1	1	\$2F	Booster, Regulator and Follower on
(20) Booster ratio set	0	1	1	1	1	1	0	0	0	\$F8	Set internal Booster to 3x / 4x
		0	0	0	0	0	0	0	0	\$00	
(17) V0 voltage regulator set	0	0	0	1	0	0	0	1	1	\$23	Contrast set
(18) Electronic volume mode set	0	1	0	0	0	0	0	0	1	\$81	
		0	0	0	1	1	1	1	1	\$1F	
(19) Static indicator set	0	1	0	1	0	1	1	0	0	\$AC	No indicator
		0	0	0	0	0	0	0	0	\$00	
(1) Display ON/OFF	0	1	0	1	0	1	1	1	1	\$AF	Display on

*) Make sure that for 6:00 viewing direction ADC has to be set to „reverse“ (mirrored layout) !



Orientation for 6 o'clock (Bottom View)

INITIALISATION EXAMPLE

Using an external power supply for contrast (dual power supply).

Application „LOW VOLTAGE“

Initialisation example for dual power supply (bottom view)											
Command	A0	D7	D6	D5	D4	D3	D2	D1	D0	Hex	Remark
(2) Display start line set	0	0	1	0	0	0	0	0	0	\$40	Display start line 0
(8) ADC set	0	1	0	1	0	0	0	0	1	\$A1	ADC reverse *)
(15) Common output mode select	0	1	1	0	0	0	0	0	0	\$C0	Normal COM0~COM31
(9) Display normal/reverse	0	1	0	1	0	0	1	1	0	\$A6	Display normal
(11) LCD bias set	0	1	0	1	0	0	0	1	0	\$A2	Set bias 1/9 (Duty 1/33)
(16) Power control set	0	0	0	1	0	1	0	1	1	\$2B	Booster off, Regulator, Follower on
(17) V0 voltage regulator set	0	0	0	1	0	0	0	1	1	\$23	Contrast set
(18) Electronic volume mode set	0	1	0	0	0	0	0	0	1	\$81	
		0	0	0	1	1	1	1	1	\$1F	
(19) Static indicator set	0	1	0	1	0	1	1	0	0	\$AC	No indicator
		0	0	0	0	0	0	0	0	\$00	
(1) Display ON/OFF	0	1	0	1	0	1	1	1	1	\$AF	Display on

*) Make sure that for 6:00 viewing direction ADC has to be set to „reverse“ (mirrored layout) !

12:00 VIEWING ANGLE, TOP VIEW OPTION

If the display is read mostly from above (on the front of a laboratory power supply unit, for example), the preferred angle of viewing can be set to 12 o'clock. This rotates the display by 180°. A slightly different initialization setup is required for this. Also keep in mind that the leftmost column (normally numbered as 0) will now change to 4.



Orientation for 12 o'clock (Top View)

Initialisation example top view											
Command	A0	D7	D6	D5	D4	D3	D2	D1	D0	Hex	Remark
(8) ADC set	0	1	0	1	0	0	0	0	0	\$A0	ADC normal
(15) Common output mode select	0	1	1	0	0	1	0	0	0	\$C8	Reverse COM31-COM0

USB-TEST BOARD EA 9780-1USB

For easy startup, a USB test board is available that can be connected to a PC. A USB cable and Windows software is supplied with the product. This allows text and images (BMP) to be displayed directly on the connected display. You will find more information on the test board in the EA 9780-1USB data sheet.

SIMULATION WITH WINDOWS

A simulator window also displays the contents of the display. The software can simulate all the displays and colors even without the hardware. You can download the software free from our website: <http://www.lcd-module.de/deu/disk/startdog.zip>



DIMENSIONS EA DOGM132

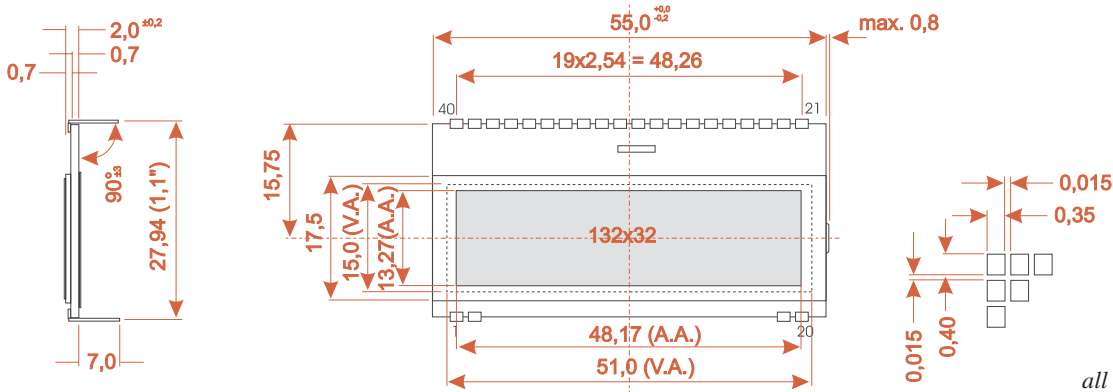

all dimensions are in mm



Pin	Symbol	Level	Function	Pin	Symbol	Level	Function
1	NC		(A1+: LED backlight)	21	V0	-	LC Drive
2	NC		(C1-: LED backlight)	22	V1	-	LC Drive
3				23	V2	-	LC Drive
4				24	V3	-	LC Drive
5				25	V4	-	LC Drive
6				26	VSS	L	Power Supply 0V (GND)
7				27	CAP2N	-	Voltage Converter
8				28	CAP2P	-	Voltage Converter
9				29	CAP1P	-	Voltage Converter
10				30	CAP1N	-	Voltage Converter
11				31	CAP3P	-	Voltage Converter
12				32	VOUT	-	Voltage Output +9..12V
13				33	VSS	L	Power Supply 0V (GND)
14				34	VDD2	H	Power Supply Booster
15				35	VDD	H	Power Supply +1.8..3.3V
16				36	SI	H/L	Serial Data In
17				37	SCL	H/L	Serial Clock
18				38	A0	H/L	L= Command, H= Data
19	NC		(C2-: LED backlight)	39	RST	L	Reset (active low)
20	NC		(A2+: LED backlight)	40	CS1B	L	Chip Select (active low)

Note:

- LC displays are generally not suited for wave or reflow soldering. Temperatures of over 80°C can cause lasting damage.
- The surfaces of the displays and backlights are protected from scratching by self-adhesive protective foils. Please remove these before mounting.
- Make sure that either display nor backlight will never come into contact with any kind of liquid like Fluxer, Cleaner, Water.



DIMENSIONS EA LED55X31

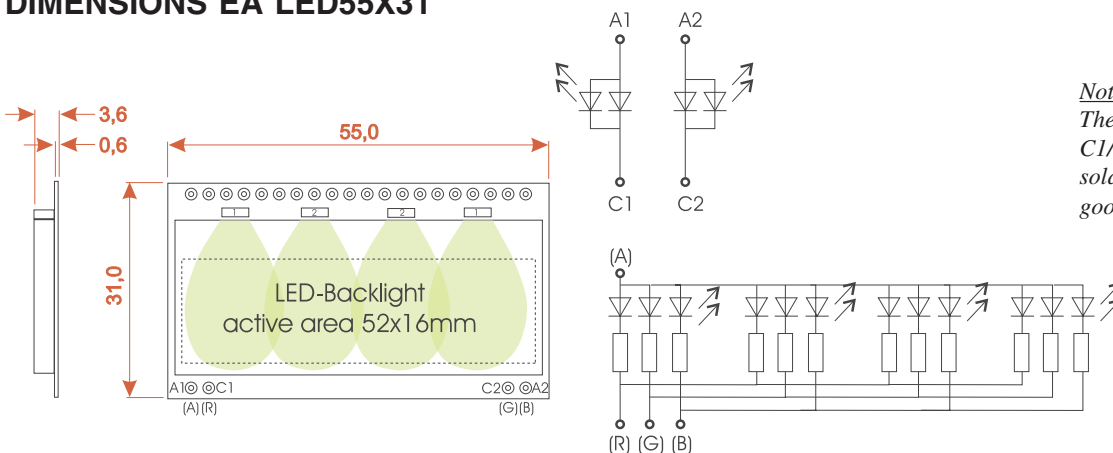

Note:

The 4 LED pins A1/A2 and C1/C2 also have to be soldered from above to ensure good contact.

all dimensions are in mm

ELECTRONIC ASSEMBLY

making things easy