



HESTORE.HU

elektronikai alkatrész áruház

EN: This Datasheet is presented by the manufacturer.

Please visit our website for pricing and availability at www.hestore.hu.



1.5A LED Driver with Internal Switch

Product Description

SCT2932 is a high efficiency, constant current, continuous mode inductive step-down converter, designed for driving constant current to high power (single or multiple) LED with only 4 external components. SCT2932 operates from input supply between 5V and 33V and provides an externally adjustable output current of up to 1.5A.

The SCT2932 is specifically designed with PFM control to enhance the efficiency up to 97%. The Output current can be modify by an external resister, and can adjusted, by applying an external control signal to the DIM pin, The DIM pin will accept a PWM waveform.

Additionally, to ensure the system reliability, SCT2932 is built-in with over temperature protection, and LED open-circuit short-circuit protection to protect system from being damaged.

Features

- ◆ 1.5A output current
- ◆ Wide input voltage range: 5V to 33V
- ◆ High efficiency (up to 97%)
- ◆ Internal NDMOS power switch
- ◆ Single pin on/off and brightness control using PWM
- ◆ Hysteretic PFM improves efficiency at light loads
- ◆ With thermal/soft start /LED open-short detect protection
- ◆ Only 4 external components
- ◆ Up to 1Mhz switching frequency
- ◆ Typical 3% output current accuracy

Applications

- ◆ High power LED lighting
- ◆ Automotive LED lighting
- ◆ Low voltage industrial lighting
- ◆ LED backlighting
- ◆ Constant current source

Pin Configuration/Package Type

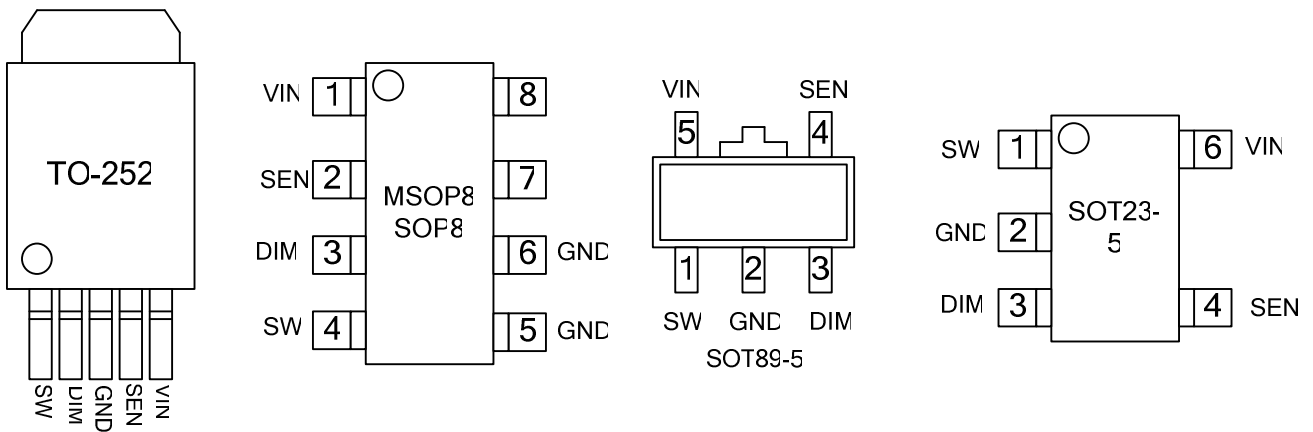

Terminal Description

Pin Name	I/O	Function
SW	O	Drain of NDMOS switch
GND	-	Ground terminal
DIM	I	Dimming control terminal
SEN	I	Connect resistor RS from this pin to VIN to define nominal average output current
VIN	-	Power supply terminal

Ordering Information

Part	Marking	Package	Unit per reel(pcs)
SCT2932C	SCT2932C	Green TO252-5	80-Tube
SCT2932D	SCT2932D	Green MSOP8 (with thermal pad)	80-Tube
SCT2932E	SCT2932E	Green SOP8 (with thermal pad)	100-Tube
SCT2932F	2932F	Green SOT89-5	1000
SCT2932J	932J	Green SOT23-5	3000

StarChips Technology, Inc.

4F, No.5, Technology Rd., Science-Based Industrial Park, Hsin-Chu, Taiwan, R.O.C.

Tel : +886-3-577-5767 Ext.555,

Fax: +886-3-577-6575,

E-mail : service@starchips.com.tw

Maximum Ratings ($T_A = 25^\circ\text{C}$)

Characteristic		Symbol	Rating	Unit
Supply voltage		V_{IN}	0-33 (40V for 0.5 sec)	V
Output current		I_{OUT}	1.875	A
Sustaining voltage at SW pin		V_{SW}	-0.5~33 (40V for 0.5 sec)	V
Power dissipation ¹	SOP8TP	P_D	1.4	W
	MSOP8TP		1.45	
	TO252		2.8	
	SOT23-6		1.2	
	SOT23-5		1.2	
	SOT89-5		1.45	
Thermal resistance	SOP8TP	$R_{TH(j-a)}$	89.3	$^\circ\text{C/W}$
	MSOP8TP		86.2	
	TO252		44.6	
	SOT23-6		104.2	
	SOT23-5		104.2	
	SOT89-5		86.2	
Operating junction temperature		$T_{J(max)}$	150	$^\circ\text{C}$
Operating temperature		T_{OPR}	-40 to +85	$^\circ\text{C}$
Storage temperature		T_{STG}	-55 to +150	$^\circ\text{C}$

The absolute maximum ratings are a set of ratings not to be exceeded. Stresses beyond those listed under "Maximum Ratings" may cause the device breakdown, deterioration even permanent damage. Exposure to the maximum rating conditions for extended periods may affect device reliability.

1. The PCB size is 22mm*20mm (2 layers), power dissipation depends on PCB layout.

Electrical Characteristics(V_{IN}=12V, V_{OUT}=3.6V, L₁=68uH, C_{IN}=C_{OUT}=10uF, T_A= 25 °C; unless otherwise specified.)

Characteristic	Symbol	Conditions	Min.	Typ.	Max.	Unit
Operating voltage	V _{IN}	-	5	-	33	V
Operating current	I _{IN}	V _{IN} =5V~33V	-	1	2	mA
Power down current	I _{OFF}	V _{IN} =5V~33V	-	50	-	uA
Output current	I _{OUT}	-	-	-	1.5	A
Output current Accuracy	ΔI _{OUT} /I _{OUT}	150mA ≤ I _{OUT} ≤ 1A	-	±3	±5	%
Efficiency	-	V _{IN} =12V, I _{OUT} =350mA, V _{OUT} =10.8V	-	97	-	%
SW Dropout voltage	ΔV _{sw}	I _{OUT} =1A	-	0.5	-	V
Internal propagation delay	T _{PD}	-	100	200	300	nS
Input voltage	V _{IH}	-	3.5	-	5	V
	V _{IL}	-	0	-	0.5	V
Sense threshold hysteresis	V _{SENSEHYS}	-	-	±15	-	%
Mean current sense threshold voltage	V _{SENSE}	-	95	100	105	mV
Switch on resistance	R _{DS(ON)}	V _{IN} =12V, I _{OUT} =350mA, V _{OUT} =10.8V	-	0.33	-	Ω
Minimum switch 'ON' time	T _{ONmin}	-	100	350	450	nS
Minimum switch 'OFF' time	T _{OFFmin}	-	100	350	450	nS
Recommended duty cycle range of switch	D _{sw}	-	0.2	-	0.8	-
maximum operating frequency	Freq _{MAX}	-	40	-	1000	KHz
Thermal Shutdown Threshold	T _{SD}	-	145	160	175	°C
Thermal Shutdown Hysteresis	T _{SD-HYS}	-	-	20	-	°C
Duty cycle range of PWM signal applied to DIM pin	Duty _{DIM}	PWM frequency = 1KHz	0.01	-	1	-
Rise Time of Output current	T _r	V _{OUT} =3.6V, I _{OUT} =350mA, f _{DIM} =1kHz, Duty _{DIM} =50%	-	20	-	ns
Fall Time of Output current	T _f	V _{OUT} =3.6V, I _{OUT} =350mA, f _{DIM} =1kHz, Duty _{DIM} =50%	-	20	-	ns

Device Description ($T_A=25^\circ\text{C}$ unless otherwise noted)

The device, in conjunction with the coil (L1) and current sense resistor (RS), forms a self-oscillating continuous-mode buck converter.

Device Operation (Refer to block diagram and Figure 1 - Operating waveforms)

Operation can be best understood by assuming that the DIM pin of the device is unconnected and the voltage on this pin (VDIM) appears directly at the (+) input of the comparator. When input voltage VIN is first applied, the initial current in L1 and RS is zero and there is no output from the current sense circuit. Under this condition, the (-) input to the comparator is at ground and its output is high. This turns MN on and switches the SW pin low, causing current to flow from VIN to ground, via RS, L1 and the LED(s). The current rises at a rate determined by VIN and L1 to produce a voltage ramp (VSENSE) across RS. The supply referred voltage VSENSE is forced across internal resistor R1 by the current sense circuit and produces a proportional current in internal resistors R2 and R3. This produces a ground referred rising voltage at the (-) input of the comparator. When this reaches the threshold voltage (Vref), the comparator output switches low and MN turns off. The comparator output also drives another NMOS switch, which bypasses internal resistor R3 to provide a controlled amount of hysteresis. The hysteresis is set by R3 to be nominally 15% of VDIM.

When MN is off, the current in L1 continues to flow via D1 and the LED(s) back to VIN. The current decays at a rate determined by the LED(s) and diode forward voltages to produce a falling voltage at the input of the comparator. When this voltage returns to VDIM, the comparator output switches high again. This cycle of events repeat with the comparator input ramping between limits of $V_{ref} \pm 15\%$.

Switching Thresholds

With $V_{DIM} = V_{REF}$, the ratios of R1, R2 and R3 define an average V_{SENSE} switching threshold of 100mV (measured on the ISENSE pin with respect to V_{IN}). The average output current I_{OUTnom} is then defined by this voltage and R_S according to: $I_{OUTnom} = 100mV/R_S$ Nominal ripple current is $\pm 15mV/R_S$

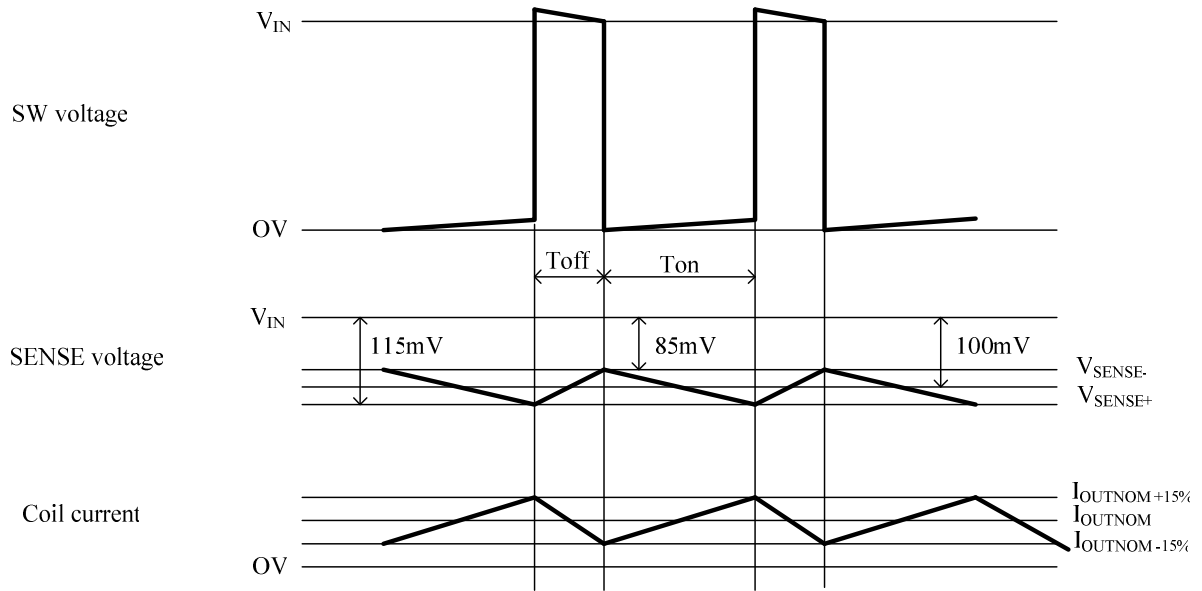
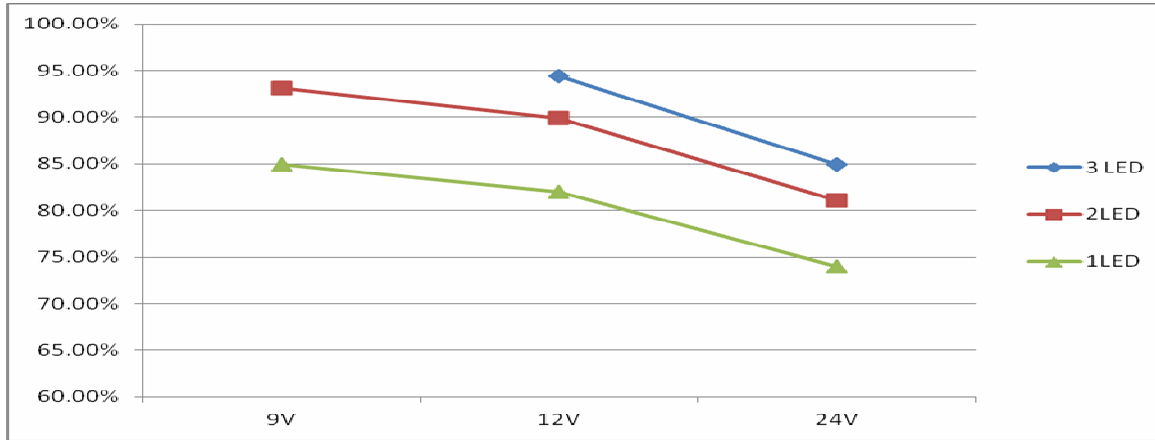

Figure 1-Operating waveforms

Typical Performance Characteristics

Efficiency vs. Input Voltage at Various LED Cascaded Number



Efficiency vs. input voltage @L=22uH, I_{OUT}=384mA

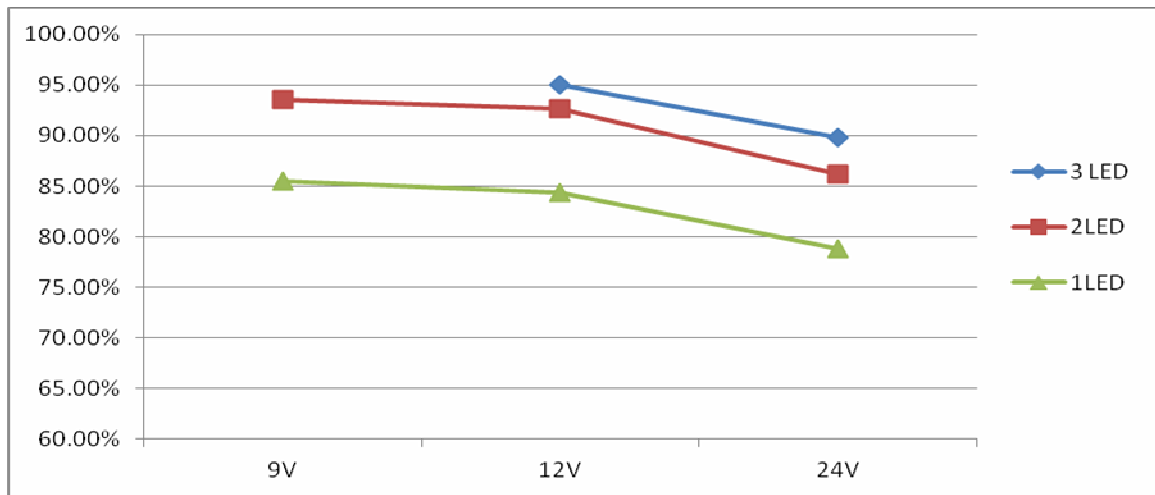

Efficiency vs. input voltage @L=68uH, I_{OUT}=384mA

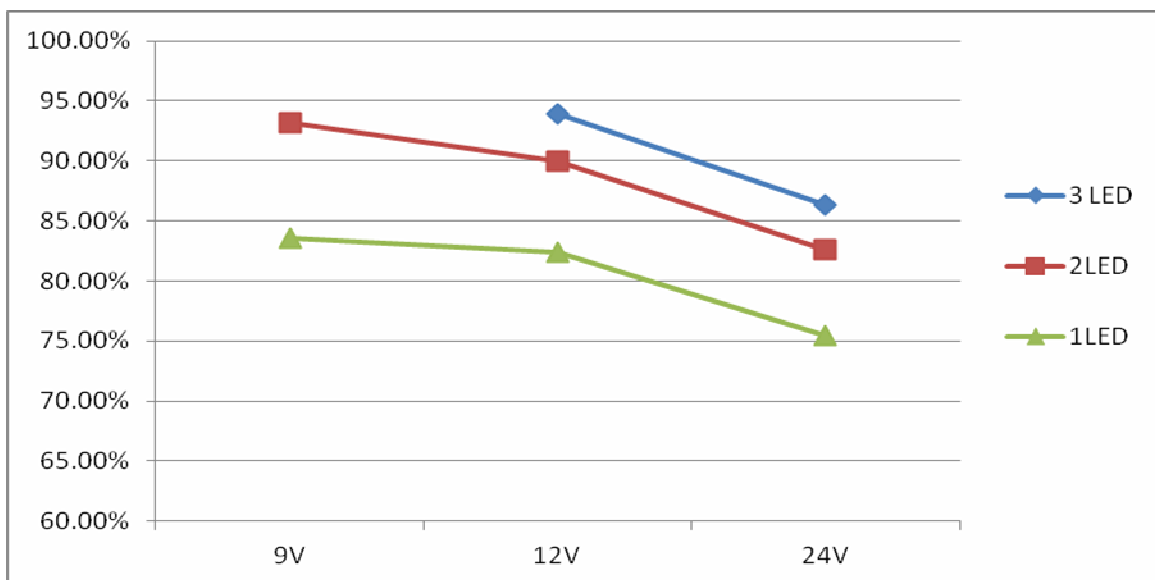

Efficiency vs. input voltage @L=22uH, I_{OUT}=769mA

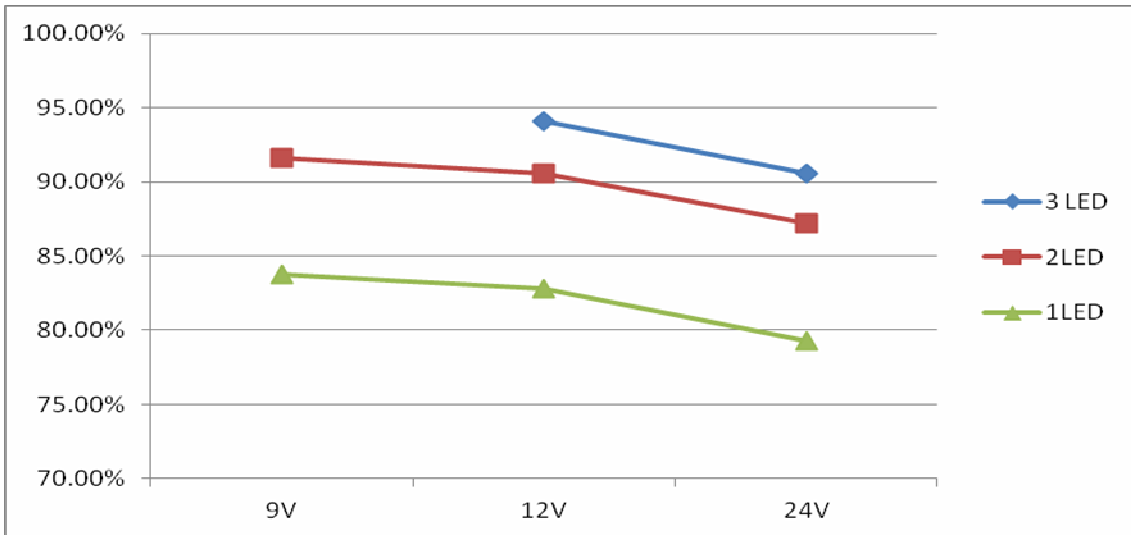

Efficiency vs. input voltage @L=68uH, I_{OUT}=769mA

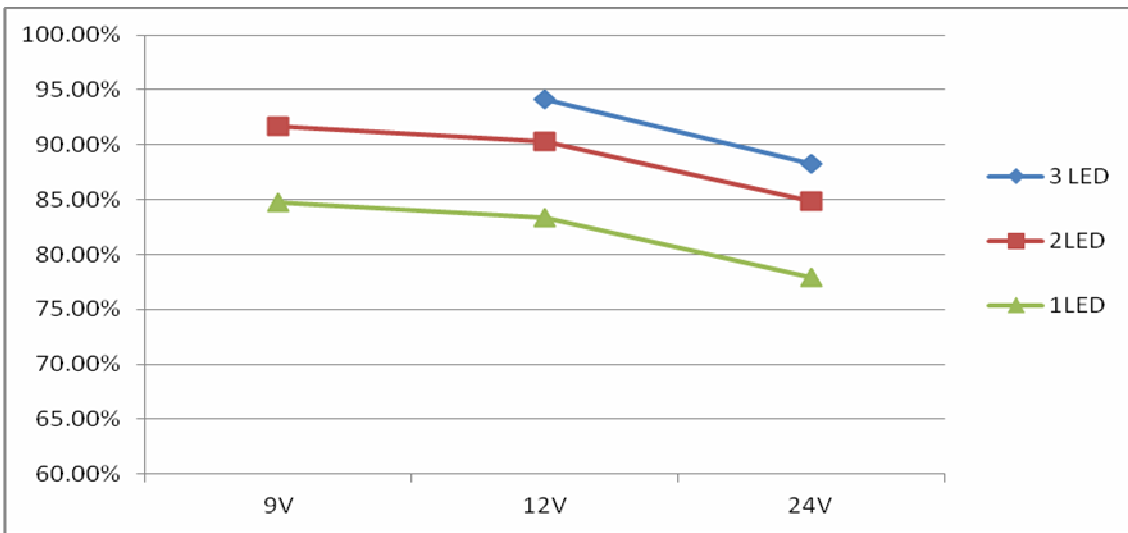

Efficiency vs. input voltage @L=22uH, I_{OUT}=1000mA

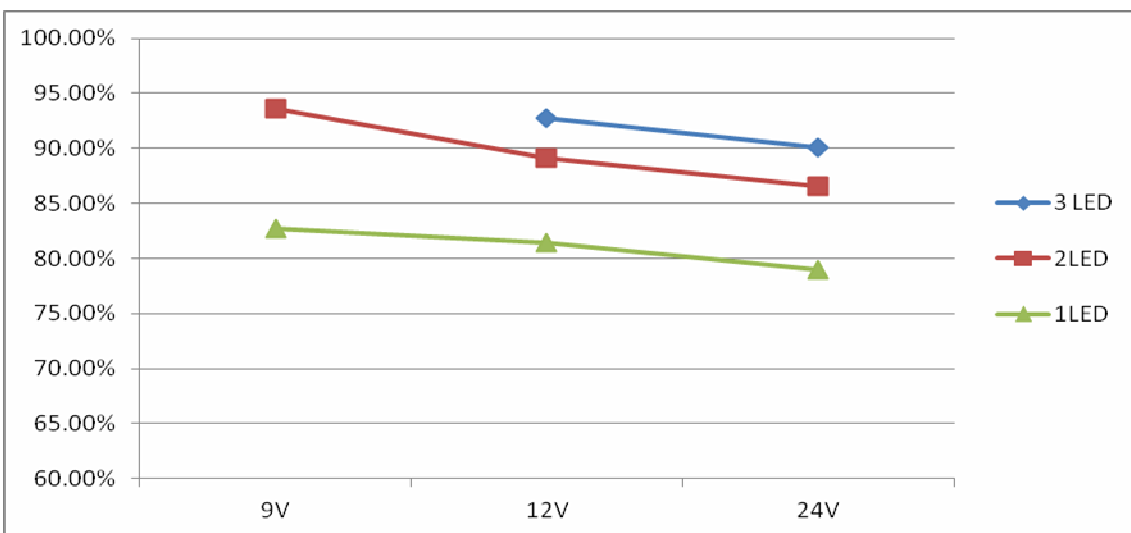

Efficiency vs. input voltage @L=68uH, I_{OUT}=1000mA

Efficiency vs. LED Cascaded Number at Various Input Voltage

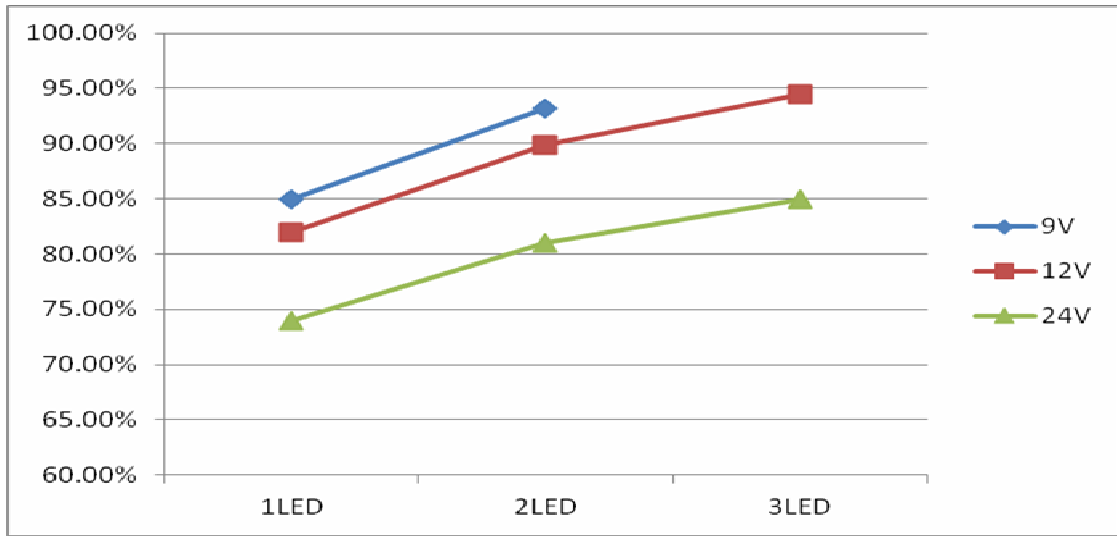

Efficiency vs. LED cascaded number @L=22uH, I_{OUT}=384mA

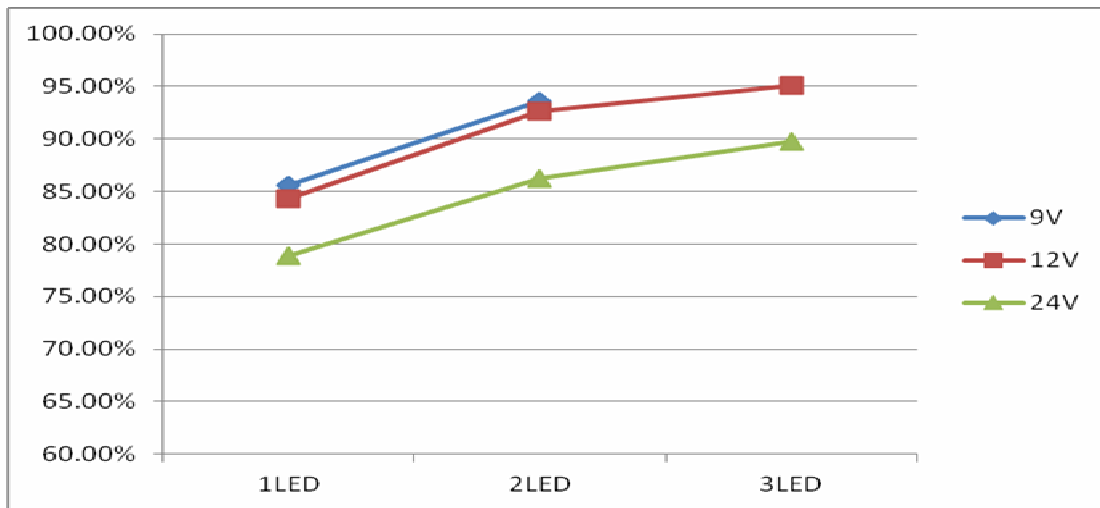

Efficiency vs. LED cascaded number @L=68uH, I_{OUT}=384mA

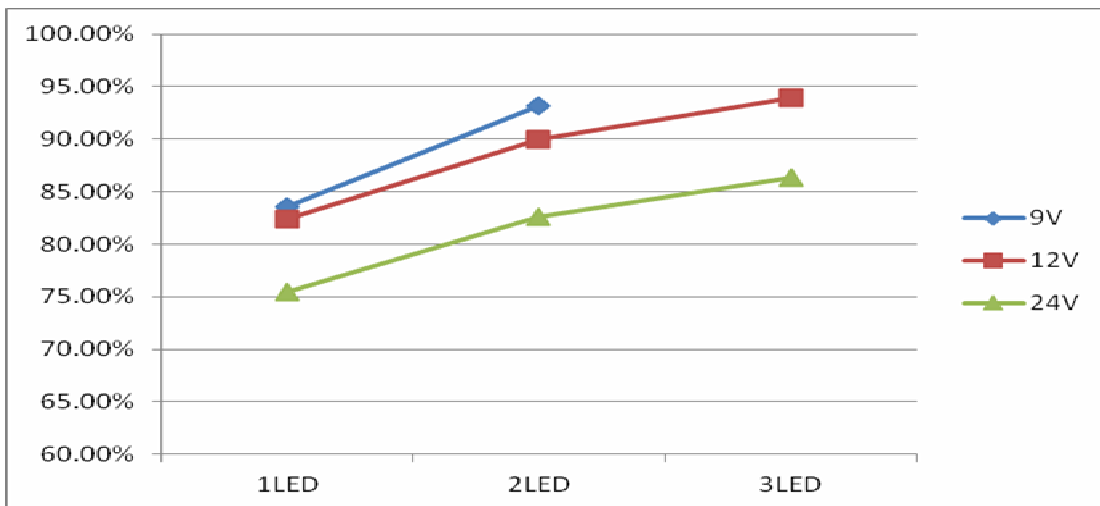

Efficiency vs. LED cascaded number @L=22uH, I_{OUT}=769mA

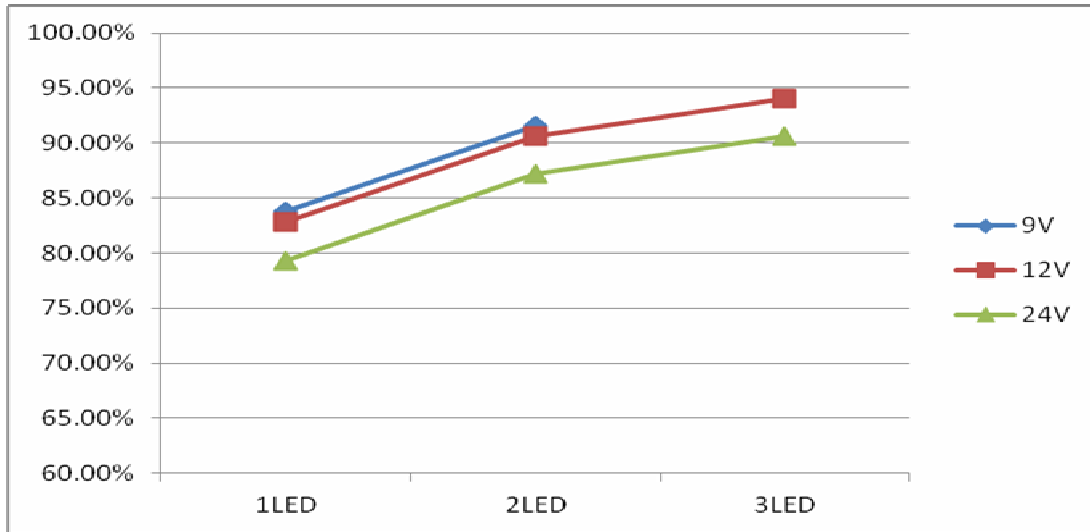

Efficiency vs. LED cascaded number @L=68uH, I_{OUT}=769mA

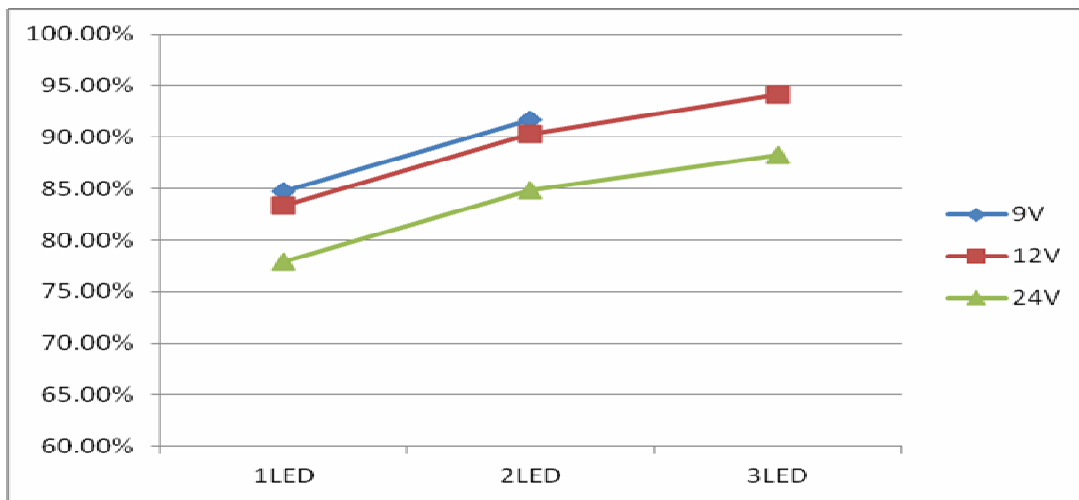

Efficiency vs. LED cascaded number @L=22uH, I_{OUT}=1000mA

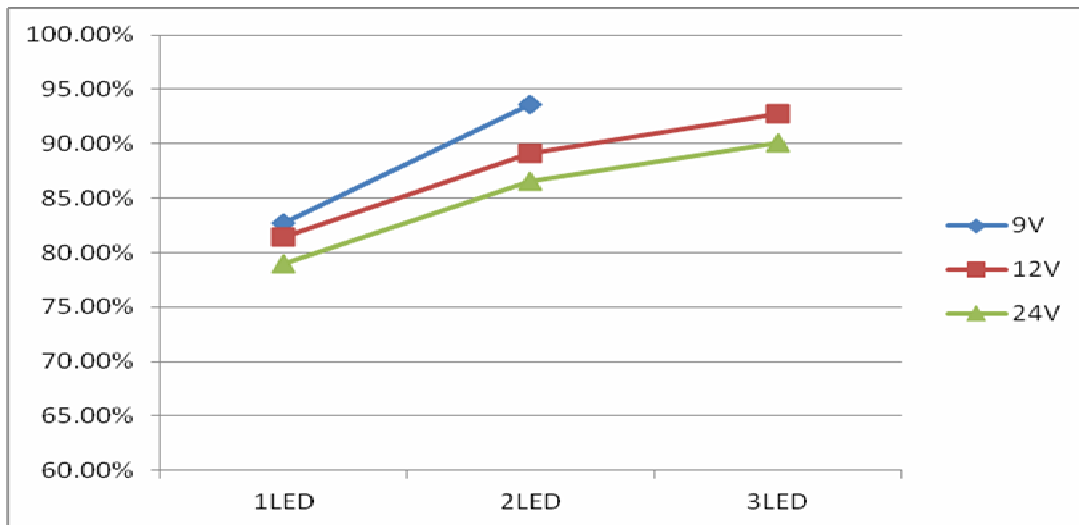

Efficiency vs. LED cascaded number @L=68uH, I_{OUT}=1000mA

Output Current vs. Input Voltage at Various LED Cascaded Number

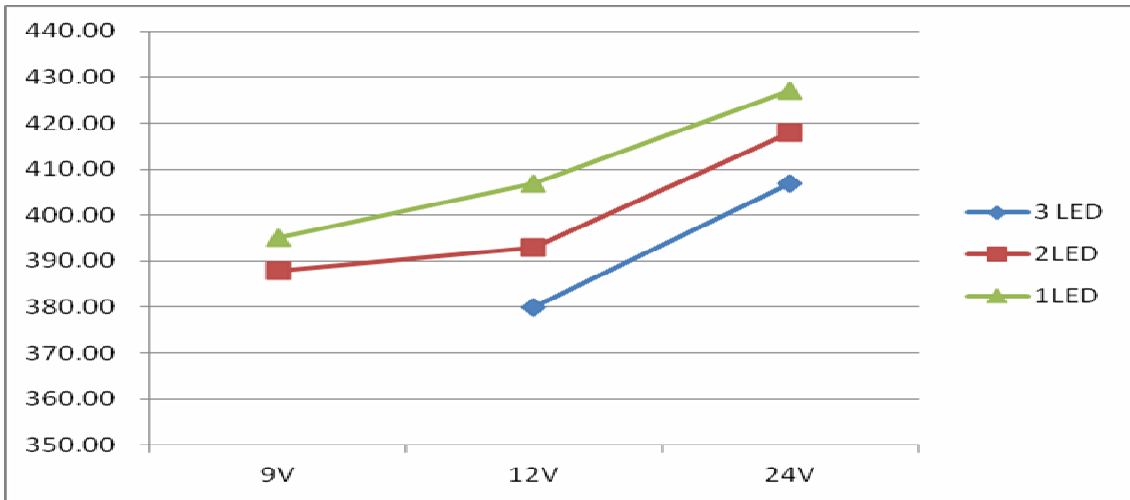

Output current vs. input voltage @L=22uH, I_{OUT}=384mA

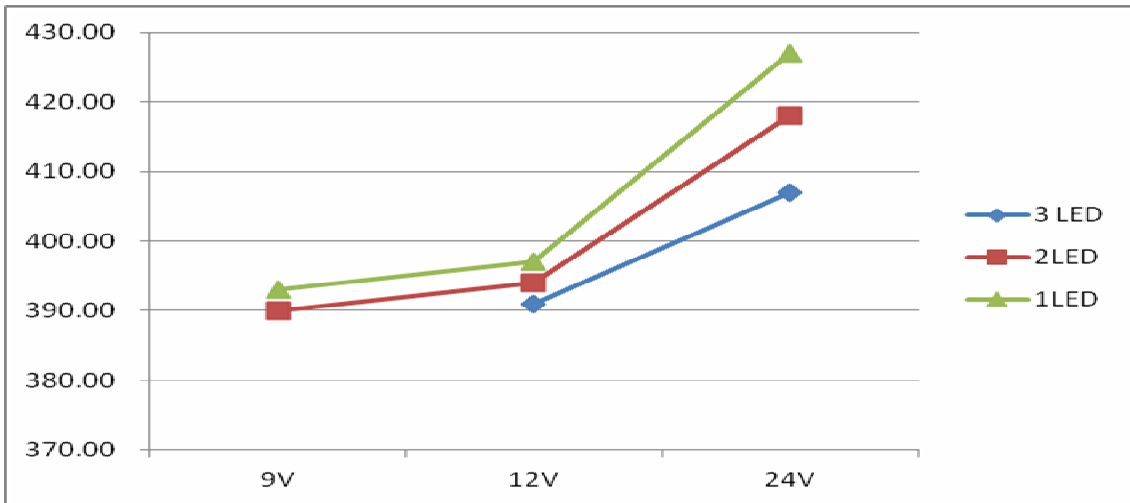

Output current vs. input voltage @L=68uH, I_{OUT}=384mA

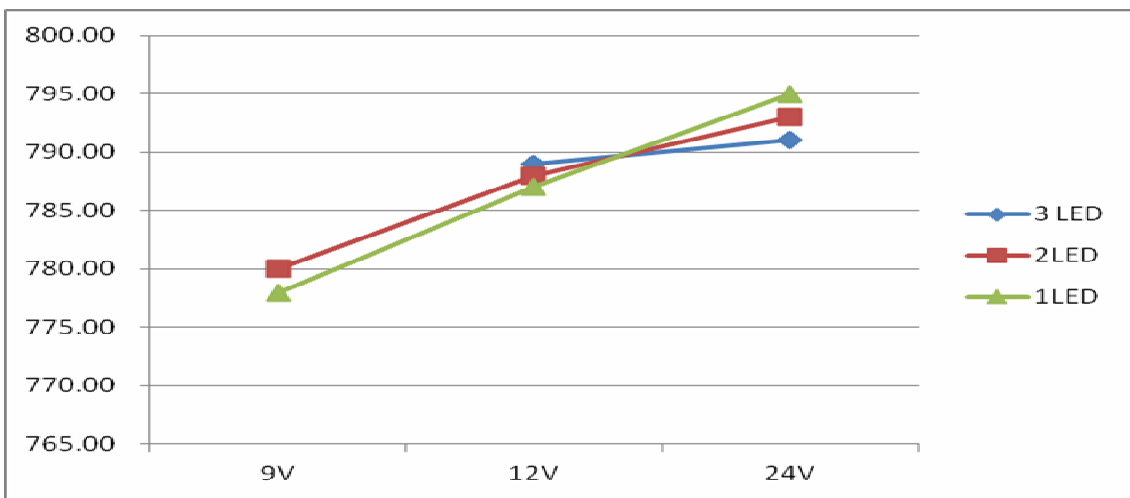

Output current vs. input voltage @L=22uH, I_{OUT}=769mA

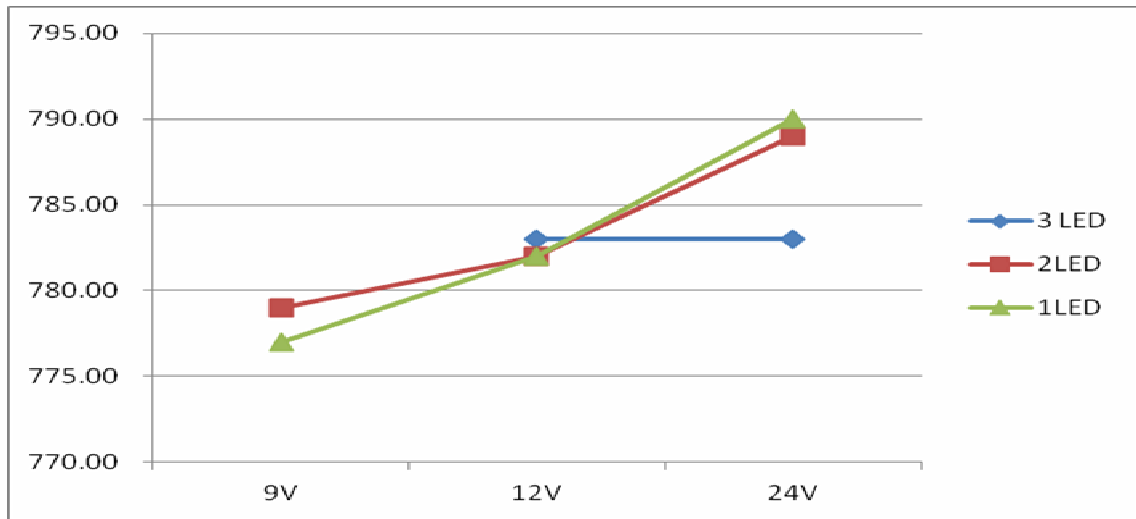

Output current vs. input voltage @L=68uH, I_{OUT}=769mA

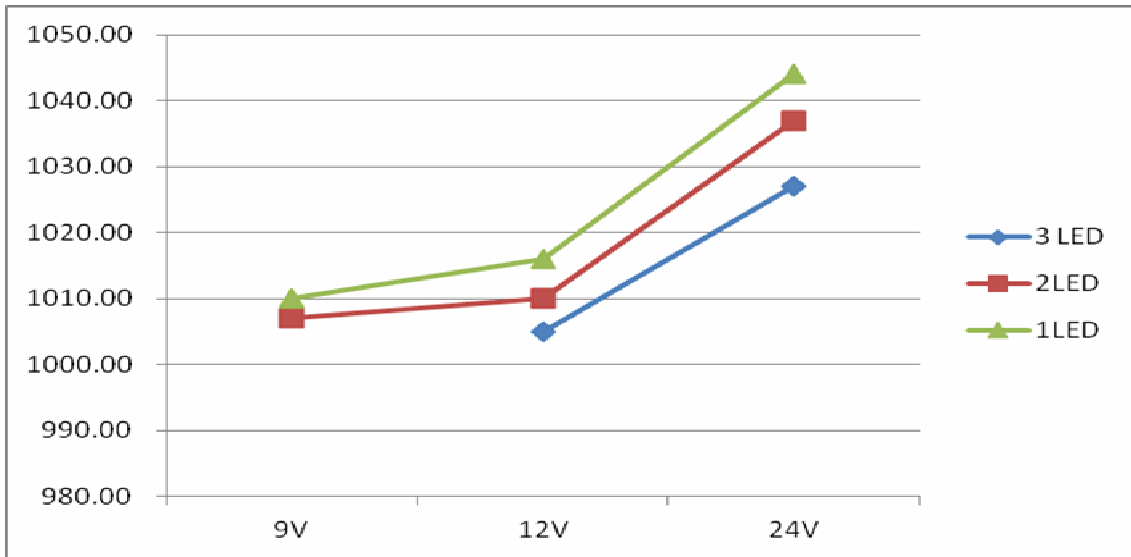

Output current vs. input voltage @L=22uH, I_{OUT}=1000mA

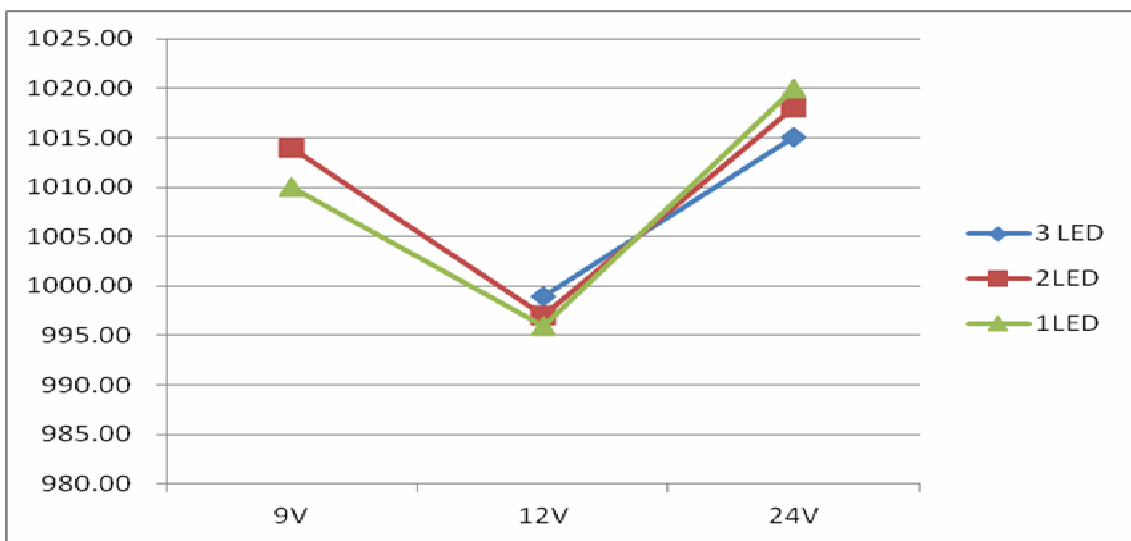

Output current vs. input voltage @L=68uH, I_{OUT}=1000mA

Output Current vs. Input Voltage at Various Inductor

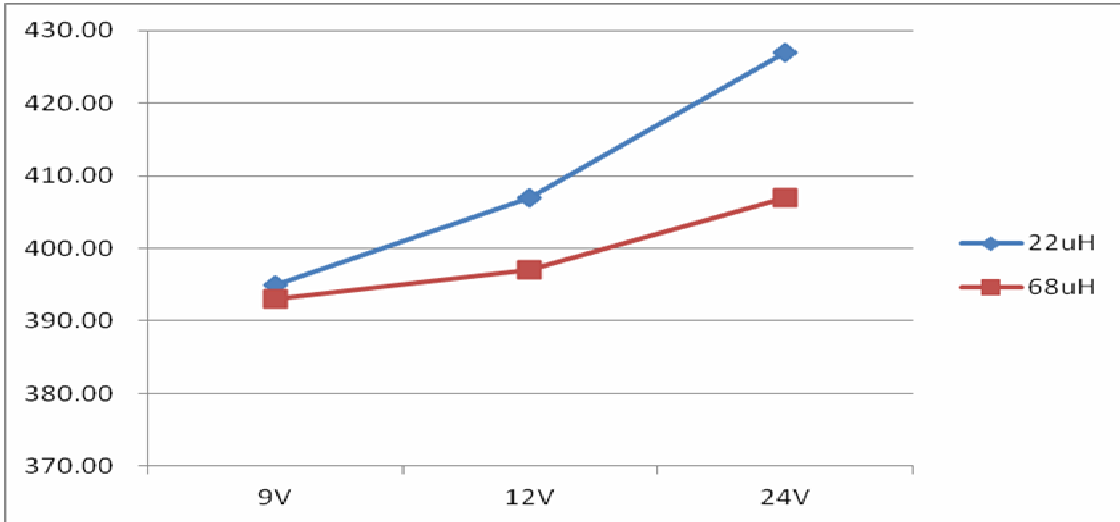

Output current vs. input voltage @1-LED in cascaded, $I_{OUT}=384mA$

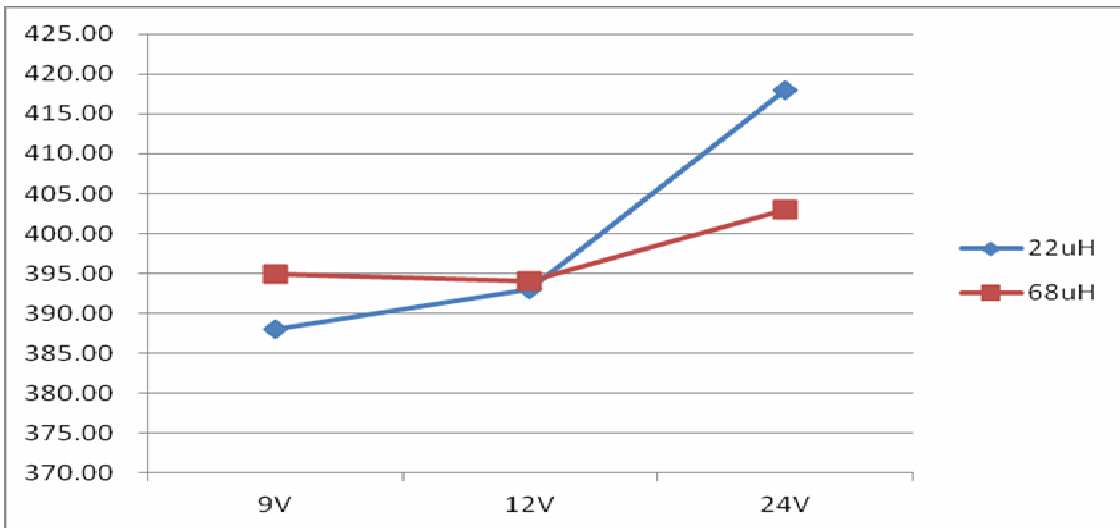

Output current vs. input voltage @2-LED in cascaded, $I_{OUT}=384mA$

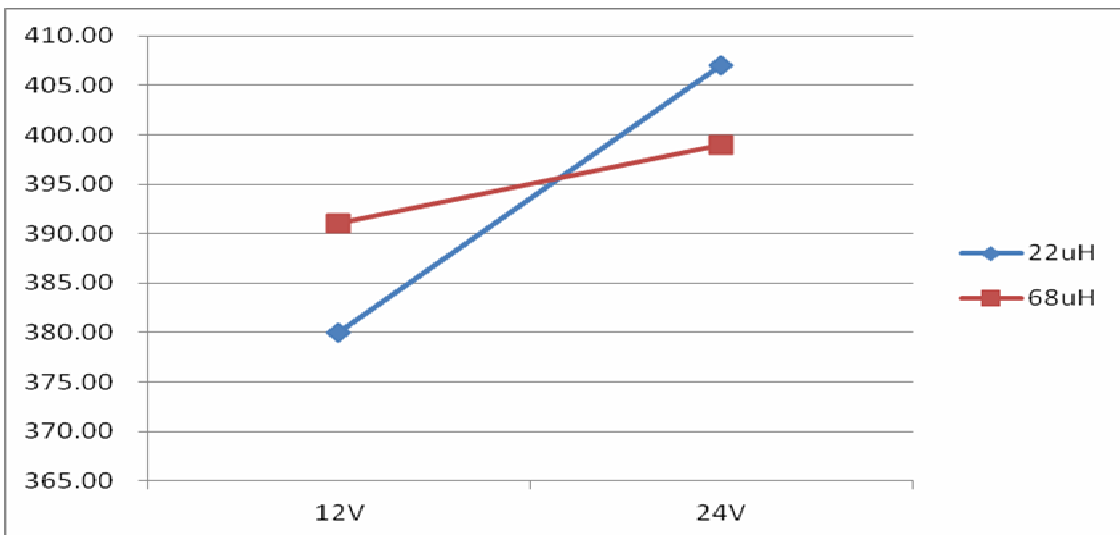

Output current vs. input voltage @3-LED in cascaded, $I_{OUT}=384mA$

Output Current vs. LED Cascaded Number at Various Input Voltage

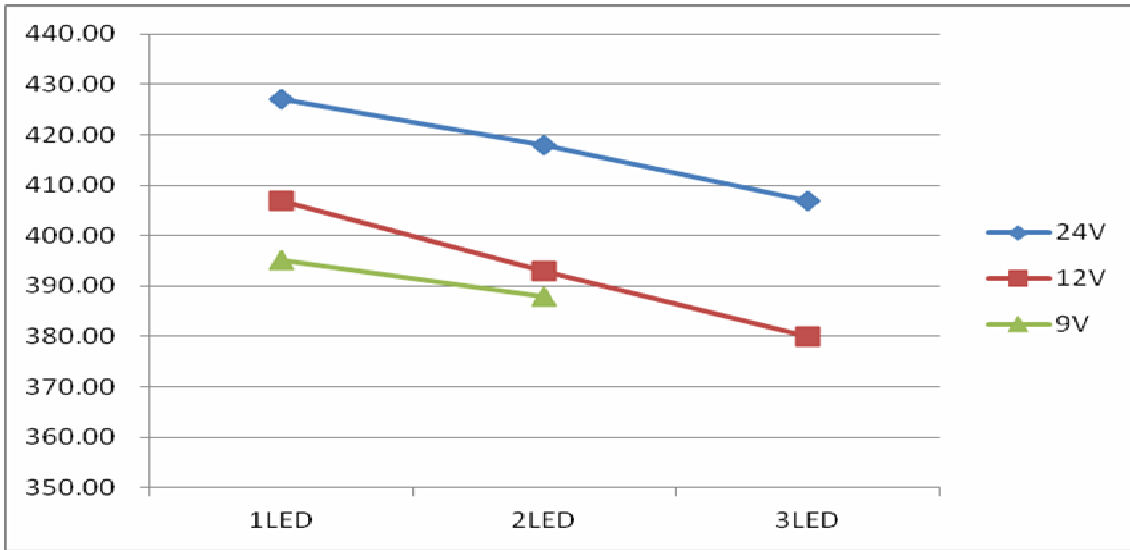

Output current vs. LED cascaded number @L=22uH, I_{OUT}=384mA

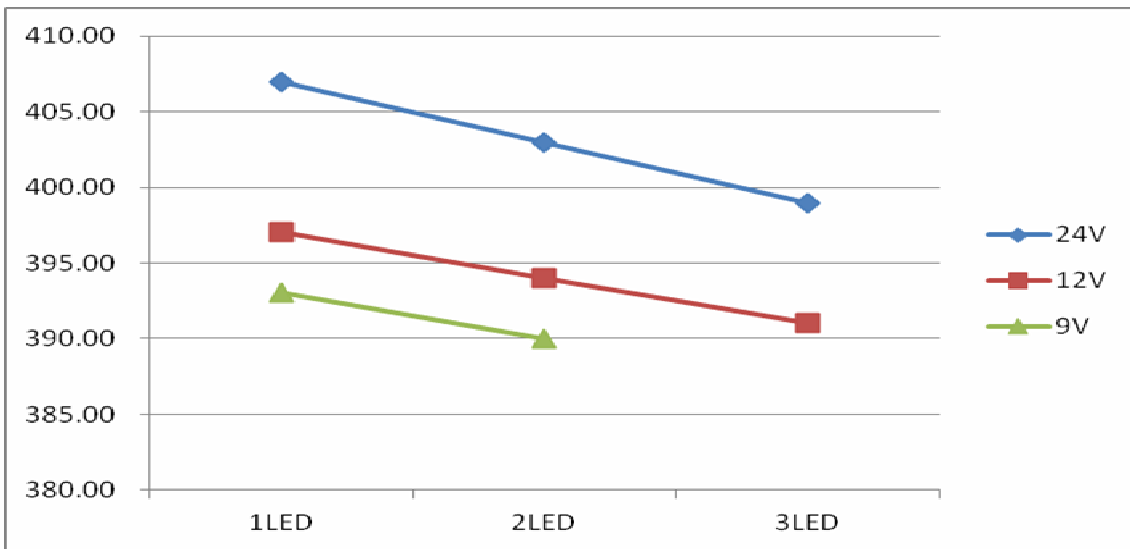

Output current vs. LED cascaded number @L=68uH, I_{OUT}=384mA

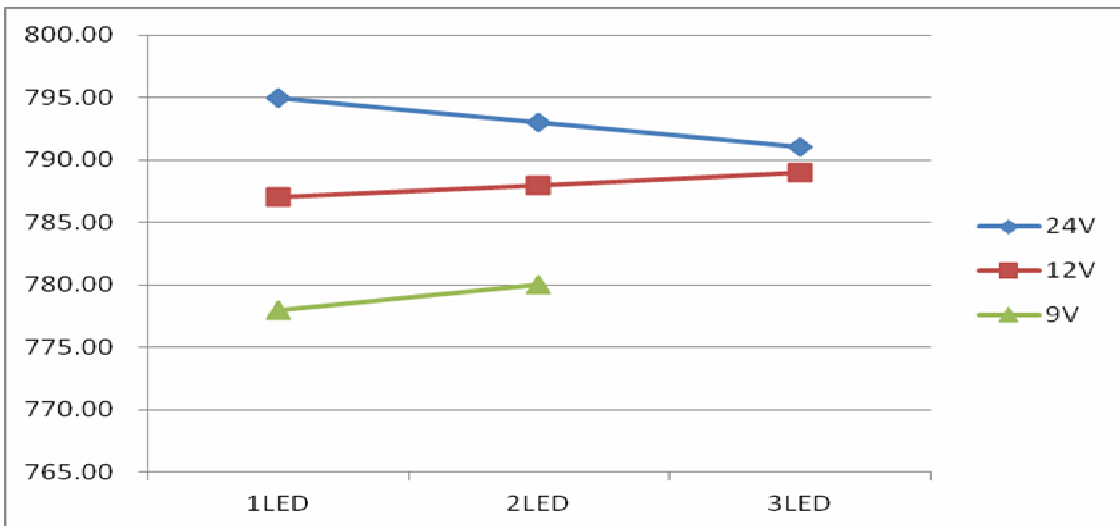

Output current vs. LED cascaded number @L=22uH, I_{OUT}=769mA

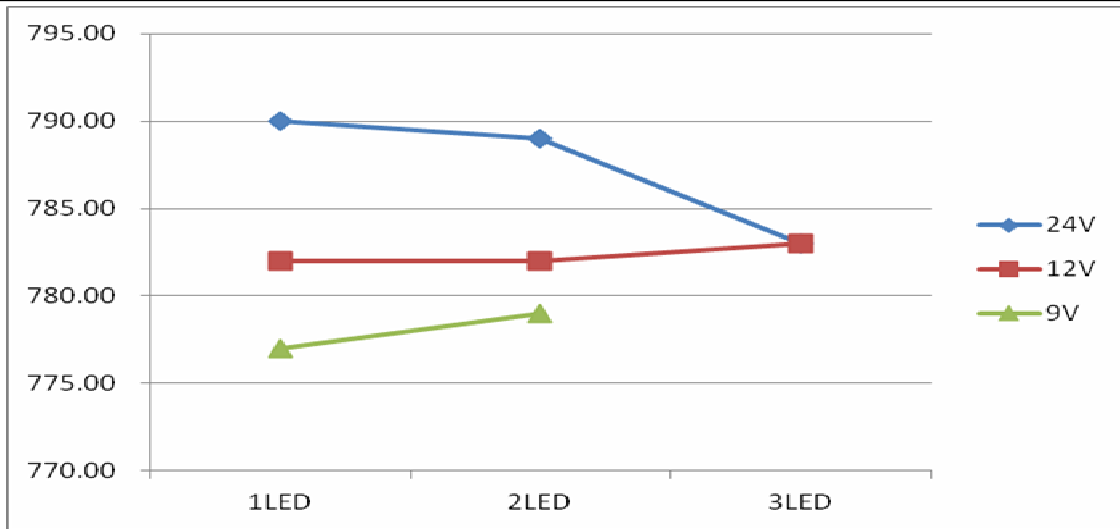

Output current vs. LED cascaded number @L=68uH, I_{OUT}=769mA

Output Current vs. LED Cascaded number at Various Inductor

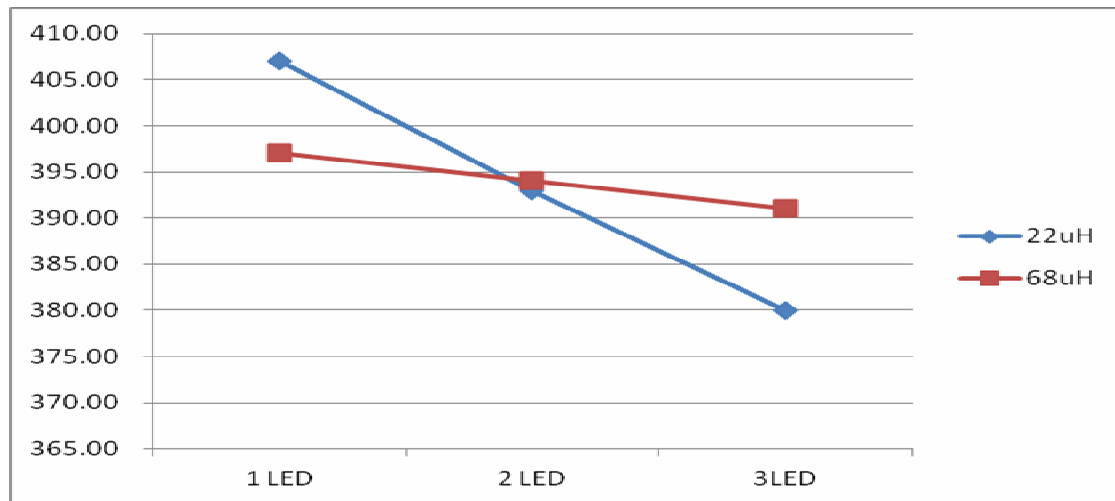

Output Current vs. LED Cascaded number @V_{IN}=12V, I_{OUT}=384mA

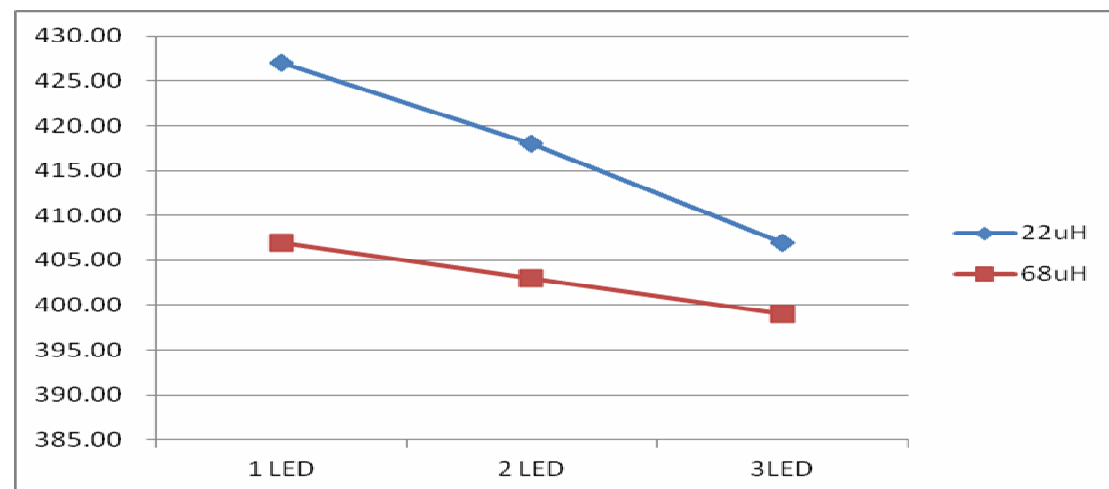

Output Current vs. LED Cascaded number @V_{IN}=24V, I_{OUT}=384mA

Switching Frequency vs. LED Cascaded Number at Various Inductor

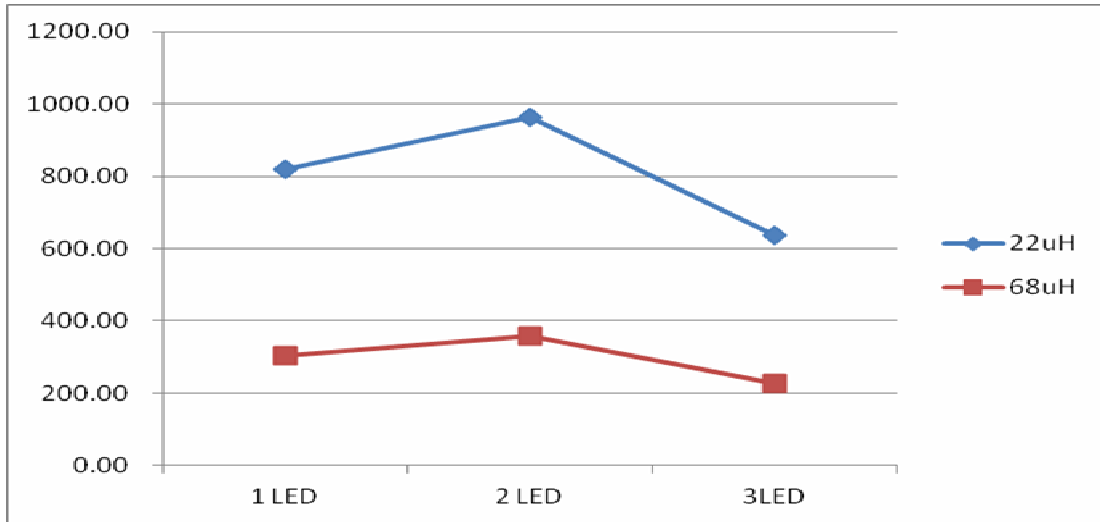

Switching Frequency vs. LED Cascaded Number @VIN=12V, IOUT=384mA

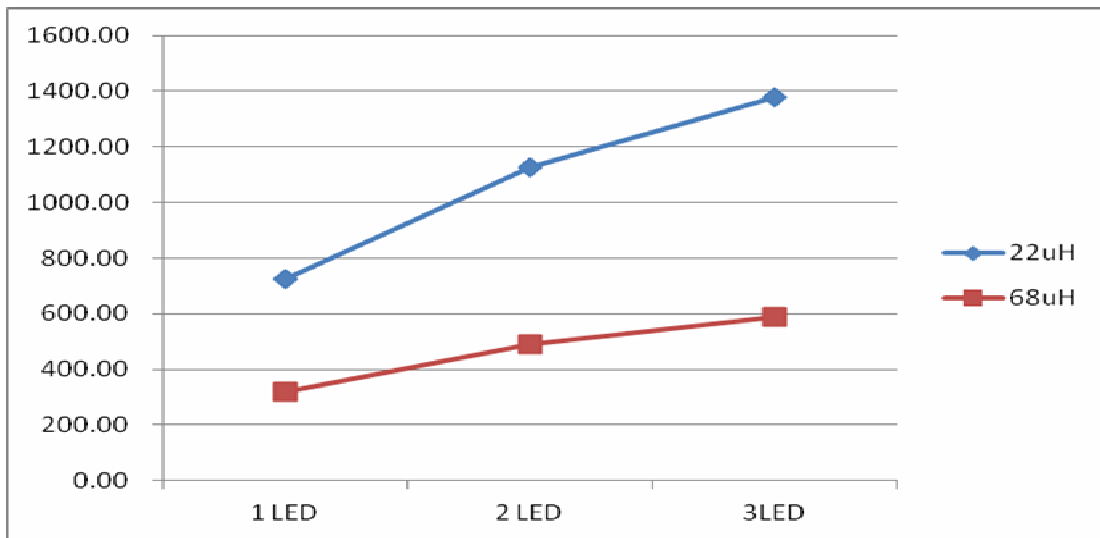

Switching Frequency vs. LED Cascaded Number @VIN=24V, IOUT=384mA

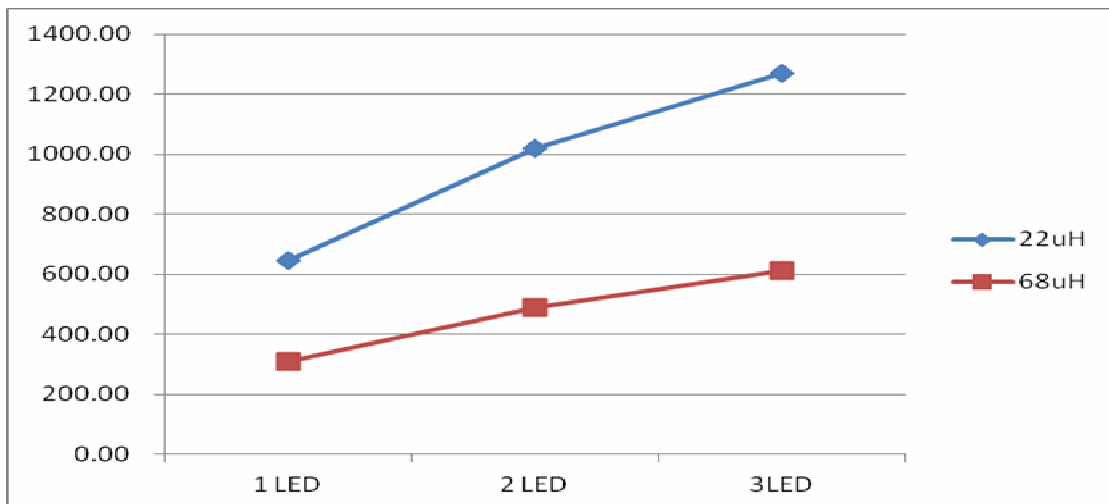

Switching Frequency vs. LED Cascaded Number @VIN=30V, IOUT=384mA

Dimming and switching waveforms

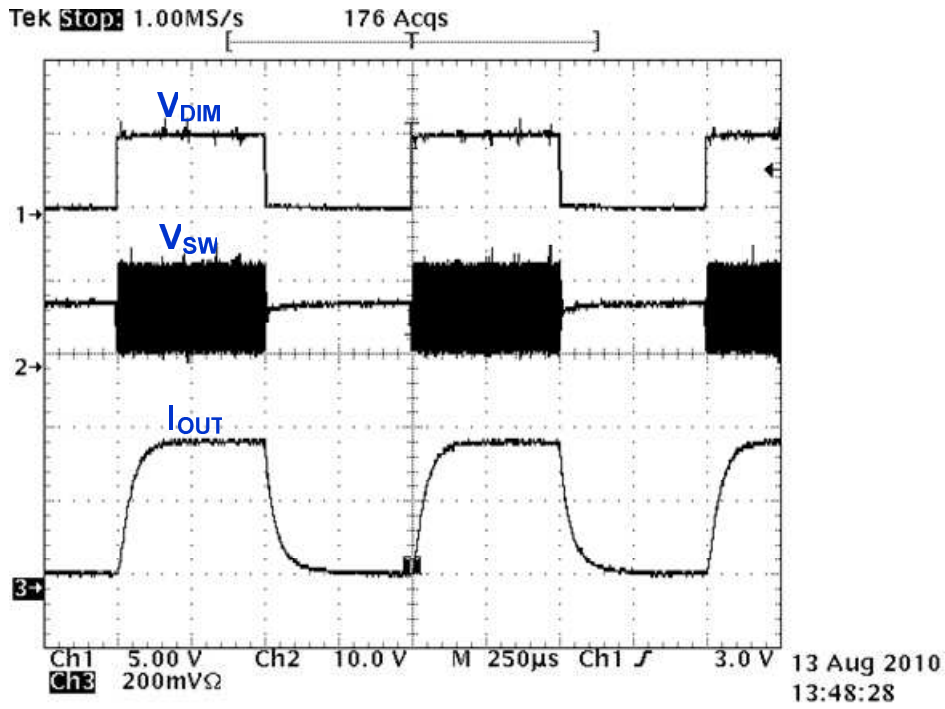

Dimming waveform ($V_{IN}=12V$, $R_{SEN}=0.27\Omega$, 3-LED)

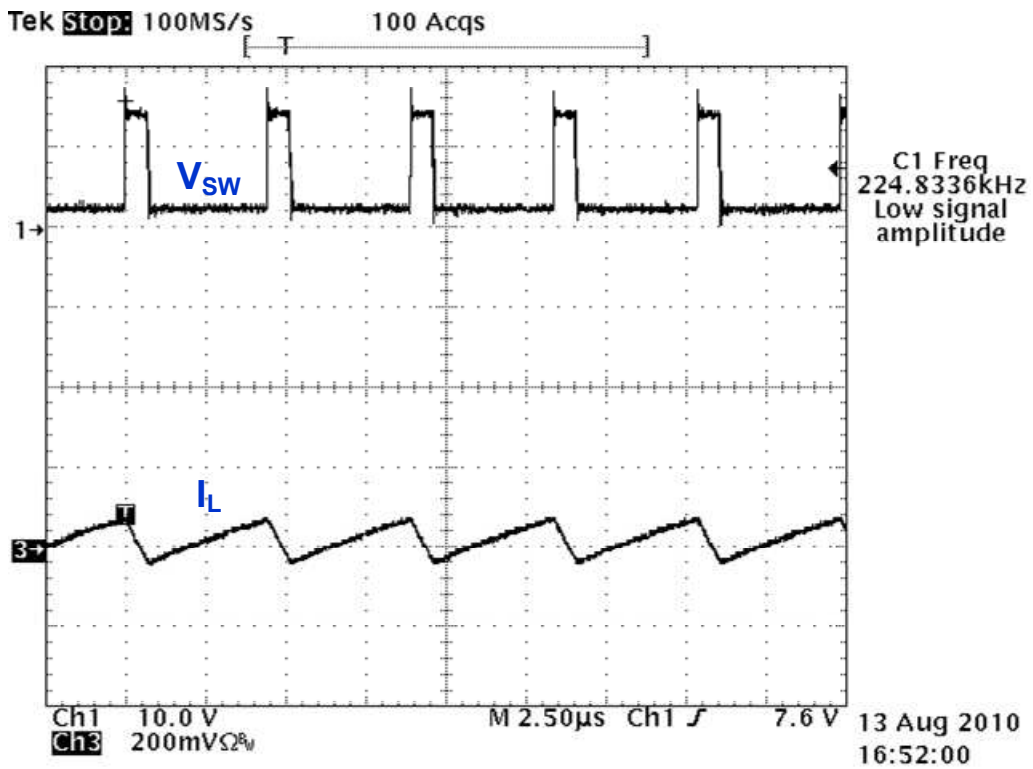

Switching waveform ($V_{IN}=12V$, $R_{SEN}=0.27\Omega$, 3-LED)

Application notes

Setting nominal average output current with external resistor RS

The nominal average output current in the LED(s) is determined by the value of the external current sense resistor (R_S) connected between VIN and Iout and is given by:

$$I_{OUTnom} = 0.1/R_S \text{ [for } R_S \geq 0.1\Omega \text{]}$$

Nominal ripple current is $\pm 15\text{mV}/R_S$

The table below gives values of nominal average output current for several preferred values of current setting resistor (R_S) in the typical application circuit shown on page 3:

$R_S(\Omega)$	Nominal average output current (mA)
0.1	1000
0.13	760
0.15	667

Dimming

A Pulse Width Modulated (PWM) signal with duty cycle DPWM can be applied to the DIM pin. A logic low (below 0.5V) at DIM will disable the internal MOSFET and turn off the current Flow to the LED array. An internal pull-high circuit ensures that The SCT2932 is ON when DIM pin is unconnected.

Open-short Circuit LED Protection

When any LED is open-circuit, the output current will be turned off.

When any LED is short-circuit, the output current will be limited to its preset value.

Over Temperature Protection

When the junction temperature over range. SCT2932 will turn off output current.

Minimum Input Voltage

The Minimum Input Voltage is the sum of the voltage drops on RSEN, DCR of L1, $R_{ds(ON)}$ of Internal MOS switch and the total forward voltage of LEDS V_{LED} .

$$V_{in} = V_{RS} + V_{LED} + V_{L1} + V_{SW}$$

Design Consideration

Switching Frequency

For better output current accuracy, the switching frequency should be determined by minimum on/off time SW waveform.

$FSW=(1-D)/T_{OFF,MIN}$, when the duty cycle is large than 0.5 ($D = V_{out} / V_{in}$), or

$FSW=D/T_{ON,MIN}$, when the duty cycle is smaller than 0.5

The switching frequency is related to efficiency (better at low frequency), the size/cost of components, and the amplitude of output ripple voltage and current (smaller at high frequency). The slower switching frequency comes from the large value of inductor. In many applications, the sensitivity of EMI limits the switching frequency. The switching frequency can be ranged from 40KHz to 1MHz.

LED Ripple Current

A LED constant current driver is designed to control the current through the cascaded LED, instead of the voltage across it. Higher LED ripple current allows the use of smaller inductance, smaller output capacitance and even without an output capacitor. The advantages of higher LED ripple current are to minimize PCB size and reduce cost because of no output capacitor. Lower LED ripple current requires large inductor and output capacitor. The advantages of lower LED ripple Current are to extend LED life time and to reduce heating of LED. The recommended ripple current is from 5% to 20% of normal LED output current.

Capacitor Selection

A low ESR capacitor should be used for input decoupling, as the ESR of this capacitor appears in series with the supply source impedance and lowers overall efficiency. This capacitor has to supply the relatively high peak current to the coil and smooth the current ripple on the input supply.

A minimum value of 4.7uF is acceptable if the input source is close to the device, but higher values will improve performance at lower input voltages, especially when the source impedance is high. The input capacitor should be placed as close as possible to the IC. For maximum stability over temperature and voltage, capacitors with X7R, X5R, or better dielectric are recommended. Capacitors with Y5V dielectric are not suitable for decoupling in this application and should NOT be used. A suitable Murata capacitor would be GRM42-2X7R475K-50.

Inductor Selection

The inductance is determined by two factors: the switching frequency and the inductor ripple current. The calculation of the inductance L1, can be described as:

$$L1 > (V_{IN} - V_{OUT} - V_{SEN} - (R_{ds(ON)} \times I_{OUT})) \times D / (f_{sw} \times \Delta I_L)$$

Higher values of inductance are recommended at higher supply voltages in order to minimize errors due to switching delays, which result in increased ripple and lower efficiency. Higher values of inductance also result in a smaller change in output current over the supply voltage range. (See graphs). The inductor should be mounted as close to the device as possible with low resistance connections to the SW and VIN pins.

The chosen coil should have a saturation current higher than the peak output current and a continuous current rating above the required mean output current.

The inductor value should be chosen to maintain operating duty cycle and switch 'on'/'off' times within the specified limits over the supply voltage and load current range.

Switch on time

$$T_{ON} = L \Delta I / (V_{IN} - V_{LED} - I_{avg} (R_S + rL + R_{SW}))$$

$$T_{OFF} = L \Delta I / (V_{LED} + V_D + I_{avg} (R_S + rL))$$

Where

L is the coil inductance

rL is the coil resistance

R_S is the current sense resistance

I_{avg} is the required LED current

ΔI is the coil peak-peak ripple current (internally set to 0.3 × I_{avg})

V_{IN} is the supply voltage

V_{LED} is the total LED forward voltage

R_{SW} is the switch resistance

V_D is the diode forward voltage at the required load current

Diode Selection

For maximum efficiency and performance, the rectifier (D1) should be a fast low capacitance schottky diode with low reverse leakage at the maximum operating voltage and temperature. They also provide better efficiency than silicon diodes, due to a combination of lower forward voltage and reduced recovery time. It is important to select parts with a peak current rating above the peak coil current and a continuous current rating higher than the maximum output load current. It is very important to consider the reverse leakage of the diode when operating above 85°C. Excess leakage will increase the power dissipation in the device and if close to the load may create a thermal runaway condition. The higher forward voltage and overshoot due to reverse recovery time in silicon diodes will increase the peak voltage on the SW output. If a silicon diode is used, care should be taken to ensure that the total voltage appearing on the SW pin including supply ripple, does not exceed the specified maximum value.

Package Dimension

TO252-5

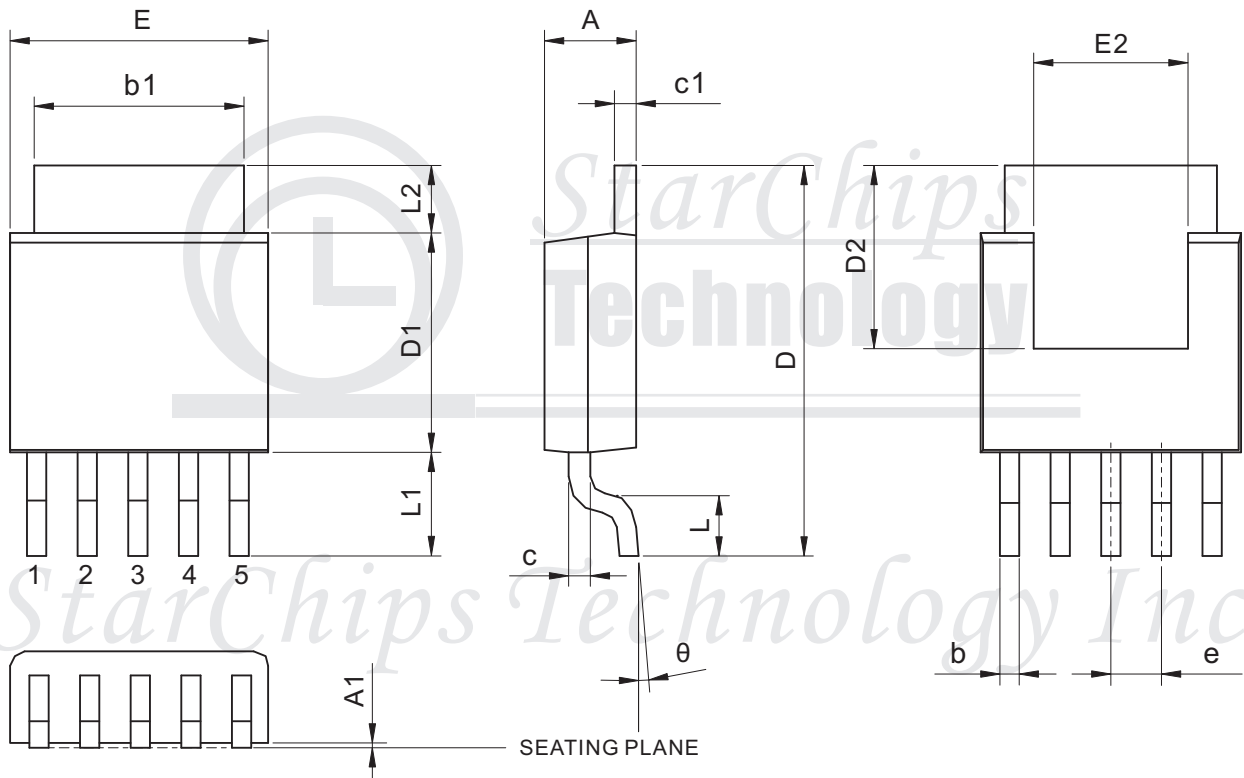

Symbol	Dimension (mm)			Dimension (mil)		
	Min.	Nom.	Max.	Min.	Nom.	Max.
A	2.10	2.30	2.50	82.7	90.6	98.4
A1	0.00	0.20	0.30	0.0	7.9	11.8
b	-	-	-	-	-	-
b1	4.80	5.00	5.20	189.0	196.9	204.7
c	-	-	-	-	-	-
c1	0.40	0.50	0.60	15.7	19.7	23.6
D	-	-	-	-	-	-
D1	-	5.50	-	-	216.5	-
D2	-	-	-	-	-	-
E	-	-	6.70	-	-	263.8
E2	-	-	-	-	-	-
e	1.30 BSC			51.2 BSC		
L	0.90	1.20	1.50	35.4	47.2	59.1
L1	-	2.50	-	-	98.4	-
L2	1.20	1.50	1.80	47.2	59.1	70.9.0
θ	-	-	-	-	-	-

SOT23-5

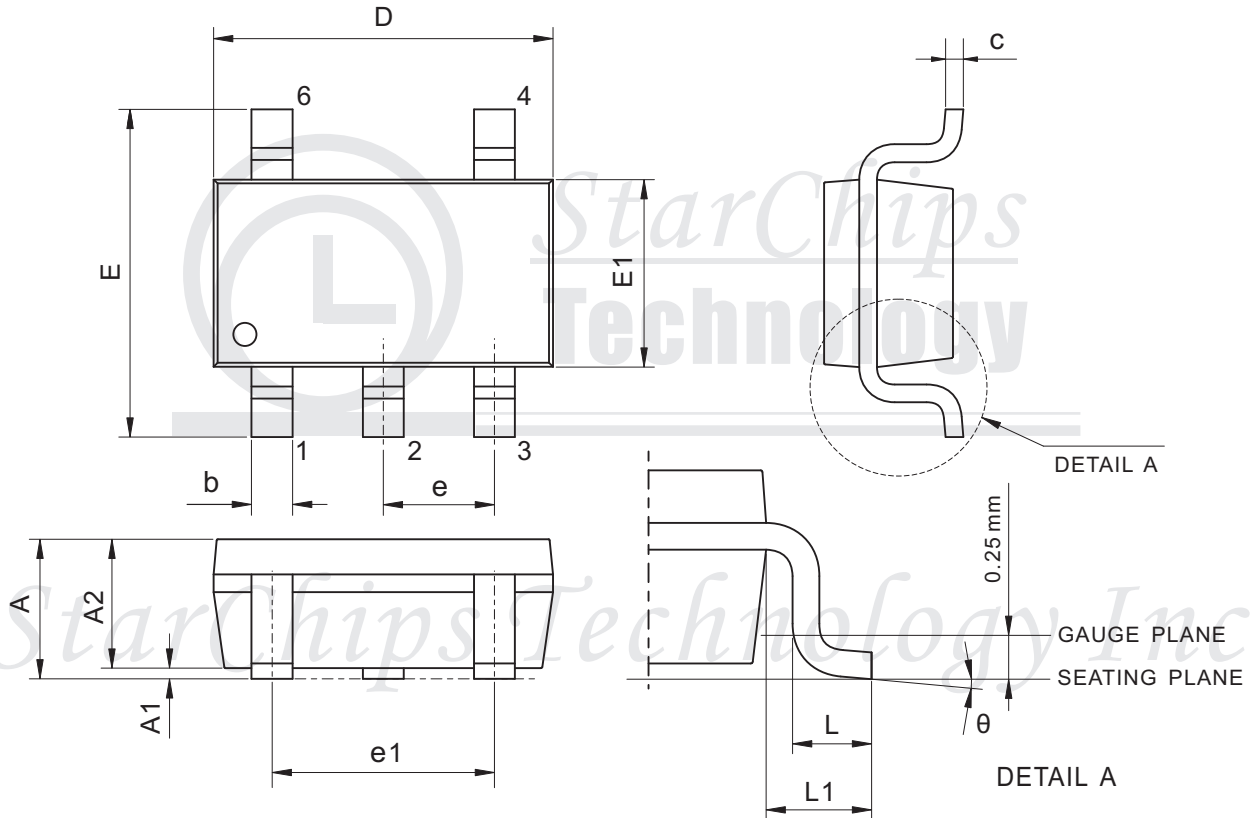

Symbol	Dimension (mm)			Dimension (mil)		
	Min.	Nom.	Max.	Min.	Nom.	Max.
A	-	-	1.00	-	-	39.3
A1	0.01	-	0.10	0.3	-	3.9
A2	0.84	-	0.90	33.0	-	35.4
b	0.30	-	0.45	11.8	-	17.7
c	0.12	-	0.20	4.7	-	7.8
D	2.90 BSC			114.0 BSC		
E	2.80 BSC			110.0 BSC		
E1	1.60 BSC			62.0 BSC		
e	0.95 BSC			37.4 BSC		
e1	1.90 BSC			74.8 BSC		
L	0.30	-	0.50	11.8	-	19.6
L1	-	-	-	-	-	-
θ	4°	-	12°	4°	-	12°

MSOP8TP

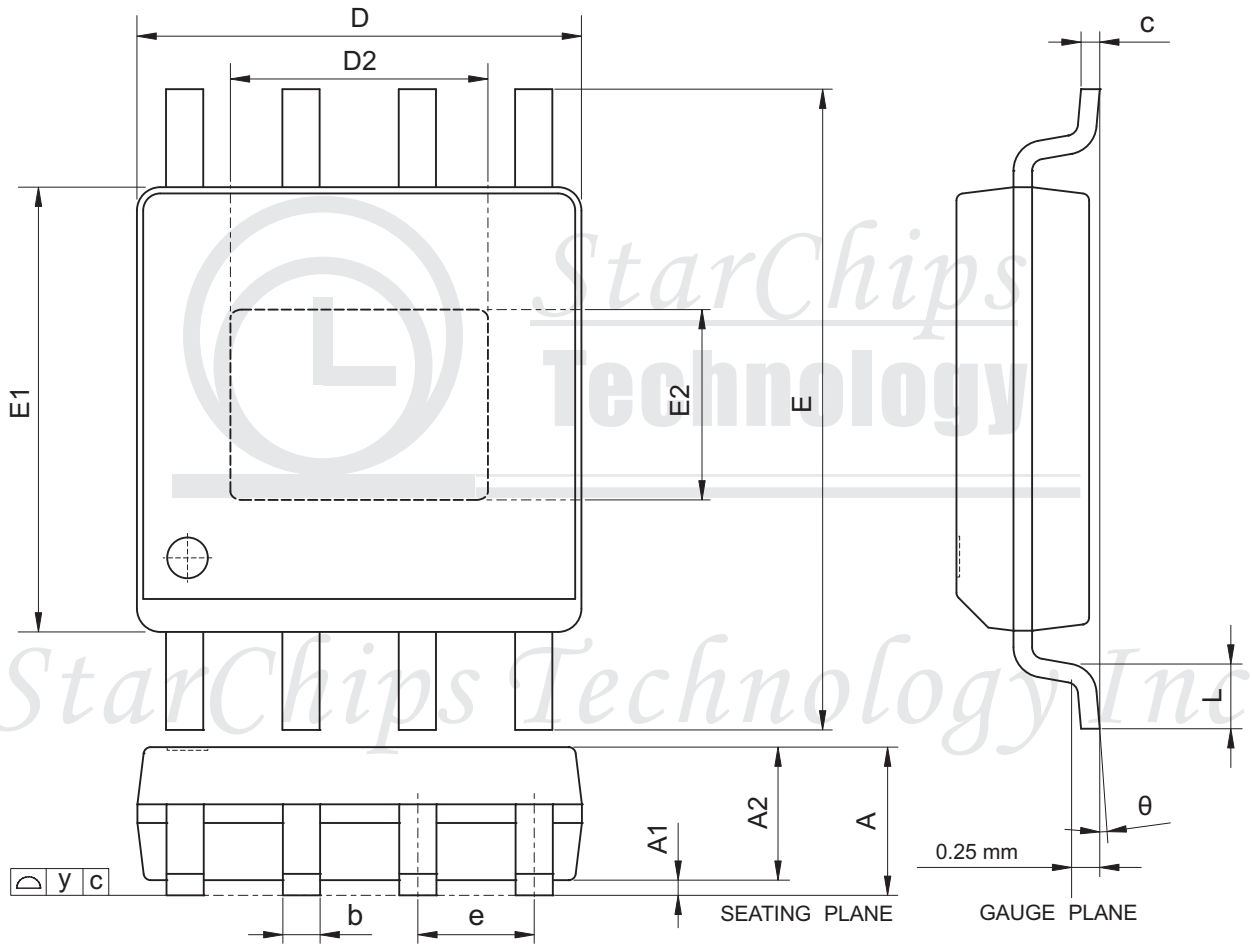

Symbol	Dimension (mm)			Dimension (mil)		
	Min.	Nom.	Max.	Min.	Nom.	Max.
A	0.81	1.02	1.10	32.0	40.0	43.0
A1	0.05	-	0.15	2.0	-	6.0
A2	0.76	0.86	0.95	30.0	34.0	37.0
b	0.28	0.30	0.38	11.0	12.0	15.0
c	0.13	0.15	0.23	5.0	6.0	9.0
D	2.90	3.00	3.10	114.0	118.0	122.0
E	4.75	6.00	6.20	187.0	193.0	199.0
E1	2.90	3.00	3.10	114.0	118.0	12.0
e	0.65 BSC			26.0 BSC		
L	0.40	0.55	0.70	16.0	22.0	28.0
y	-	-	0.10	-	-	3.9
θ	0°	3°	6°	0°	3°	6°

SOP8TP

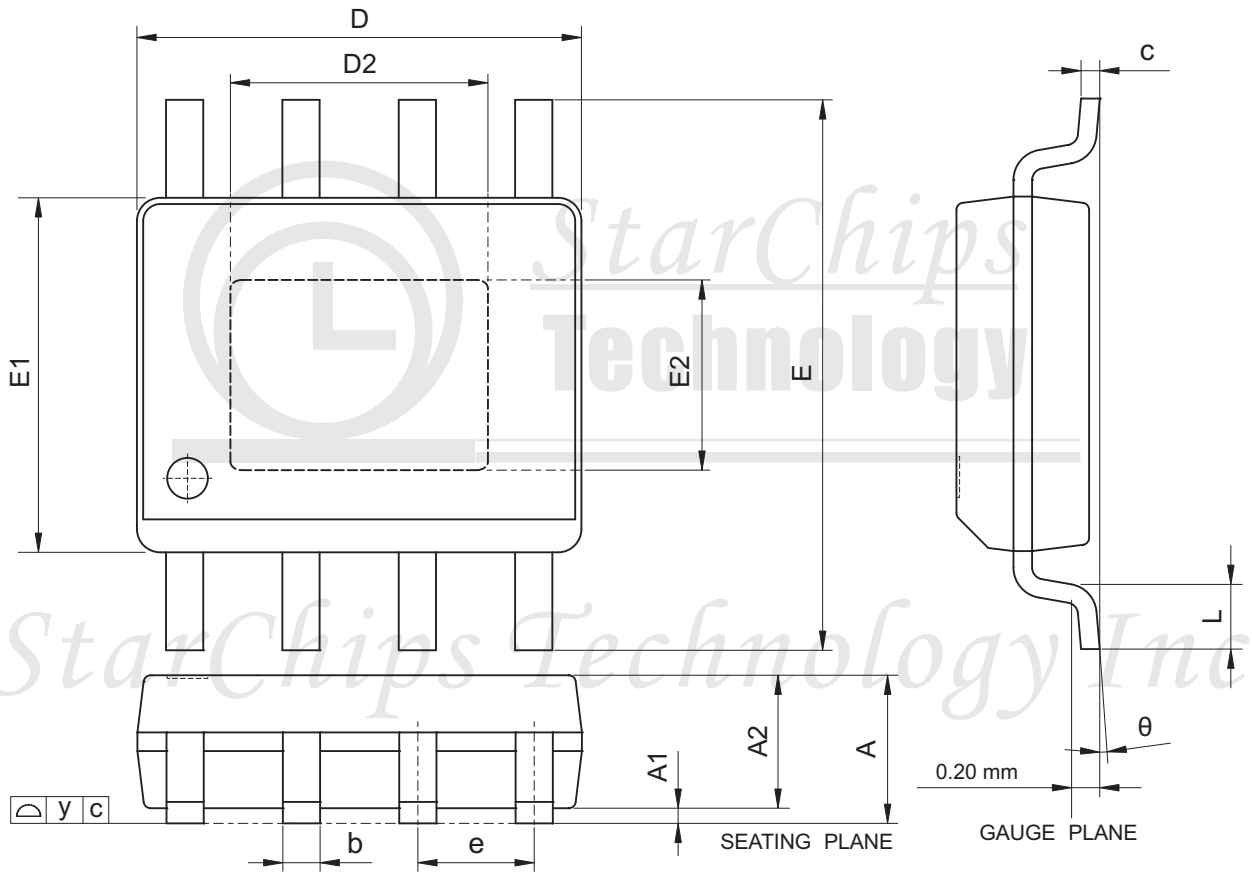

Symbol	Dimension (mm)			Dimension (mil)		
	Min.	Nom.	Max.	Min.	Nom.	Max.
A	1.35	-	1.75	53.0	-	69.0
A1	0.10	-	0.25	4.0	-	10.0
A2	-	-	1.5	-	-	59.0
b	0.41			16.0 TYP		
c	0.20 TYP			8.0 TYP		
D	4.80	-	4.98	189.0	-	196.0
E	5.79	-	6.20	228.0	-	244.0
E1	3.81	-	3.99	150.0	-	157.0
D2	-	2.29	-	-	90.0	-
E2	-	2.29	-	-	90.0	-
e	1.27 TYP			50.0 TYP		
L	0.41	-	1.27	16.0	-	50.0
y	-	-	0.10	-	-	4.0
θ	0°	-	8°	0°	-	8°

SOT89-5

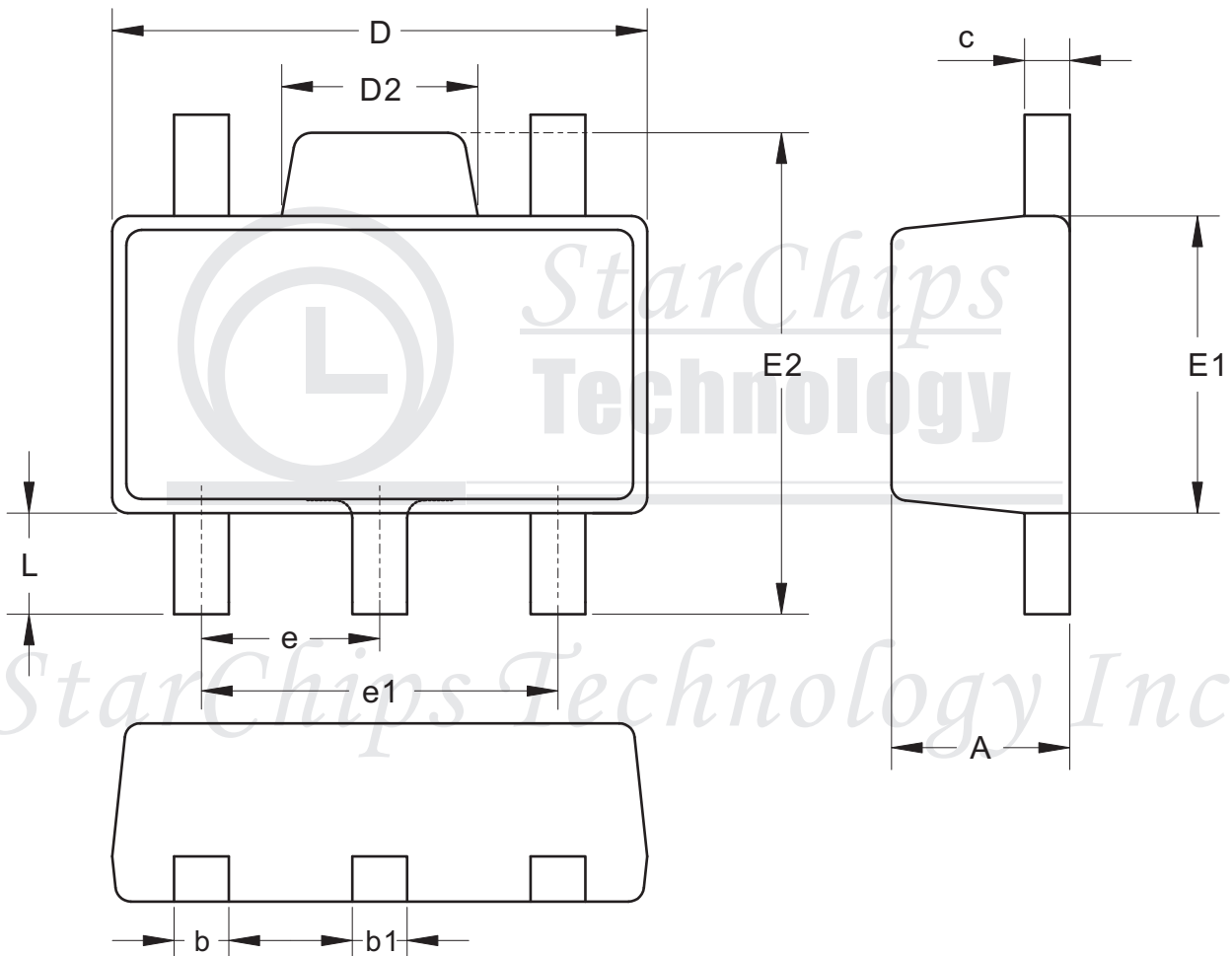

Symbol	Dimension (mm)			Dimension (mil)		
	Min.	Nom.	Max.	Min.	Nom.	Max.
A	1.40	-	1.60	55.0	-	63.0
b	0.32	-	0.52	13.0	-	20.0
b1	0.36	-	0.56	14.0	-	22.0
c	0.35	-	0.44	14.0	-	17.0
D	4.40	-	4.60	173.0	-	181.0
E1	2.30	-	2.60	91.0	-	102.0
D2	1.40	-	1.80	55.0	-	71.0
E2	3.94	-	4.25	155.0	-	167.0
e	1.50 TYP			60.0 TYP		
e1	2.90	-	3.10	114.0	-	122.0
L	0.90	-	1.10	35.0	-	43.0

Revision History ([check up-to-date version](#))

Data Sheet Version	Remark
V02_01	Output current update to 1.5A; remove SOT23-6 package

Information provided by StarChips Technology is believed to be accurate and reliable. Application circuits shown, if any, are typical examples illustrating the operation of the devices. StarChips can not assume responsibility and any problem raising out of the use of the circuits. StarChips reserves the right to change product specification without prior notice.