



HESTORE.HU

elektronikai alkatrész áruház

EN: This Datasheet is presented by the manufacturer.

Please visit our website for pricing and availability at www.hestore.hu.

Automotive Relays
CT RELAYS

Product Catalog

**IN Your
Future**

CT RELAYS

Small & Slim Twin/1 Form C type Automotive Relay

[Protective construction] Sealed

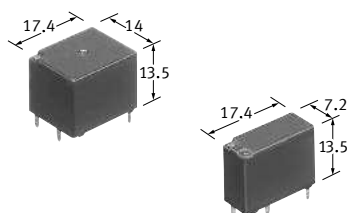

(Unit: mm)

FEATURES

- Terminal layout for simplifying PC board pattern design.
- Capable of 25 A high-capacity load switching with compact size.

TYPICAL APPLICATIONS

- Powered windows, Automatic door locks, Powered mirrors, Powered sunroof, Powered seats, Lift gates and Slide door closers, etc.

ORDERING INFORMATION (PART NO.)

ACT

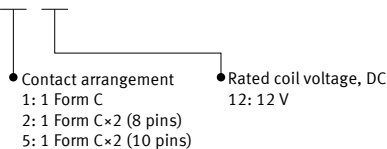

TYPES

Contact arrangement	Rated coil voltage	Part No.	Packing	
			Carton (1-tube)	Case
1 Form C	12 V DC	ACT112	30 pcs.	1,500 pcs.
1 Form C x 2 (8 pins)		ACT212	30 pcs.	900 pcs.
1 Form C x 2 (10 pins)		ACT512		

RATING

Coil data

Rated coil voltage	Operate voltage (at 20°C) (initial)	Release voltage (at 20°C) (initial)	Rated operating current [±10%] (at 20°C)	Coil resistance [±10%] (at 20°C)	Rated operating power (at 20°C)	Usable voltage range
12 V DC	Max. 7.2 V DC	Min. 1.0 V DC	66.7 mA	180 Ω	800 mW	10 to 16 V DC

Note: Other operate voltage types are also available. Please inquire our sales representative for details.

Automotive Relays CT RELAYS

Specifications

Item		Specifications
Contact data	Contact arrangement	1 Form C x 2, 1 Form C
	Contact resistance (initial)	Max. 100 mΩ (N.O. side: typ. 7 mΩ, N.C. side: typ. 10 mΩ) (By voltage drop 1 A 6 V DC)
	Contact material	Ag alloy
	Rated switching capacity (resistive)	N.O. side: 20 A 14 V DC, N.C. side: 10 A 14 V DC
	Max. carrying current*1	N.O. side: 25 A/1 hour, 35 A/2 min (Coil applied voltage 14 V DC, at 20°C)
	Min. switching load (resistive)*2	1 A 14 V DC (at 20°C)
Insulated resistance (initial)		Min. 100 MΩ (at 500 V DC, Measurement at same location as "Dielectric strength" section.)
Dielectric strength (initial)	Between open contacts	500 Vrms for 1 min (Detection current: 10 mA)
	Between contacts and coil	500 Vrms for 1 min (Detection current: 10 mA)
Time characteristics (initial)	Operate time (at rated voltage)	Max. 10 ms (at 20°C, without contact bounce time)
	Release time (at rated voltage)	Max. 10 ms (at 20°C, without contact bounce time) (without diode)
Shock resistance	Functional	Min. 100 m/s ² (Half-wave pulse of sine wave: 11 ms, detection time: 10 μs)
	Destructive	Min. 1,000 m/s ² (Half-wave pulse of sine wave: 6 ms)
Vibration resistance	Functional	10 to 100 Hz, Min. 44.1 m/s ² (Detection time: 10 μs)
	Destructive	10 to 500 Hz, Min. 44.1 m/s ² (Time of vibration for each direction; X, Y direction: 2 hours, Z direction: 4 hours)
Expected life	Mechanical	Min. 10 x 10 ⁶ (at 120 times/min)
	Electrical	<Resistive load> Min. 10 ⁵ (at rated switching capacity, operating frequency: 1 s ON, 9 s OFF) <Motor load> N.O. side: Min. 2 x 10 ⁵ at inrush 25 A, steady 5 A 14 V DC Min. 10 ⁵ at 25 A 14 V DC motor lock condition N.C. side: Min. 2 x 10 ⁵ at break current 20 A 14 V DC (operating frequency: 0.5 s ON, 9.5 s OFF)
Conditions	Conditions for usage, transport and storage*3	Ambient temperature: -40 to +85°C, Humidity: 5 to 85% RH (Avoid icing and condensation)
Weight		Approx. 8 g (twin type), Approx. 4 g (1 Form C type)

Notes: *1.Depend on connection conditions. Also, this does not guarantee repeated switching. We recommend that you confirm operation under actual conditions.

*2.This value can change due to the switching frequency, environmental conditions, and desired reliability level, therefore it is recommended to check this with the actual load.

*3.The upper operation ambient temperature limit is the maximum temperature that can satisfy the coil temperature rise value. For details, please refer to the "Automotive Relay Users Guide".

Please inquire our sales representative if you will be using the relay in a high temperature atmosphere (110°C).

★If the relay is used continuously for long periods of time with coils on both sides in an energized condition, breakdown might occur due to abnormal heating depending on the carrying condition. Therefore, please inquire our sales representative when using with a circuit that causes an energized condition on both sides simultaneously.

REFERENCE DATA

1-1. Coil temperature rise (at room temperature)

Sample: ACT212, 3 pcs.
Carrying current: 0 A, 10 A, 20 A
Ambient temperature: Room temperature

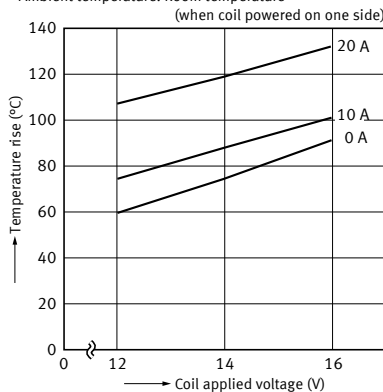

1-2. Coil temperature rise (at 85°C)

Sample: ACT212, 3 pcs.
Carrying current: 0 A, 10 A, 20 A
Ambient temperature: 85°C

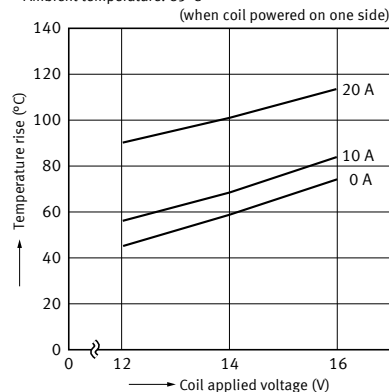

2. Max. switching capability (Resistive load, initial)

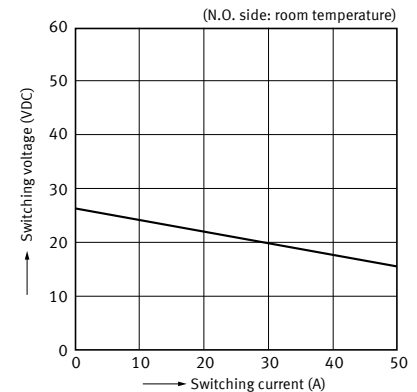

3. Ambient temperature and usable voltage range

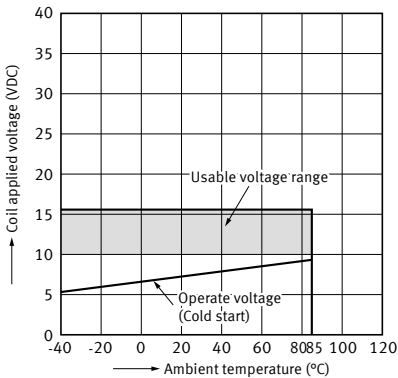

4. Distribution of operate and release voltage

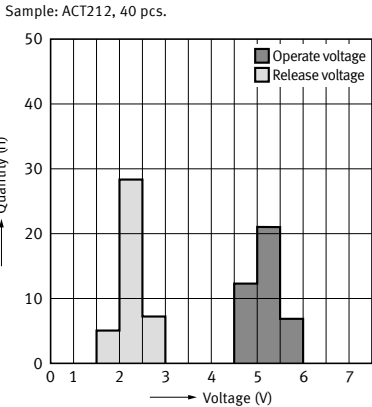

5. Distribution of operate and release time

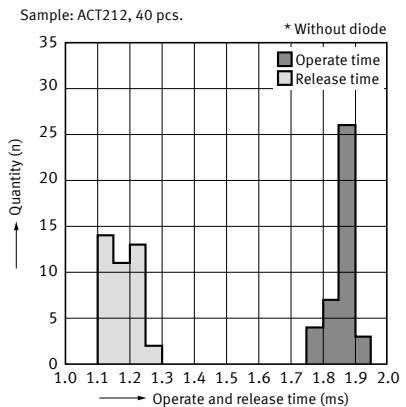

6-1. Electrical life test (Motor free)

Sample: ACT212, 3 pcs.
 Load: Inrush 25 A, steady 5 A
 Brake current: 13 A 14 V DC,
 Power window motor actual load (free condition)
 Operating frequency: ON 0.5 s, OFF 9.5 s
 Ambient temperature: Room temperature
 Circuit:

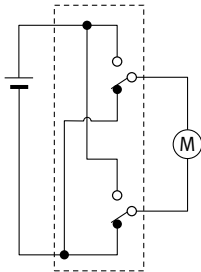

Change of operate and release voltage

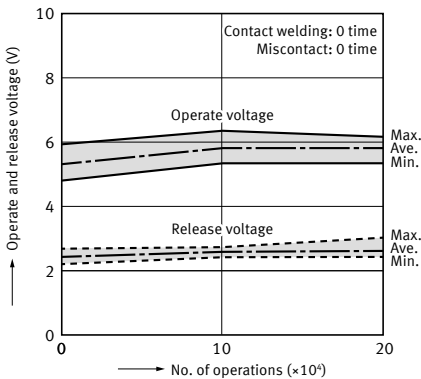

Change of contact resistance

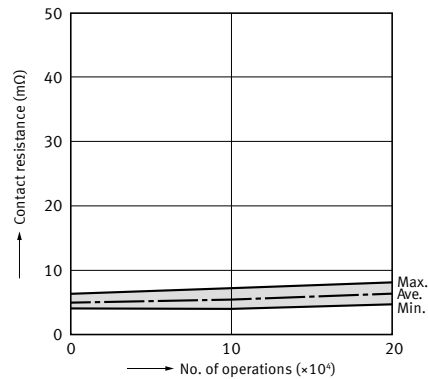

Load current waveform

Load: Inrush current: 25 A, Steady current: 6 A
 Brake current: 13 A

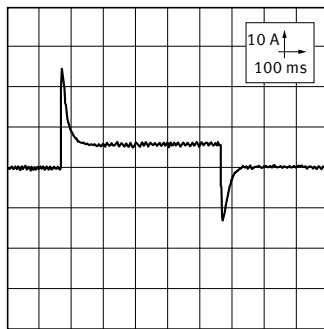

6-2. Electrical life test (Motor lock)

Sample: ACT212, 3 pcs.
 Load: 25 A 14 V DC
 Power window motor actual load (lock condition)
 Operating frequency: ON 0.5 s, OFF 9.5 s
 Ambient temperature: Room temperature
 Circuit:

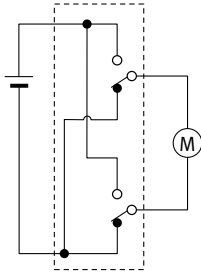

Change of operate and release voltage

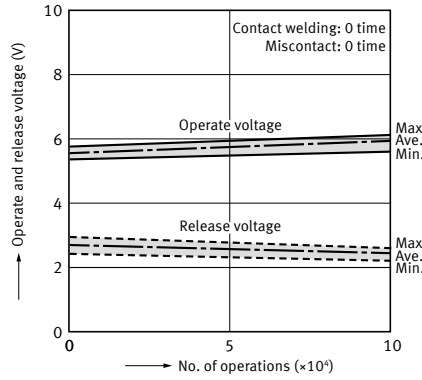

Change of contact resistance

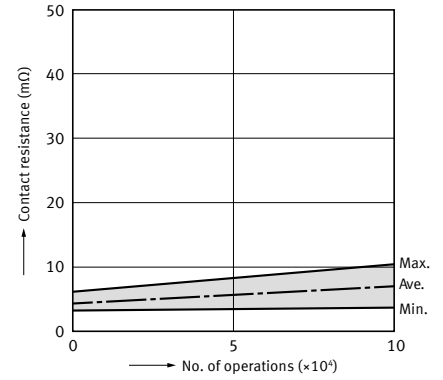

Load current waveform

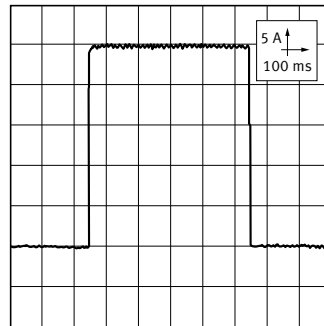

6-3. Electrical life test (Motor lock)

Sample: ACT212, 3 pcs.
 Load: 20 A 14 V DC,
 door lock motor actual load (Lock condition)
 Operating frequency: ON 0.3 s, OFF 19.7 s
 Ambient temperature: Room temperature
 Circuit:

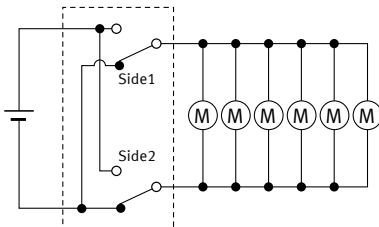

Change of operate and release voltage

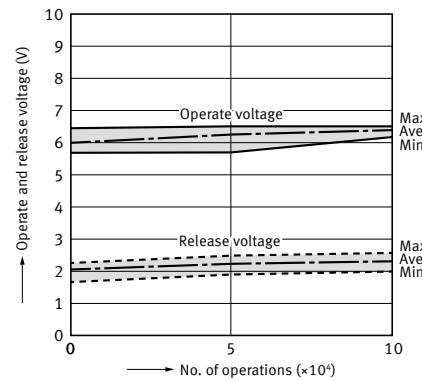

Change of contact resistance

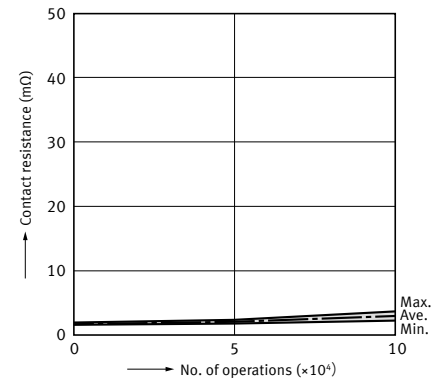

Load current waveform

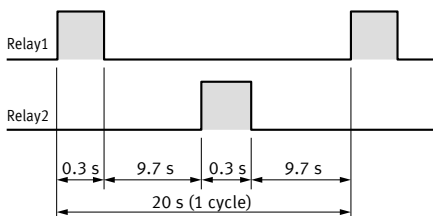
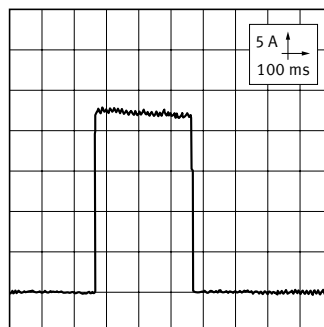

DIMENSIONS

CAD The CAD data of the products with a "CAD" mark can be downloaded from our Website.

Unit: mm

Twin type (8 pins)

CAD



External dimensions

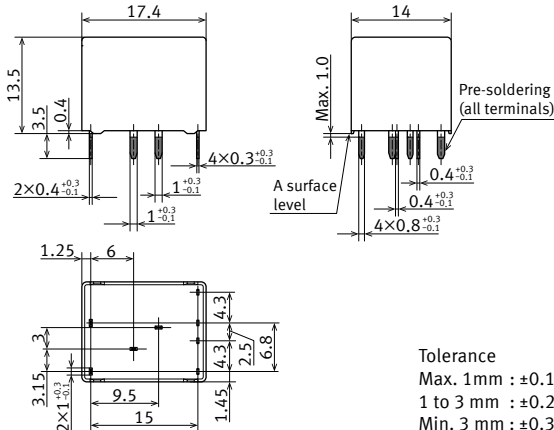

PC board pattern (BOTTOM VIEW)

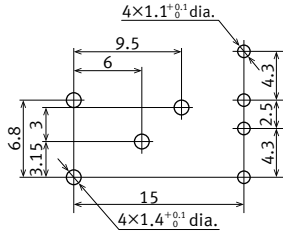

Tolerance: ±0.1

Schematic (BOTTOM VIEW)

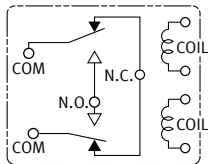

Tolerance
Max. 1mm : ±0.1
1 to 3 mm : ±0.2
Min. 3 mm : ±0.3

* Dimensions (thickness and width) of terminal is measured after pre-soldering. Intervals between terminals is measured at A surface level.

Twin type (10 pins)

CAD



External dimensions

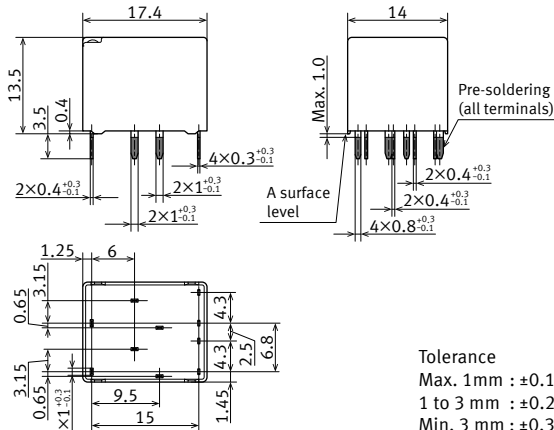

PC board pattern (BOTTOM VIEW)

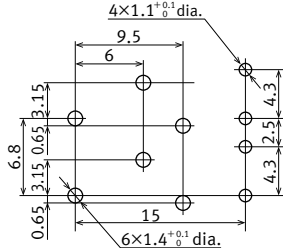

Tolerance: ±0.1

Schematic (BOTTOM VIEW)

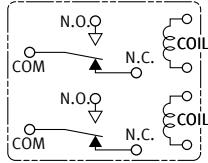

Tolerance
Max. 1mm : ±0.1
1 to 3 mm : ±0.2
Min. 3 mm : ±0.3

* Dimensions (thickness and width) of terminal is measured after pre-soldering. Intervals between terminals is measured at A surface level.

Slim 1 Form C type

CAD



External dimensions

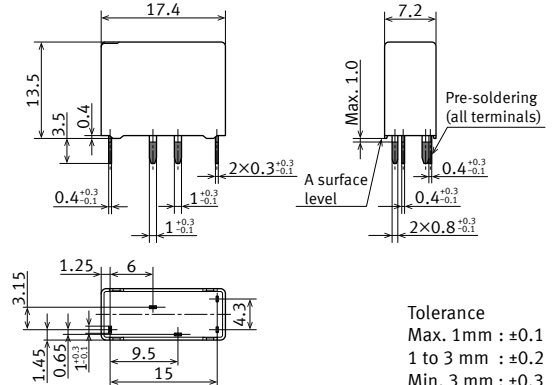

PC board pattern (BOTTOM VIEW)

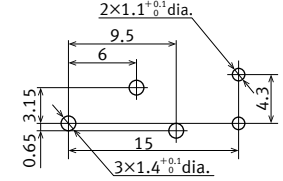

Tolerance: ±0.1

Schematic (BOTTOM VIEW)

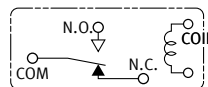

Tolerance
Max. 1mm : ±0.1
1 to 3 mm : ±0.2
Min. 3 mm : ±0.3

* Dimensions (thickness and width) of terminal is measured after pre-soldering. Intervals between terminals is measured at A surface level.

Automotive Relays CT RELAYS

EXAMPLE OF CIRCUIT

Forward/reverse control circuits of DC motor for powered windows and sunroof, etc.

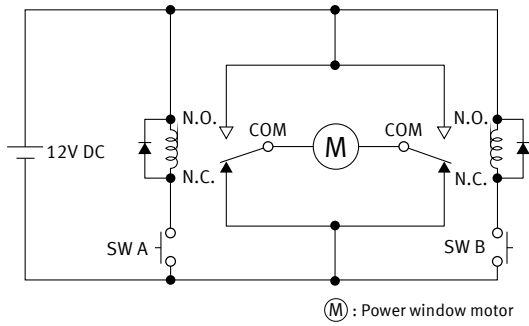

GUIDELINES FOR USAGE

■ For general cautions for use, please refer to the "Automotive Relay Users Guide".

Please refer to **"the latest product specifications"** when designing your product.
•Requests to customers:
<https://industrial.panasonic.com/ac/e/salespolicies/>



Panasonic Industry Co., Ltd.

Electromechanical Control Business Division
■1006, Oaza Kadoma, Kadoma-shi, Osaka 571-8506, Japan
industrial.panasonic.com/ac/e/