



**HESTORE.HU**

elektronikai alkatrész áruház

**EN:** This Datasheet is presented by the manufacturer.

Please visit our website for pricing and availability at [www.hestore.hu](http://www.hestore.hu).

## 12 A Snubberless™, logic level and standard triacs

### Features

- Medium current triac
- Low thermal resistance with clip bonding
- Low thermal resistance insulation ceramic for insulated BTA
- High commutation (4Q) or very high commutation (3Q) capability
- BTA series UL1557 certified (File ref: 81734)
- Packages are RoHS ( 2002/95/EC) compliant

### Applications

ON/OFF or phase angle function in applications such as static relays, light dimmers and appliance motors speed controllers.

The snubberless versions (BTA/BTB...W and T12 series) are especially recommended for use on inductive loads, because of their high commutation performances. The BTA series provides an insulated tab (rated at 2500 V RMS).

### Description

Available either in through-hole or surface-mount packages, the **BTA12**, **BTB12** and **T12xx** triac series is suitable for general purpose mains power AC switching.

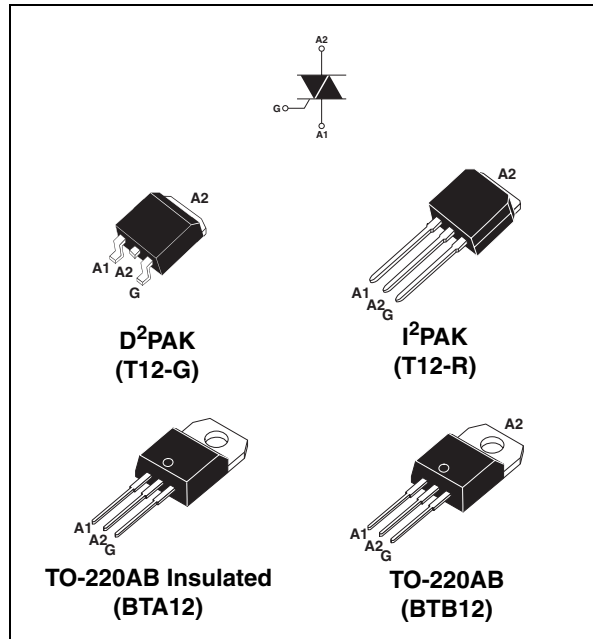

### Order code

See [Ordering information on page 11](#)

**Table 1. Device summary**

Symbol	Parameter	T12xx	BTA12 <sup>(1)</sup>	BTB12
$I_{T(RMS)}$	RMS on-state current	12	12	12
$V_{DRM}/V_{RRM}$	Repetitive peak off-state voltage	600/800	600/800	600/800
$I_{GT}$ (Snubberless)	Triggering gate current	10/35/50	5/10/35/50	5/10/35/50
$I_{GT}$ (Standard)	Triggering gate current	-	35/50	35/50

1. Insulated

TM: Snubberless is a trademark of STMicroelectronics

# 1 Characteristics

**Table 2. Absolute maximum ratings**

Symbol	Parameter			Value	Unit	
$I_{T(RMS)}$	RMS on-state current (full sine wave)	$I^2PAK / D^2PAK / TO-220AB$	$T_c = 105^\circ C$	12	A	
		TO-220AB Ins.	$T_c = 90^\circ C$			
$I_{TSM}$	Non repetitive surge peak on-state current (full cycle, $T_j$ initial = $25^\circ C$ )	$F = 50 Hz$	$t = 20 ms$	120	A	
		$F = 60 Hz$	$t = 16.7 ms$	126		
$I^2t$	$I^2t$ Value for fusing	$t_p = 10 ms$		78	$A^2s$	
$di/dt$	Critical rate of rise of on-state current $I_G = 2 \times I_{GT}$ , $t_r \leq 100 ns$	$F = 120 Hz$	$T_j = 125^\circ C$	50	$A/\mu s$	
$V_{DSM}/V_{RSM}$	Non repetitive surge peak off-state voltage	$t_p = 10 ms$	$T_j = 25^\circ C$	$V_{DRM}/V_{RRM} + 100$	V	
$I_{GM}$	Peak gate current	$t_p = 20 \mu s$	$T_j = 125^\circ C$	4	A	
$P_{G(AV)}$	Average gate power dissipation	$T_j = 125^\circ C$		1	W	
$T_{stg}$ $T_j$	Storage junction temperature range Operating junction temperature range				- 40 to + 150 - 40 to + 125	$^\circ C$

**Table 3. Electrical characteristics ( $T_j = 25^\circ C$ , unless otherwise specified)  
Snubberless and logic level (3 quadrants)**

Symbol	Test conditions	Quadrant		T12xx			BTA12 / BTB12				Unit
				T1210	T1235	T1250	TW	SW	CW	BW	
$I_{GT}^{(1)}$	$V_D = 12 V$ $R_L = 30 \Omega$	I - II - III	MAX.	10	35	50	5	10	35	50	mA
$V_{GT}$		I - II - III	MAX.	1.3						V	
$V_{GD}$	$V_D = V_{DRM}$ $R_L = 3.3 k\Omega$ $T_j = 125^\circ C$	I - II - III	MIN.	0.2						V	
$I_H^{(2)}$	$I_T = 100 mA$		MAX.	15	35	50	10	15	35	50	mA
$I_L$	$I_G = 1.2 I_{GT}$	I - III	MAX.	25	50	70	10	25	50	70	mA
		II		30	60	80	15	30	60	80	
$dV/dt^{(2)}$	$V_D = 67 \% V_{DRM}$ gate open $T_j = 125^\circ C$		MIN.	40	500	1000	20	40	500	1000	$V/\mu s$
$(di/dt)_c^{(2)}$	$(dV/dt)_c = 0.1 V/\mu s$ $T_j = 125^\circ C$		MIN.	6.5			3.5	6.5			$A/ms$
	$(dV/dt)_c = 10 V/\mu s$ $T_j = 125^\circ C$			2.9			1	2.9			
	Without snubber $T_j = 125^\circ C$				6.5	12			6.5	12	

1. Minimum  $I_{GT}$  is guaranteed at 5% of  $I_{GT} max$
2. for both polarities of A2 referenced to A1

**Table 4. Electrical characteristics ( $T_j = 25^\circ\text{C}$ , unless otherwise specified) standard (4 quadrants)**

Symbol	Test Conditions	Quadrant		BTA12 / BTB12		Unit
				C	B	
$I_{GT}^{(1)}$	$V_D = 12\text{ V}$ $R_L = 30\ \Omega$	I - II - III IV	MAX.	25 50	50 100	mA
$V_{GT}$		ALL	MAX.	1.3		V
$V_{GD}$	$V_D = V_{DRM}$ $R_L = 3.3\text{ k}\Omega$ $T_j = 125^\circ\text{ C}$	ALL	MIN.	0.2		V
$I_H^{(2)}$	$I_T = 500\text{ mA}$		MAX.	25	50	mA
$I_L$	$I_G = 1.2 I_{GT}$	I - III - IV	MAX.	40	50	mA
		II		80	100	
$dV/dt^{(2)}$	$V_D = 67\% V_{DRM}$ gate open $T_j = 125^\circ\text{ C}$		MIN.	200	400	V/ $\mu\text{s}$
$(dI/dt)_c^{(2)}$	$(dI/dt)_c = 5.3\text{ A/ms}$ $T_j = 125^\circ\text{ C}$		MIN.	5	10	V/ $\mu\text{s}$

1. Minimum  $I_{GT}$  is guaranteed at 5% of  $I_{GT}$  max.
2. for both polarities of A2 referenced to A1.

**Table 5. Static characteristics**

Symbol	Test conditions			Value	Unit	
$V_T^{(1)}$	$I_{TM} = 17\text{ A}$	$t_p = 380\ \mu\text{s}$	$T_j = 25^\circ\text{ C}$	MAX.	1.55	V
$V_{i0}^{(1)}$	Threshold voltage		$T_j = 125^\circ\text{ C}$	MAX.	0.85	V
$R_d^{(1)}$	Dynamic resistance		$T_j = 125^\circ\text{ C}$	MAX.	35	m $\Omega$
$I_{DRM}$ $I_{RRM}$	$V_{DRM} = V_{RRM}$		$T_j = 25^\circ\text{ C}$	MAX.	5	$\mu\text{A}$
			$T_j = 125^\circ\text{ C}$		1	mA

1. for both polarities of A2 referenced to A1

**Table 6. Thermal resistance**

Symbol	Parameter		Value	Unit	
$R_{th(j-c)}$	Junction to case (AC)		I <sup>2</sup> PAK / D <sup>2</sup> PAK / TO-220AB	1.4	$^\circ\text{C/W}$
			TO-220AB insulated	2.3	
$R_{th(j-a)}$	Junction to ambient	$S^{(1)} = 1\text{ cm}^2$	D <sup>2</sup> PAK	45	$^\circ\text{C/W}$
			TO-220AB / I <sup>2</sup> PAK TO-220AB insulated	60	

1. Copper surface under tab.

Figure 1. Maximum power dissipation versus RMS on-state current (full cycle)

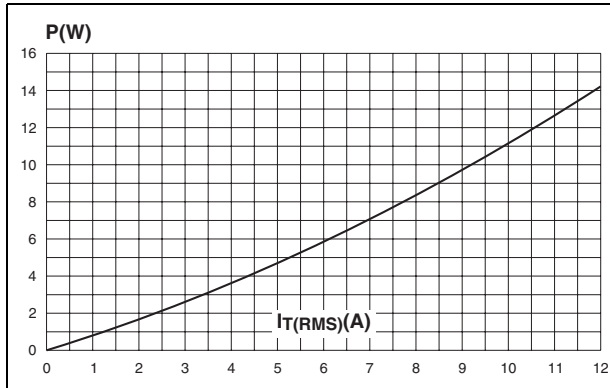

Figure 2. RMS on-state current versus case temperature (full cycle)

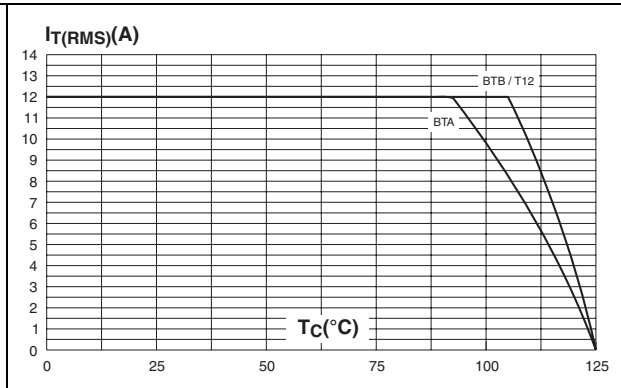

Figure 3. RMS on-state current versus ambient temperature (printed circuit board FR4, copper thickness: 35µm) (full cycle)

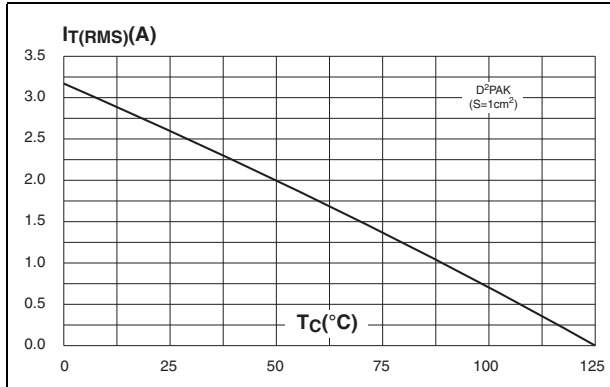

Figure 4. Relative variation of thermal impedance versus pulse duration

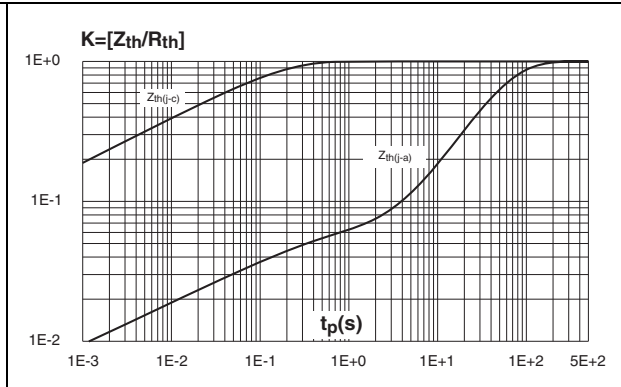

Figure 5. On-state characteristics (maximum values)

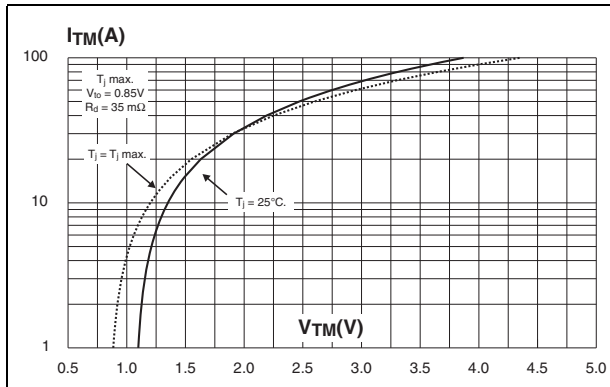
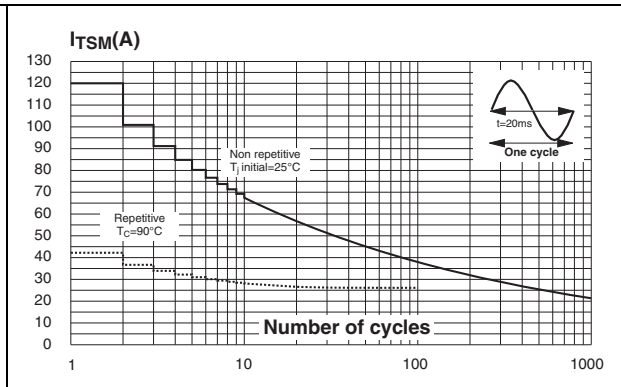
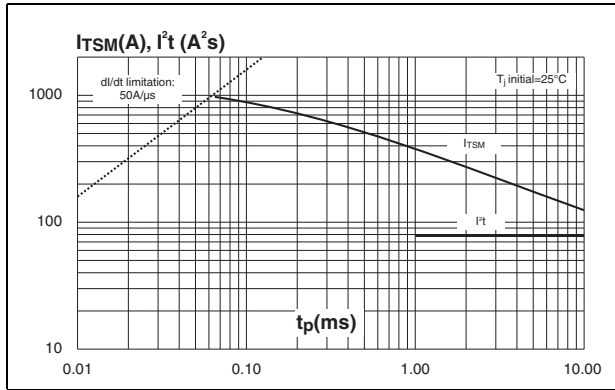

Figure 6. Surge peak on-state current versus number of cycles



**Figure 7. Non-repetitive surge peak on-state current for a sinusoidal pulse with width  $t_p < 10$  ms and corresponding value of  $I^2t$**



**Figure 8. Figure 8: Relative variation of gate trigger current, holding current and latching current versus junction temperature (typical values)**

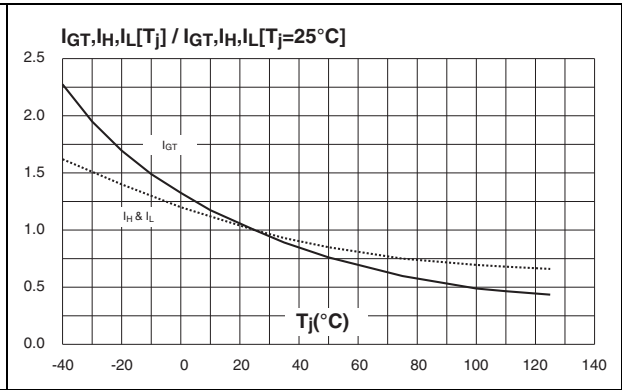

**Figure 9. Relative variation of critical rate of decrease of main current versus  $(dV/dt)_c$  (typical values) (BW/CW/T1210/T1235)**

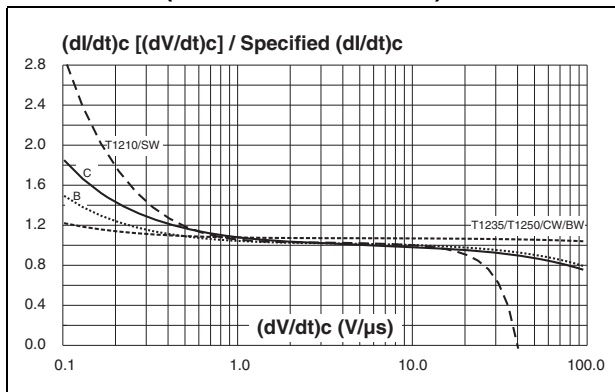

**Figure 10. Relative variation of critical rate of decrease of main current versus  $(dV/dt)_c$  (typical values) (TW)**

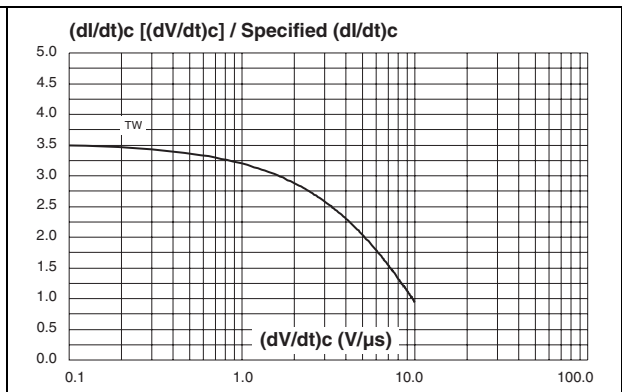

**Figure 11. Relative variation of critical rate of decrease of main current versus junction temperature**

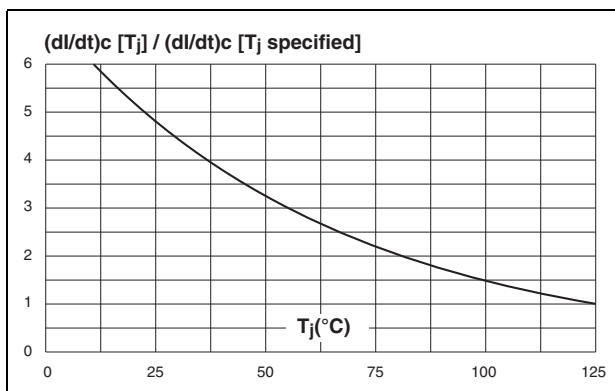

**Figure 12. D<sup>2</sup>PAK thermal resistance junction to ambient versus copper surface under tab (printed circuit board FR4, copper thickness: 35  $\mu\text{m}$ )**

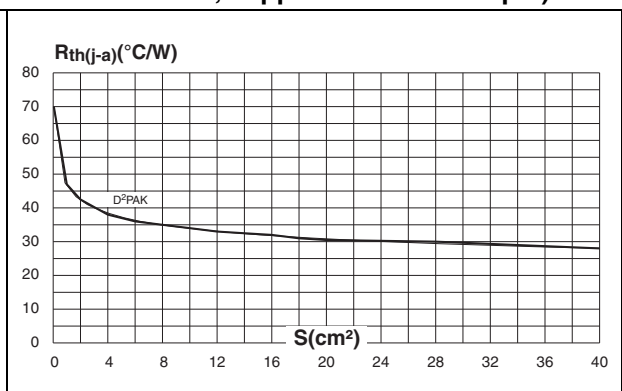

## 2 Ordering information scheme

Figure 13. BTA12 and BTB12 series

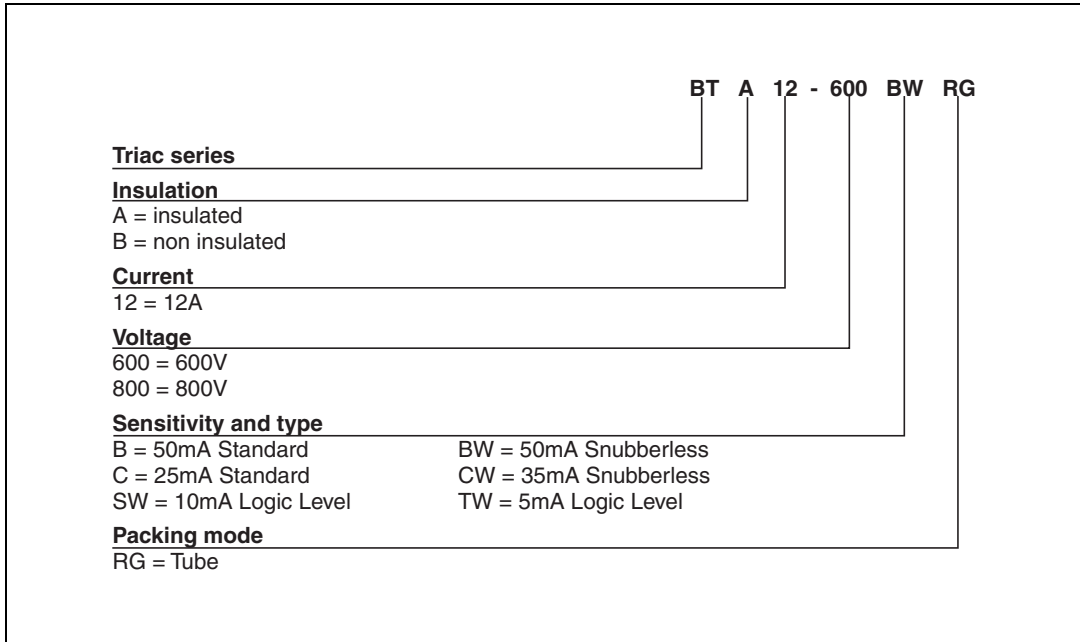

Figure 14. T12xx series

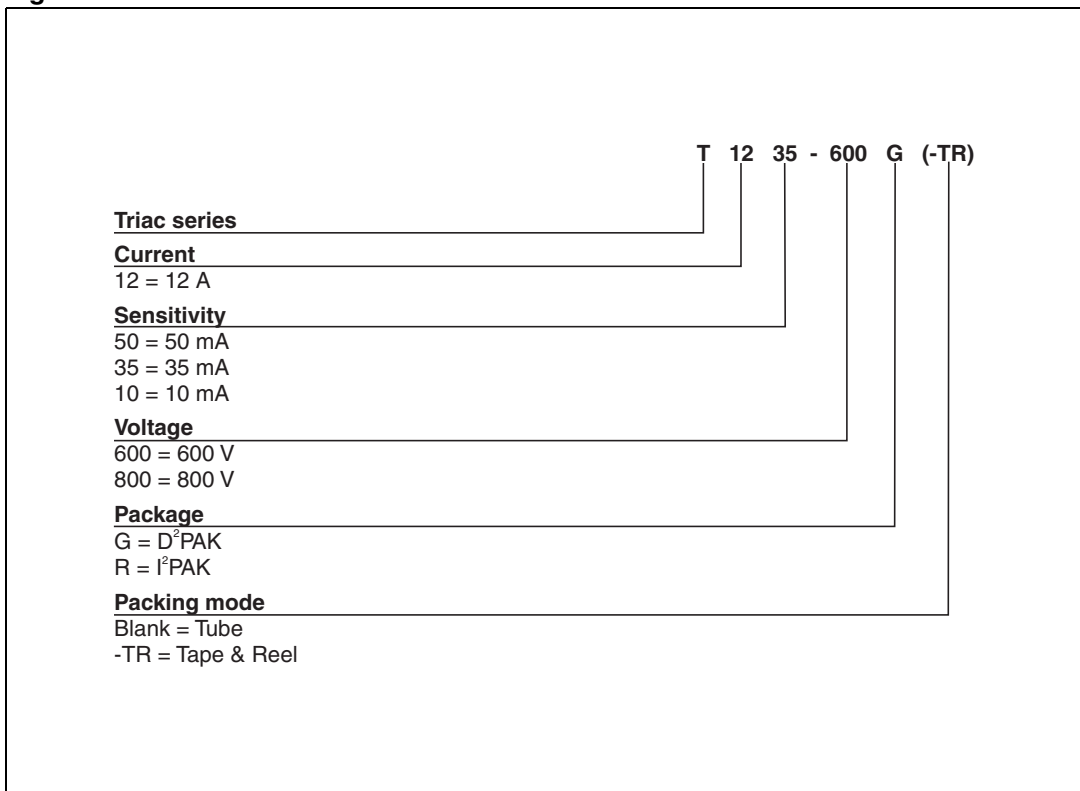

Table 7. Product selector

Order code <sup>(1)</sup>	Voltage (xxx)		Sensitivity	Type	Package
	600 V	800 V			
BTA/BTB12-xxxBRG	X	X	50 mA	Standard	TO-220AB
BTA/BTB12-xxxBWRG	X	X	50 mA	Snubberless	TO-220AB
BTA/BTB12-xxxCRG	X	X	25 mA	Standard	TO-220AB
BTA/BTB12-xxxCWRG	X	X	35 mA	Snubberless	TO-220AB
BTA/BTB12-xxxSWRG	X	X	10 mA	Logic Level	TO-220AB
BTA/BTB12-xxxTWRG	X	X	5 mA	Logic Level	TO-220AB
T1210-800G	-	X	10 mA	Logic Level	D <sup>2</sup> PAK
T1235-xxxG	X	X	35 mA	Snubberless	D <sup>2</sup> PAK
T1235-xxxR	X	X	35 mA	Snubberless	I <sup>2</sup> PAK
T1250-600G	X	-	50 mA	Snubberless	D <sup>2</sup> PAK

1. **BTB**: non insulated TO-220AB package



### 3 Packaging information

- Epoxy meets UL94, V0

In order to meet environmental requirements, ST offers these devices in ECOPACK® packages. These packages have a lead-free second level interconnect. The category of second level interconnect is marked on the package and on the inner box label, in compliance with JEDEC Standard JESD97. The maximum ratings related to soldering conditions are also marked on the inner box label. ECOPACK is an ST trademark. ECOPACK specifications are available at: [www.st.com](http://www.st.com).

**Table 8. D<sup>2</sup>PAK dimensions**

Ref.	Dimensions					
	Millimeters			Inches		
	Min.	Typ.	Max.	Min.	Typ.	Max.
A	4.30		4.60	0.169		0.181
A1	2.49		2.69	0.098		0.106
A2	0.03		0.23	0.001		0.009
B	0.70		0.93	0.027		0.037
B2	1.25	1.40		0.048	0.055	
C	0.45		0.60	0.017		0.024
C2	1.21		1.36	0.047		0.054
D	8.95		9.35	0.352		0.368
E	10.00		10.28	0.393		0.405
G	4.88		5.28	0.192		0.208
L	15.00		15.85	0.590		0.624
L2	1.27		1.40	0.050		0.055
L3	1.40		1.75	0.055		0.069
R	0.40			0.016		
V2	0°		8°	0°		8°

**Figure 15. Footprint (dimensions in mm)**

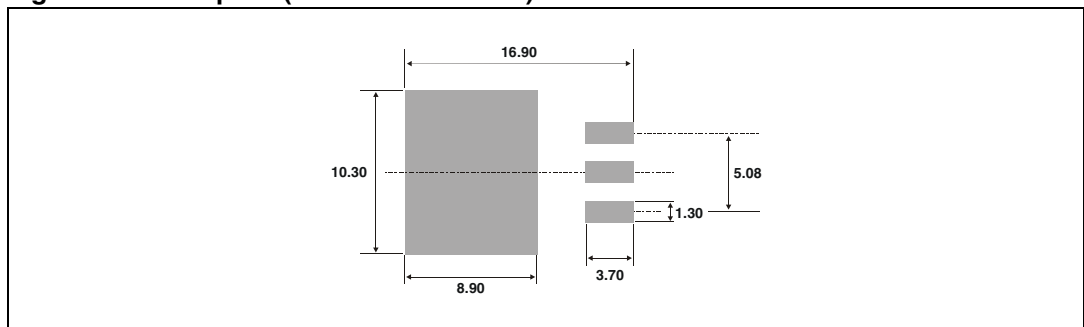
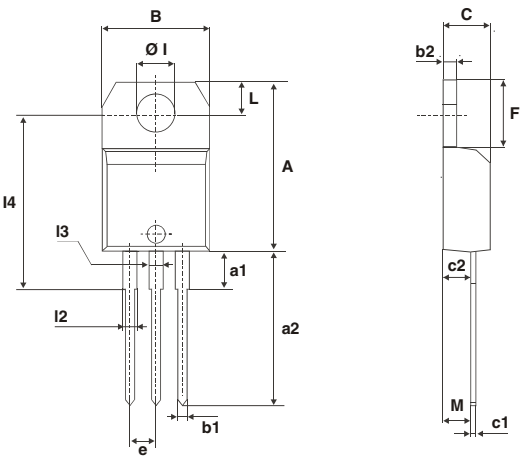

Table 9. I<sup>2</sup>PAK dimensions

Ref.	Dimensions					
	Millimeters			Inches		
	Min.	Typ.	Max.	Min.	Typ.	Max.
A	4.30		4.60	0.169		0.181
A1	2.49		2.69	0.098		0.106
b	0.70		0.93	0.028		0.037
b1	1.20		1.38	0.047		0.054
b2	1.25	1.40		0.049	0.055	
c	0.45		0.60	0.018		0.024
c2	1.21		1.36	0.048		0.054
D	8.95		9.35	0.352		0.368
e	2.44		2.64	0.096		0.104
E	10.00		10.28	0.394		0.405
L	13.10		13.60	0.516		0.535
L1		3.75			0.148	
L2	1.27		1.40	0.050		0.055
V		5°			5°	
V4		45°			45°	

Table 10. TO-220AB dimensions (insulated and non-insulated)



Ref.	Dimensions					
	Millimeters			Inches		
	Min.	Typ.	Max.	Min.	Typ.	Max.
A	15.20		15.90	0.598		0.625
a1		3.75			0.147	
a2	13.00		14.00	0.511		0.551
B	10.00		10.40	0.393		0.409
b1	0.61		0.88	0.024		0.034
b2	1.23		1.32	0.048		0.051
C	4.40		4.60	0.173		0.181
c1	0.49		0.70	0.019		0.027
c2	2.40		2.72	0.094		0.107
e	2.40		2.70	0.094		0.106
F	6.20		6.60	0.244		0.259
ØI	3.75		3.85	0.147		0.151
I4	15.80	16.40	16.80	0.622	0.646	0.661
L	2.65		2.95	0.104		0.116
I2	1.14		1.70	0.044		0.066
I3	1.14		1.70	0.044		0.066
M		2.60			0.102	

## 4 Ordering information

Table 11. Ordering information

Order code	Marking	Package	Weight	Base qty	Delivery mode
BTA/BTB12-xxxzyRG	BTA/BTB12-xxxzyz	TO-220AB	2.3 g	50	Tube
T1210-xxxG-TR	T1210-xxxG	D <sup>2</sup> PAK	1.5 g	1000	Tape and reel
T1235-xxxG	T1235xxxG	D <sup>2</sup> PAK	1.5 g	50	Tube
T1235-xxxG-TR	T1235xxxG			1000	Tape and reel
T1235-xxxR	T1235-xxxR	I <sup>2</sup> PAK	1.5 g	50	Tube
T1250-xxxG-TR	T1250xxxG	D <sup>2</sup> PAK	1.5 g	1000	Tape and reel

Note: xxx = voltage, y = sensitivity, z = type

## 5 Revision history

Table 12. Revision history

Date	Revision	Changes
Sep-2002	6A	Last update.
25-Mar-2005	7	1. I <sup>2</sup> PAK package added. 2. TO-220AB delivery mode changed from bulk to tube.
27-May-2005	8	T1210 added
28-Sep-2007	9	Reformatted to current standards. T1250 added

**Please Read Carefully:**

Information in this document is provided solely in connection with ST products. STMicroelectronics NV and its subsidiaries ("ST") reserve the right to make changes, corrections, modifications or improvements, to this document, and the products and services described herein at any time, without notice.

All ST products are sold pursuant to ST's terms and conditions of sale.

Purchasers are solely responsible for the choice, selection and use of the ST products and services described herein, and ST assumes no liability whatsoever relating to the choice, selection or use of the ST products and services described herein.

No license, express or implied, by estoppel or otherwise, to any intellectual property rights is granted under this document. If any part of this document refers to any third party products or services it shall not be deemed a license grant by ST for the use of such third party products or services, or any intellectual property contained therein or considered as a warranty covering the use in any manner whatsoever of such third party products or services or any intellectual property contained therein.

**UNLESS OTHERWISE SET FORTH IN ST'S TERMS AND CONDITIONS OF SALE ST DISCLAIMS ANY EXPRESS OR IMPLIED WARRANTY WITH RESPECT TO THE USE AND/OR SALE OF ST PRODUCTS INCLUDING WITHOUT LIMITATION IMPLIED WARRANTIES OF MERCHANTABILITY, FITNESS FOR A PARTICULAR PURPOSE (AND THEIR EQUIVALENTS UNDER THE LAWS OF ANY JURISDICTION), OR INFRINGEMENT OF ANY PATENT, COPYRIGHT OR OTHER INTELLECTUAL PROPERTY RIGHT.**

**UNLESS EXPRESSLY APPROVED IN WRITING BY AN AUTHORIZED ST REPRESENTATIVE, ST PRODUCTS ARE NOT RECOMMENDED, AUTHORIZED OR WARRANTED FOR USE IN MILITARY, AIR CRAFT, SPACE, LIFE SAVING, OR LIFE SUSTAINING APPLICATIONS, NOR IN PRODUCTS OR SYSTEMS WHERE FAILURE OR MALFUNCTION MAY RESULT IN PERSONAL INJURY, DEATH, OR SEVERE PROPERTY OR ENVIRONMENTAL DAMAGE. ST PRODUCTS WHICH ARE NOT SPECIFIED AS "AUTOMOTIVE GRADE" MAY ONLY BE USED IN AUTOMOTIVE APPLICATIONS AT USER'S OWN RISK.**

Resale of ST products with provisions different from the statements and/or technical features set forth in this document shall immediately void any warranty granted by ST for the ST product or service described herein and shall not create or extend in any manner whatsoever, any liability of ST.

ST and the ST logo are trademarks or registered trademarks of ST in various countries.

Information in this document supersedes and replaces all information previously supplied.

The ST logo is a registered trademark of STMicroelectronics. All other names are the property of their respective owners.

© 2007 STMicroelectronics - All rights reserved

STMicroelectronics group of companies

Australia - Belgium - Brazil - Canada - China - Czech Republic - Finland - France - Germany - Hong Kong - India - Israel - Italy - Japan - Malaysia - Malta - Morocco - Singapore - Spain - Sweden - Switzerland - United Kingdom - United States of America

[www.st.com](http://www.st.com)