



HESTORE.HU

elektronikai alkatrész áruház

EN: This Datasheet is presented by the manufacturer.

Please visit our website for pricing and availability at www.hestore.hu.

Metal Oxide Film Leaded Resistor – MOF Series

Construction

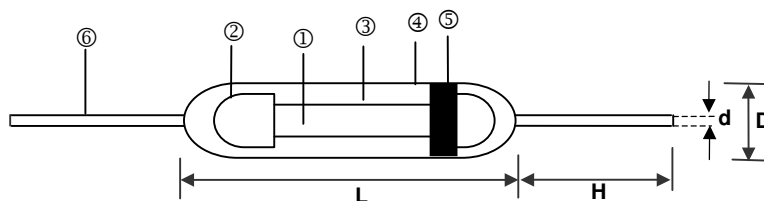
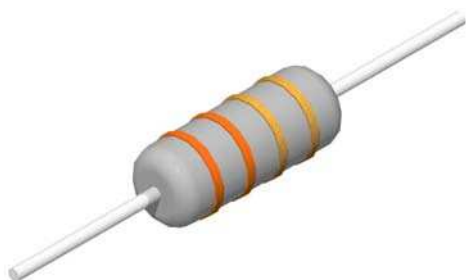

① Ceramic Rod	④ Non-flame Paint With Sol Vent-proof
② Tinned Iron Caps	⑤ Color Code
③ Metal Outside	⑥ Lead Wire

Features

- Excellent Long-Time stability
- High surge / overload capability
- Wide resistance range: 0.1Ω~10MΩ
- Controlled temperature coefficient
- Resistance standard tolerance: ±5% (consult factory for ±2% ±1%)
- Electrical and mechanical stability and high reliability

Dimensions

Unit: mm

Type	L	D	H	d	Weight (g) (1000pcs)
MOF0623	6.3±0.5	2.3±0.3	28±2.0	0.55±0.03	156
MOF0932	9.0±0.5	3.2±0.5	26±2.0	0.65±0.03	355
MOF1145	11.5±1.0	4.5±0.5	35±2.0	0.78±0.03	760
MOF1550	15.5±1.0	5.0±0.5	32±2.0	0.78±0.03	1040

Applications

- Automotive
- Telecommunication
- Medical Equipment

Derating Curve

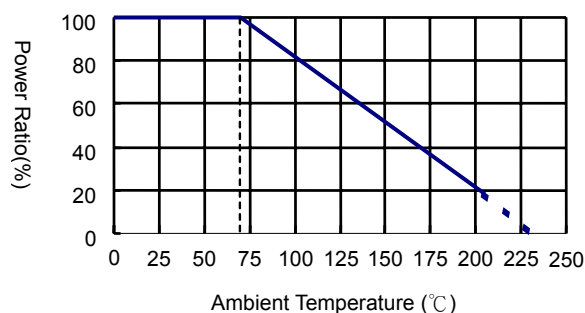

Part Numbering

MOF	0623	F	A	F	U	1001	MA
Product Type	Dimensions (L×D)	Resistance Tolerance	Packaging Code	TCR (PPM/°C)	Power Rating	Resistance	Special
	0623: 6.3x2.3 0932: 9.0x3.2 1145: 11.5x4.5 1550: 15.5x5.0	F: ±1% G: ±2% J: ±5%	A: Ammo B: Bulk T: Taping Reel	F: ±200	: Standard R: 3W S: 2W T: 1W U: 1/2W	R500: 0.5Ω 0010: 1Ω 1000: 100Ω 2201: 2200Ω 1001: 1KΩ 1004: 1MΩ	: Standard MA: MA-type MB: MB-type MC: MC-type FA: FA-type FB: FB-type FC: FC-type PA: PA-type PB: PB-type

Standard Electrical Specifications

Item Type	Power Rating at 70°C	Operating Temp. Range	Max. Working Voltage	Max. Overload Voltage	Dielectric Withstanding Voltage	Resistance Range			TCR (PPM/°C)
						±1%	±2%	±5%	
0623	1/4W	-55 ~ +155°C	200V	350V	350V	0.1Ω - 10MΩ		0.1Ω-22MΩ	±200
0932	1/2W		250V	400V	350V	0.1Ω - 1MΩ	0.1Ω - 10MΩ		
1145	1W		500V	600V	500V	0.1Ω - 1MΩ		0.1Ω - 10MΩ	
1550	2W		550V	600V	500V	0.1Ω - 1MΩ	0.1Ω - 10MΩ		

High Power Rating Electrical Specifications

Item Type	Power Rating at 70°C	Operating Temp. Range	Max. Working Voltage	Max. Overload Voltage	Dielectric Withstanding Voltage	Resistance Range			TCR (PPM/°C)
						±1%	±2%	±5%	
0623	1/2W	-55 ~ +155°C	250V	400V	350V	0.1Ω - 10MΩ			±200
0932	1W		300V	500V	400V	0.1Ω - 1MΩ	0.1Ω - 10MΩ		
1145	2W		500V	600V	500V	0.1Ω - 1MΩ		0.1Ω - 10MΩ	
1550	3W		750V	700V	600V	0.1Ω - 1MΩ	0.1Ω - 10MΩ		

■ Resistor body color: Standard Power Rating: Grey High Power Rating: Pink

Environmental Characteristics

Item	Requirement	Test Method
Short Time Overload	±(0.25%+0.05Ω)	RCWV*2.5 or Max. overload voltage for 5 seconds
Insulation Resistance	> 1000MΩ	Apply 100V _{DC} for 1 minute
Endurance	±(1.5%+0.05Ω)	70±2°C, Max. working voltage for 1000 hrs with 1.5 hrs "ON" and 0.5 hrs "OFF"
Damp Heat with Load	±(1.5%+0.05Ω)	40±2°C, 90~95% R.H. Max. working voltage for 1000 hrs with 1.5 hrs "ON" and 0.5 hrs "OFF"
Solderability	90% min. Coverage	245±5°C for 3 seconds
Dielectric Withstanding Voltage	By Type	Apply Max. Overload Voltage for 1 minute
Temperature Coefficient	By Type	Resistance value at room temperature and room temperature+100°C
Pulse Overload	±(1%+0.05Ω)	4 times RCWV for 10000 cycles with 1second "ON" and 25 seconds "OFF"
Resistance To Solvent	No deterioration of coatings and markings	Trichroethane for 1 min. with ultrasonic
Terminal Strength	Tensile: ≥ 2.5kg	Direct Load for 10 seconds In the direction off the terminal leads

■ Reference Standards: JIS-C 5201-1

■ Storage Temperature: 25±3°C; Humidity < 80%RH

■ Marking & Resistance Tolerance

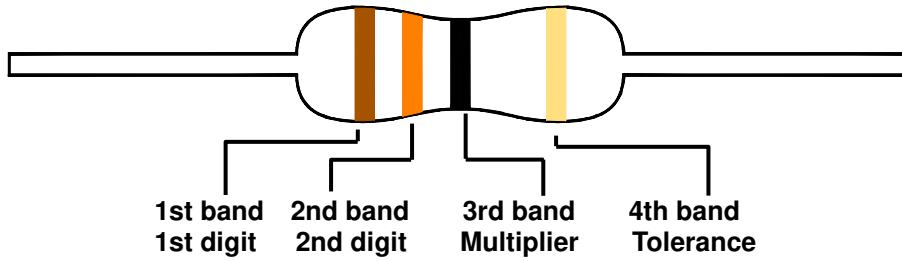

±5.00%	E-24	1.0	1.1	1.2	1.3	1.5	1.6	1.8	2.0	2.2	2.4	2.7	3.0	3.3	3.6	3.9	4.3	4.7	5.1	5.6	6.2	6.8	7.5	8.2	9.1
±2.00%																									

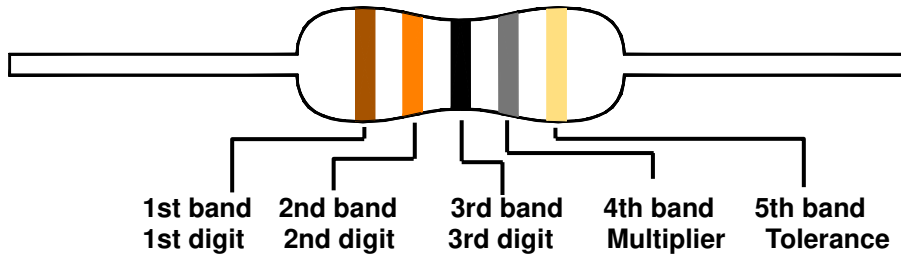

±1.00%	E-96	1.00	1.02	1.05	1.07	1.10	1.13	1.15	1.18	1.21	1.24	1.27	1.30	1.33	1.37	1.40	1.43	1.47	1.50	1.54	1.58	1.62	1.65	1.69	1.74
		1.78	1.82	1.87	1.91	1.96	2.00	2.05	2.10	2.15	2.21	2.26	2.32	2.37	2.43	2.49	2.55	2.61	2.67	2.74	2.80	2.87	2.94	3.01	3.09
		3.16	3.24	3.32	3.40	3.48	3.57	3.65	3.74	3.83	3.92	4.02	4.12	4.22	4.32	4.42	4.53	4.64	4.75	4.87	4.99	5.11	5.23	5.36	5.49
		5.62	5.76	5.90	6.04	6.19	6.34	6.49	6.65	6.81	6.98	7.15	7.32	7.50	7.68	7.87	8.06	8.25	8.45	8.66	8.87	9.09	9.31	9.53	9.76

Color	Digit	Multiplier	Tolerance	
Without	-	-	±20%	M
Silver	-	10 ⁻²	±10%	K
Gold	-	10 ⁻¹	±5%	J
Black	0	10 ⁰	-	-
Brown	1	10 ¹	±1%	F
Red	2	10 ²	±2%	G
Orange	3	10 ³	-	-
Yellow	4	10 ⁴	-	-
Green	5	10 ⁵	±0.5%	D
Blue	6	10 ⁶	±0.25%	C
Violet	7	10 ⁷	±0.1%	B
Grey	8	10 ⁸	±0.05%	A
White	9	10 ⁹	-	-

■ Taping/Packing Specifications

1. Standard Type (Reel & Ammo)

Packing Methods

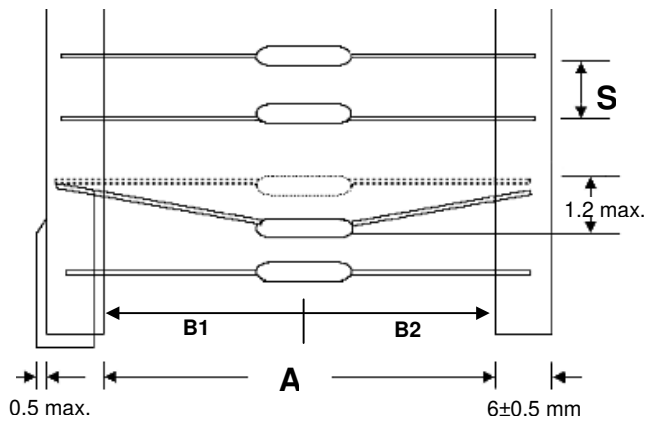

Reel Packing

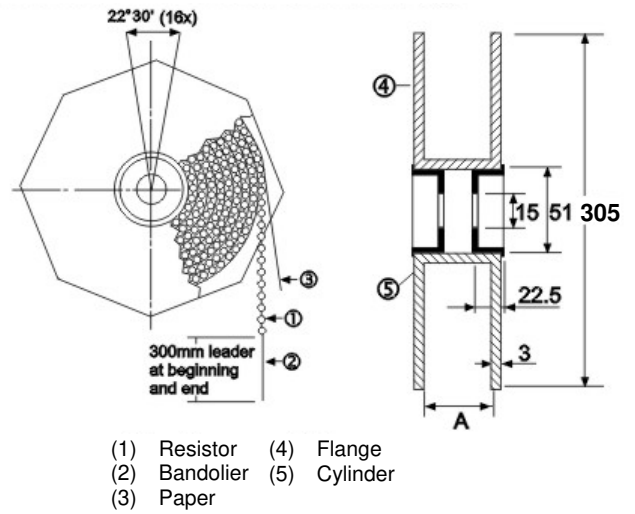

Unit: mm

Type	Packing Methods			Reel Packing	
	A	B1-B2	S	Across Flange (A)	Qty
0623	52+1/-0	1.2	5	72	5,000
0932	52+1/-0	1.2	5	72	2,500
1145	52+1/-0	1.5	5	95	2,000
1550	52+1/-0	1.5	10	95	1,000

Ammo Packing

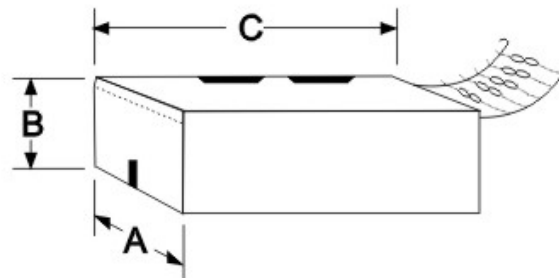

Unit: mm

Type	Packing Methods			Ammo Packing			
	A	B1-B2	S	A	B	C	Qty
0623	26+1/-0	1.0	5	80	105	264	5,000
0932	52+1/-0	1.2	5	80	46	264	1,000
1145	73+1/-0	1.5	5	103	82	265	1,000
1550	73+1/-0	1.5	10	103	96	265	1,000

2. Special Type (Bulk)

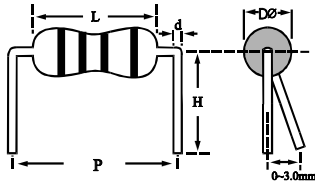

MA Type

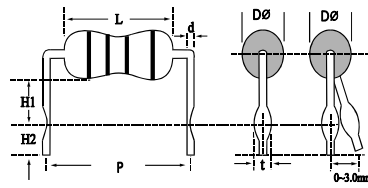

MB Type

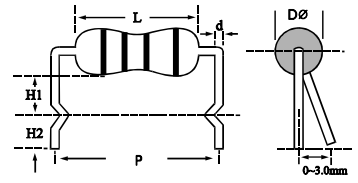

MC Type

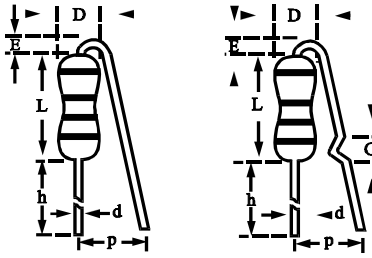

FA Type

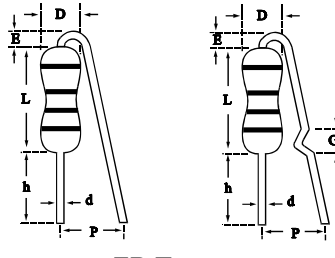

FB Type

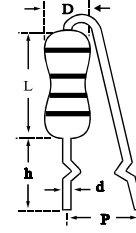

FC Type

Unit: mm

Product Type	Type	P	H /H1/h	H2/G	t	D	L	d	E
0623	MA	10.0±1	10.0±1	-	-	2.3±0.3	6.30±0.5	0.55±0.03	-
	FA	10.0±1	28.0±2	2.00±0.5	-	2.3±0.3	6.30±0.5	0.55±0.03	2.00±0.5
	FB	10.0±1	8.00±1	2.00±0.5	-	2.3±0.3	6.30±0.5	0.55±0.03	2.00±0.5
0932	MA	12.5±1	10.0±1	-	-	3.2±0.5	9.00±0.5	0.65±0.03	-
	FC	6.00±1	10.0±1	-	-	3.2±0.5	9.00±0.5	0.65±0.03	-
1145	MA	15.0±1	12.5±1	-	-	4.5±0.5	11.5±1.0	0.78±0.03	-
	MB	15.0±1	6.00±1	5.00±1.0	1.4±0.2	4.5±0.5	11.5±1.0	0.78±0.03	-
	MC	15.0±1	6.00±1	5.00±1.0	-	4.5±0.5	11.5±1.0	0.78±0.03	-
	FC	6.00±1	10.0±1	-	-	4.5±0.5	11.5±1.0	0.78±0.03	-
1550	MA	20.0±1	15.0±1	-	-	5.0±0.5	15.5±1.0	0.78±0.03	-
	MB	20.0±1	10.0±1	5.00±1.0	1.4±0.2	5.0±0.5	15.5±1.0	0.78±0.03	-
	MC	20.0±1	10.0±1	5.00±1.0	-	5.0±0.5	15.5±1.0	0.78±0.03	-
	FC	6.00±1	10.0±1	-	-	5.0±0.5	15.5±1.0	0.78±0.03	-

3.Special Type (Reel & Ammo)

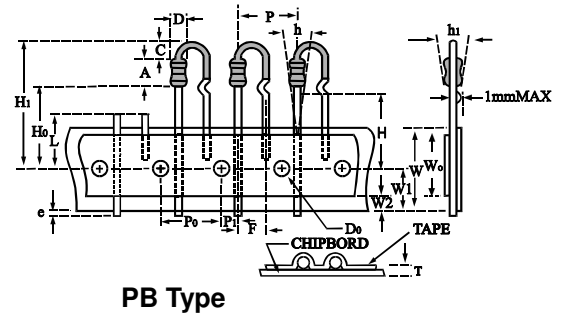
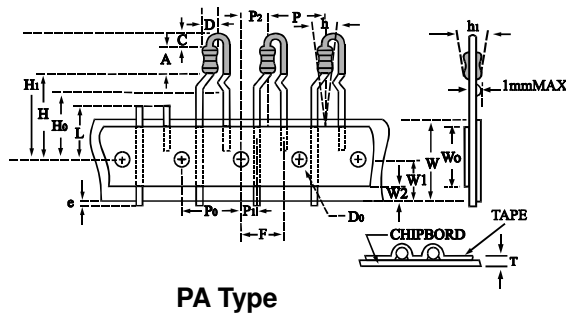

Packing Specification

Unit: mm

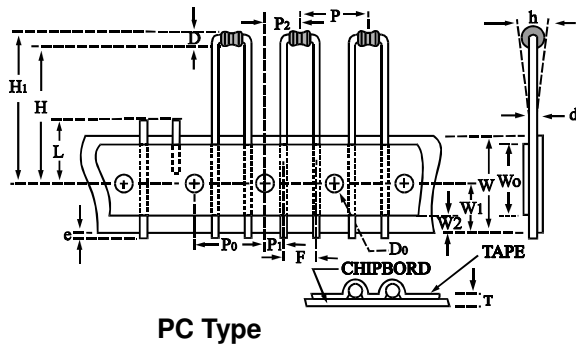

Dimension	AMMO			REEL				
	A	B	C	A	B	C	W1	W2
	53	120	325	31	76	312	44	50
Qty: EA	2,000 / 3,000			2,500 / 3,000				

Unit: mm

Dimension	PA type	PB type
	0623	0623
D	2.3±0.2	2.3±0.2
A	6.5±0.5	6.5±0.5
P	12.7±1.0	12.7±1.0
PO	12.7±0.3	12.7±0.3
P1	3.85±0.7	3.85±0.7
P2	6.35±1.0	6.35±1.3
F	5.0±1.0	5.0+0.8/-0.2
h	0±2.0 (0±5°)	0±2.0 (0±5°)
W	18±1.0/-0.5	18.0±1.0/-0.5
Wo	12.5 min.	15.0±1.0
W1	9.0+0.75/-0.5	9.0+0.75/-0.5
W2	3.0 max.	2.75 max.
H	19.0±1.0	16.0±1.0/-0.3
HO	16.0±0.5	16.0±0.5
e	2.0 max.	1.0 max.
DO	4.0±0.3	4.0±0.3
T	0.7±0.2	0.7±0.2
L	11.0 max.	2.0 max.
H1	28.5 max.	27 max.
C	2.5±0.5	3.0+0/-0.039
h1 / d	0±2.0 (0±5°)	0±2.0 (0±5°)

■ Cumulative Pitch Tolerances Not to Exceed±1.0mm (±0.039 In) over 20 consecutive pitches