



HESTORE.HU

elektronikai alkatrész áruház

EN: This Datasheet is presented by the manufacturer.

Please visit our website for pricing and availability at www.hestore.hu.

SRD Series SUBMINATURE HIGH POWER RELAY 7A/10A/15A



R50056114
R50137084



CQC08002027667

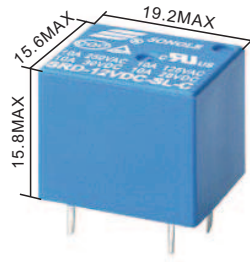

Features

- Miniature volume, PCB usage
- Contact rating: 7A/10A/15A
- Temperature range: +85°C/+105°C

Ordering Information

SRD-12VDC-S L-C

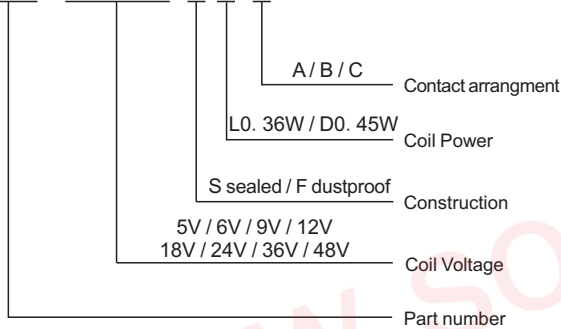

Contact Rating

Contact arrangement	1A(spstno)/1B(Spstnc)/1C(Spdt)
Contact resistance	100mΩ (1A 6VDC)
Contact material	Silver alloy: AgCdO、AgSnO ₂ 、AgNi
Contact rating	7A/250VAC 10A/250VAC 15A/250VAC
Max switching voltage	250VAC
Max switching current	15A
Max switching power	3750VA
Electrical endurance (frequency: 1800 ops/h)	1x10 ⁵ ops / 1x10 ⁴ ops
Mechanical endurance (frequency: 18000 ops/h)	1x10 ⁷ ops

Characteristics

Insulation system	Class B / Class F	
Insulation resistance	100MΩ (500VDC)	
Dielectric Strength	Between contacts and coil	1500VAC 1 minute
	Between open contacts	1000VAC 1 minute
Leakage current 1mA		
Operate time(Under nominal voltage)	≤10ms	
Release time(Under nominal voltage)	≤10ms	
Humidity	85% RH (20°C)	
Ambient Temperature	-40°C~+85°C/-40°C~+105°C	
Shock resistance	Functional	98m/s ²
	Destructive	980m/s ²
Vibration resistance (Double amplitude)	10Hz~55Hz 1.5mm	
Weight	Approx 9g	
Construction	Sealed	

Remark:1)All above data is initial value

Coil Data

(at 20°C)

Power dissipation W	Voltage VDC	Current mA	Resistance Ω±10%	Pick-up voltage	Drop-out voltage	Max allowable
0.36W (L)	05	71.4	70	75%Max	10%Min	130%
	06	60	100			
	09	40	225			
	12	30	400			
	18	20	900			
	24	15	1600			
	36	10	3600			
	48	7.5	6400			
0.45W (D)	05	89.3	55	75%Max	10%Min	130%
	06	75	80			
	09	50	180			
	12	37.5	320			
	18	25	720			
	24	18.7	1280			
	36	12.5	2880			
	48	10	4500			

This product specification only for your reference, we will not notify you if we do any improvement. We reserve all the right for the final explanation





Web: www.songle.com www.songlerelay.com

Add.: CW7, Zone A, Far East Industrial Park, Yuyao City, Zhejiang, China Zip Code: 315400

SRD Series SUBMINATURE HIGH POWER RELAY 7A/10A/15A

Safety Approval Ratings

 CQC08002027667
7A 250VAC 10A 250VAC

 R50056114 R50137084
7A 250VAC 10A 250VAC 15A 250VAC NO

 US E167996
3A 125VAC inductive 10A 125VAC 15A 125VAC NO

OUTLINE DIMENSIONS ,WIRING DIAGRAM AND PC BOARD LAYOUT Unit:mm

Physical installation diagram

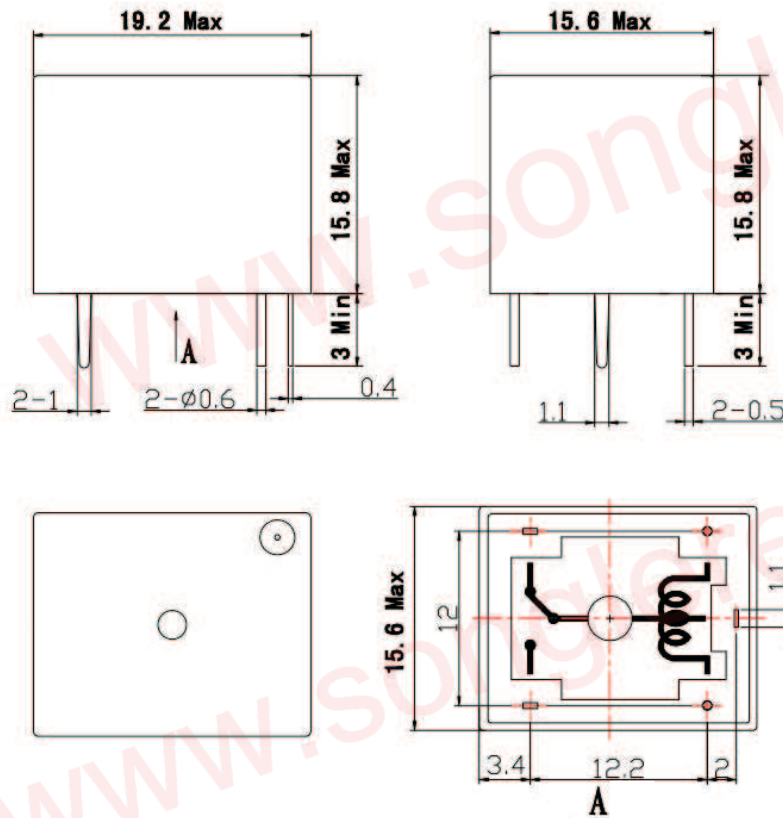

Tolerance: ± 0.1 mm

PCB board diagram (bottom view diagram)

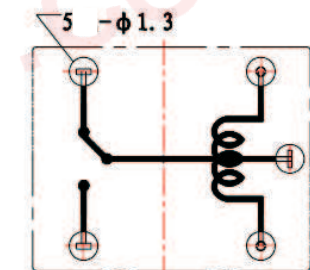

Conversion C type

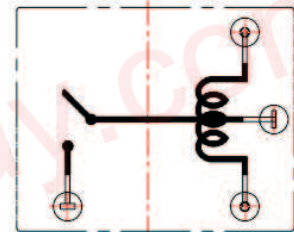

Normally open A type

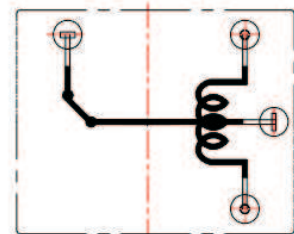

Normally closed B type

(Bottom view)

This product specification only for your reference. we will not notify you if we do any improvement. We reserve all the right for the final explanation



Web: www.songle.com www.songlerelay.com

Add.: CW7, Zone A, Far East Industrial Park, Yuyao City, Zhejiang, China Zip Code: 315400