



**HESTORE.HU**

elektronikai alkatrész áruház

**EN:** This Datasheet is presented by the manufacturer.

Please visit our website for pricing and availability at [www.hestore.hu](http://www.hestore.hu).

# CA9

Carbon Potentiometers CA

# CE9

Cermet Potentiometers CE



## CARBON – CA9

9mm carbon potentiometers with plastic housing and Ingress Protection rating type IP 54 (high level of protection against dust and also against water splashing), according to IEC 60529. Plastic materials can be self-extinguishable according to UL 94 V-0 under request.

Through-hole and SMD configurations are available. Terminals and collector are normally manufactured in tinned brass, although versions with steel terminals are also available under request. Terminals for through-hole models can be provided straight or crimped, which helps hold the component to the PCB during soldering.

Tapers can be linear, log and antilog; special tapers can also be studied.

ACP's potentiometers can be adjusted from either the front or the back, both in the horizontal and the vertical adjustment types. Thumbwheels and shafts can be ordered either separately or already inserted in the potentiometer.

Potentiometers can be manufactured in a wide range of possibilities regarding:

- Resistance value.
- Tolerance.
- Tapers / variation laws.
- Pitch.
- Positioning of the wiper (standard is at 50% rotation).
- Housing and rotor color.
- Mechanical life.
- Click effect (up to 20 detents available).
- Self-extinguishable plastic parts according to UL 94 V-0.

### Applications

9mm potentiometers are mainly used in control applications, in different markets:

- Industrial: Timers and relays, dimmers, adjustment of output.
- Electronic appliances: volume regulation, temperature controls and function selection.
- Automotive: Lighting regulation (position adjustment and sensing for headlights), dimmers, seat heating controls.

## CERMET – CE9

9mm cermet potentiometers with plastic housing and Ingress Protection rating type IP 54 (high level of protection against dust and also against water splashing), according to IEC 60529. Plastic materials (housing and rotor) are self-extinguishable according to UL 94 V-0 for ACP's cermet potentiometers.

Cermet potentiometers have better thermal stability, allow for higher thermal dissipation and withstand higher temperatures than carbon potentiometers.

Through-hole and SMD configurations are available. Terminals and collector are manufactured in tinned brass, although versions with steel terminals are also available under request. Terminals for through-hole models can be provided straight or crimped, which helps hold the component to the PCB during soldering.

Tapers can be linear, log and antilog; special tapers can also be studied.

ACP's potentiometers can be adjusted from either the front or the back, both in the horizontal and the vertical adjustment types. Thumbwheels and shafts can be ordered either separately or already inserted in the potentiometer.

Potentiometers can be manufactured in a wide range of possibilities regarding:

- Resistance value.
- Tolerance.
- Tapers / variation laws.
- Pitch.
- Positioning of the wiper (the standard is at 50%).
- Housing and rotor color.
- Mechanical life.
- Click effect (up to 20 detents available).

### Applications

9mm cermet potentiometers are used in applications where either the operating temperature is high, or where the application requires product with excellent ohmic value stability:

- Electronic appliances: temperature controls.
- Automotive: climate controls, position sensors, seat heating controls.
- Industrial electronics: multimeters, oscilloscopes, time relays, measurement and test equipment.

# CA9 CE9 HOW TO ORDER

EXAMPLE: **CA9MH2,5-10KA2020 SNP PI WT-9005-BA**

EXAMPLE: **CE9MH2,5-10KA2020 SNP PI WT-9005-BA-V0**

Standard features								Extra features							Assembled accessory			
Series	Rotor	Model	Packg.	Ohm value	Taper	Tol.	Life	Track	Detents	Snap in	Housing	Rotor	Wiper	Lin.	Assembly	Ref #	Color	Flam.
1	2	3	4	5	6	7	8	9	10	11	12	13	14	15	16			
CA9/CE9	M	H2,5		- 10K	A	2020		SNP				PI		WT	-9005	-BA	-V0	

Standard configuration:	CA9 Through-hole	CA9 SMD	CE9 Through-hole and SMD
Dimensions:		9mm	
Protection:		IP 54 (dust-proof) On request: Self-extinguishable, to meet UL 94 V-0	
Substrate:	Carbon technology	Carbon technology, special for high temperature	Cermet
Color:	Blue housing + white rotor	Brown housing + grey rotor	Brown housing + white rotor
Packaging:		Bulk	
Wiper position:		at 50% ±15°	
Terminals:		Straight, without crimping.	
Marking:		Resistive value marked on housing. Others on request.	

**Customized products:** A drawing is requested when ordering a customized product. Series, rotor, model and total resistive value are indicated before the code that includes all special specifications. Example: CA9PH2,5-10K CODE C00111.

## 1 - Series

■ CA9 ■ CE9

## 2 - Rotors

C D J K KA M MA MT P R Y

## 3 - Model and pitch

H2,5 H3,8 HS3,8 H5 HSMD V7,5  
(Under request, not readily available)

V10 VK10 VR10 MAV10 MTV10 VSMD VSMD WT-9002

## 4 - Packaging

### Trough-hole

### SMD models

Bulk	(blank) <sup>(1)</sup>	(blank) <sup>(1)</sup>
T&R (Tape and 13" reel)	(N.A.) <sup>(2)</sup>	T&R
T&R (Tape and 15" reel)	(N.A.) <sup>(2)</sup>	T&R15

(1) If blank, bulk packaging is implied. (2) N.A., Not Applicable. Tape and Reel packaging is only available for SMD terminals.

## 5 - Resistance value

100Ω 200Ω 220Ω 250Ω 470Ω 500Ω 1KΩ 2KΩ ... 500KΩ 1MΩ 2MΩ 2M2Ω 4M7Ω 5MΩ

100 200 220 250 470 500 1K 2K 500K 1M 2M 2M2 4M7 5M

## 6 - Resistance law / taper

Lin - Linear	A
Log - Logarithmic	B
Antilog - Antilogarithmic	C
- Special tapers have codes assigned:	CODE YXXXXX

## 7 - Tolerance

±20%	±30%	+50%,-30%	±10%	±5%
2020	3030	5030	1010	0505

## 8 - Operating Life (Cycles)

Standard (1.000 cycles) (leave blank)

Long life: LV + the number of cycles. ex: LV10 for 10.000 cycles. (others on request) LVXX: ex: LV10

## 9 - Cut Track – Open circuit.

Open circuit at beginning of track, fully CCW	PCI
Open circuit at end of track, fully CW	PCF

## 10 - Detents (DT)

One detent at the beginning	DTI
One detent at the end	DTF
X number of detents	XDT: 10DT

Special detents are available on request. If you need to assign a voltage value to each detent, please inquire.

## 11 - Terminals

SNAP IN P	SNP
SNAP IN J	SNJ
Shorter tip of terminal, TPXX, where XX is tip length (under request)	TPXX, ex: TP25

## 12 - Housing

**Color:** For colors other than standard: -See color chart below- CJ-color, ex., red: CJ-RO

## 13 - Rotor

**Color:** For colors other than standard: -See color chart below- RT-color; ex., blue: RT-AZ

## \* Self-extinguishable property, V0, for housing and rotor:

By default, carbon is non self-extinguishable, cermet is self-extinguishable: (blank)  
For carbon: self-extinguishable property can be added. V0 means housing and rotor are V0 if only the housing needs to be V0, then CJ-V0. CJ-V0, RT-V0  
If only rotor: RT-V0

## 14 - Wiper

<b>Wiper position</b> (Standard: 50% ± 15°)	(leave blank)
Initial or CCW	PI
Final or CW	PF
Others: following clock positions; at 3 hours: P3H	PXH, ex: P3H
<b>Wiper torque</b> (Standard: <2.5Ncm, for detents: <3.5)	(leave blank)
Low torque, < 1.5Ncm	PGB

## 15 - Linearity

Not controlled	(leave blank)
Independent linearity controlled & below x%, for example, 3%: LN3%	LNx%; ex: LN3%
Absolute linearity controlled & below x%	LAX%

## 16 - Potentiometers with assembled accessories

Assembled from terminal side	WT
Assembled from collector side	WTI
Accessory Reference	-XXXXX
See list of shafts and thumbwheels available	Example: 9010
Color of shaft or thumbwheel	-YY Example, white: BA
Non self-extinguishable.	(leave blank)
Self-extinguishable according to standard UL 94 (-V0 in box 17 modifies only the accessory, please, note.)	-V0
<b>For ordering spare accessories:</b>	
Accessory reference - color- flammability.	XXXX-YY-V0
Ex. 9010-AZ-V0 is a blue self-extinguishable 9010 thumbwheel	

## Color chart for rotor, housing and accessories

Black <sup>(1)</sup>	White	Neutral	Transp.	Red	Green	Yellow	Blue	Grey	Brown
NE	BA	IN	TA	RO	VE	AM	AZ	GS	MR

(1) black is not an option for housings.

## Rotors

Rotors are drawn in their standard positioning, 50% of rotation. Alternative delivery positioning can be requested. Accessories in this catalogue are designed for the M rotor, unless otherwise stated.

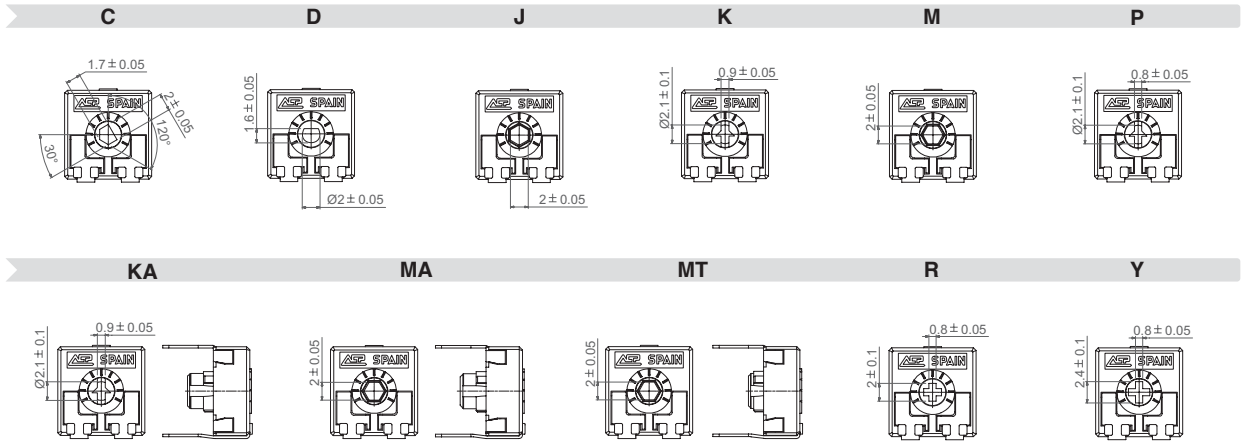

## Models

All models shown here have the most common rotor for 9mm potentiometers: the M rotor, which can be paired with any shaft or thumbwheel from this catalogue. Different rotors are available from the menu above.

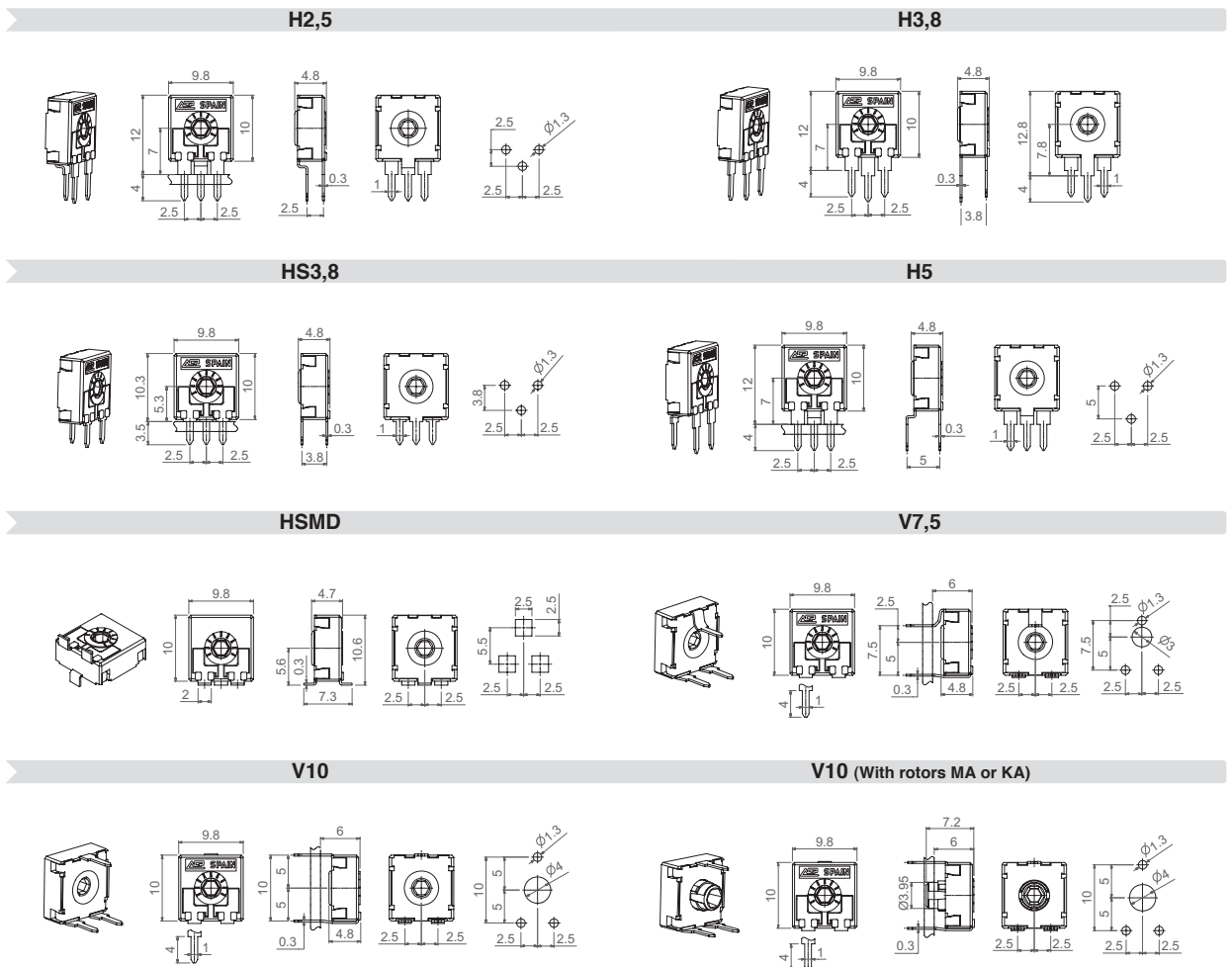

V10 (With rotor MT)

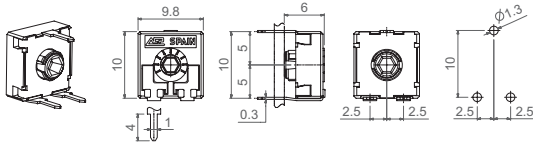

VK10

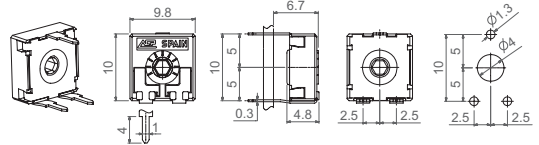

VR10

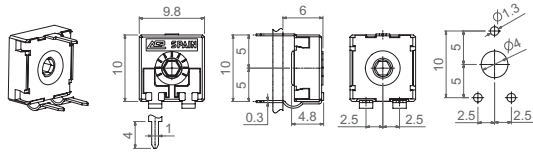

VSM D

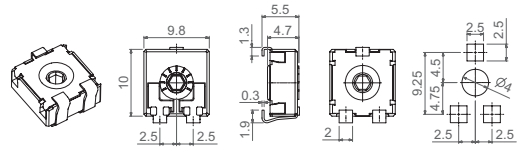

VSM D WT-9002

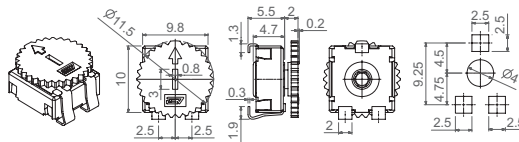

GANGED

GANGED: Set of potentiometers in a row that allows for simultaneous adjustment of all of them through one shaft. Recommended potentiometer model is H2.5. MTX2 (2 potentiometers), MTX4 (4), MTX6 (6), MTX8 (8).

Model	MTX2	MTX4	MTX6	MTX8
Shaft	9048	9039, 9051	9018	9056

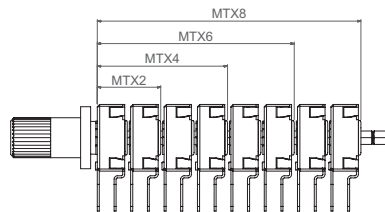

Tapers

The standard taper is linear (A). Log (B) and Antilog (C) tapers are also available, as well as special tapers according to customer's specifications. For example, a special taper can be matched with a potentiometer with detents (click effect) to guarantee a value in a specific position – see "detents" section.-

REGULAR TAPERS

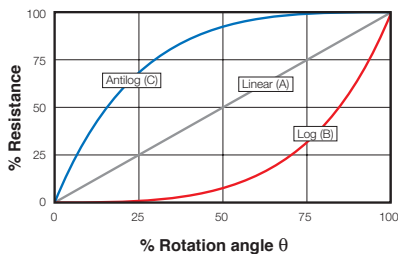

SPECIAL TAPERS

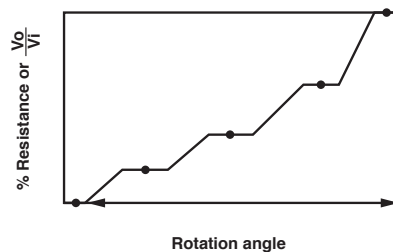

## Potentiometers with cut track

The cut track is an area with very high resistive value, resulting in an open circuit. It is widely used in lighting applications. Mechanical life with cut track needs to be confirmed.  
 PCI = Cut at initial position, when the potentiometer is turned fully counter clockwise.  
 PCF = Cut at final position, when the potentiometer is turned fully clockwise.  
 Other positions are available on request.

### PCI

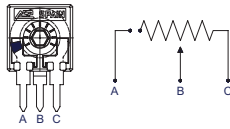

### PCF

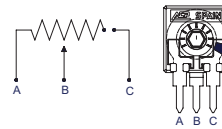

## Potentiometers with detents

ACP's patented detent (DT) feature is especially suitable for control applications where the end user will turn a knob inserted in the potentiometer. Detents can be used to add a click feeling to the turning of the potentiometer or to control the position in which the wiper is placed, assuring a particular output value with a narrow tolerance.

Detents can be light or strong, or even a combination of different feelings. They can be evenly distributed along the angle (standard) or tailored to match customers' request. They can also be combined with special tapers: constant value areas, open circuit zone, different slopes, etc. One common example is a potentiometer with detents and matching non-overlapping voltage values in specific angular positions, used to feed in a voltage value to a microprocessor:

### Example of 5DT with control of value in each DT.

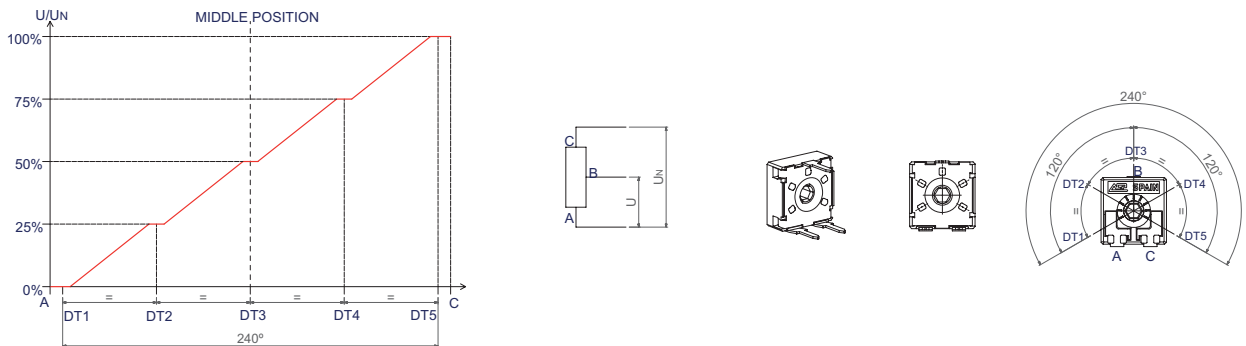

Other examples of potentiometers with detents:

### 10DT

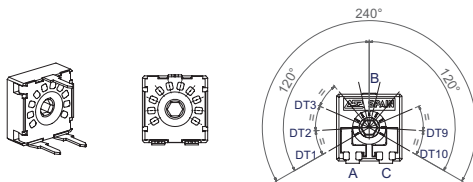

### 20DT

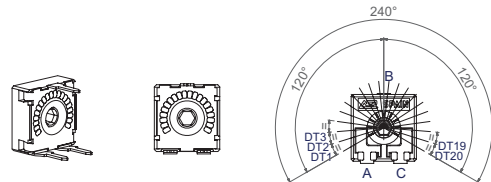

<b>Number of standard detents (evenly distributed) already available.</b>	1 (Initial, final or central), 2 DT (initial and final), 3, 4, 5, 6, 7, 8, 10, 20.
<b>Maximum number of detents for feeling only</b>	20
<b>Maximum number of detents when the voltage value in each detent is controlled and non-overlapping.</b>	10

Our patented design with two wipers has improved the performance of these potentiometers, giving them more stable electrical parameters, improved reliability and Contact Resistance Variation (CRV) as well as narrower tolerances for detent positioning.

For potentiometers with detents, mechanical life is also 1.000 cycles if no additional cycles are mentioned. Please, indicate the number of cycles needed with LV (number of cycles), for example: LV07, for 7.000 cycles.

## Terminals

By default, terminals are always straight, as shown on the “models” section. ACP can provide crimped terminals (with snap in, “SNP” or “SNJ”) to better hold the component to the PCB during the soldering operation.

### SNP

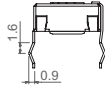

### SNJ

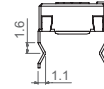

Also, there is an option of having shorter terminal tips:

### Standard Terminal

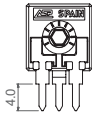

### Shorter terminal, for H5 TP25

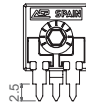

### Shorter terminal, TPXX (under request)

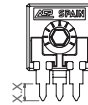

## Possibilities for insertion of accessories

Accessories can be mounted on potentiometers through either the front side (WT) or the collector side (WTI). For the specific angular position of shafts with planes, a drawing with the exact position is requested.

### WT Front side

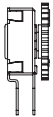

### WTI Collector side



### WT Front side

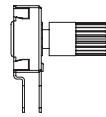

### WTI Collector side

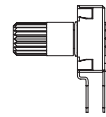

## Shafts

Shafts are available in different colors (color chart in “how to order” section) and with self-extinguishable property, according to UL 94 V-0, under request. ACP can study special shaft designs.

Shafts can be sold separately or delivered already mounted on the potentiometer at ACP.

When a shaft is mounted on a potentiometer, the distance from the top of the potentiometer to the top of the shaft is marked with “L” in the table below, as shown in the drawings:

### H potentiometer + shaft

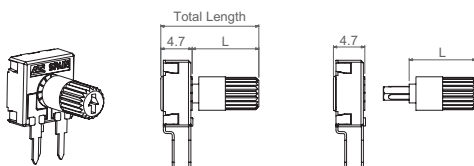

### V potentiometer + shaft

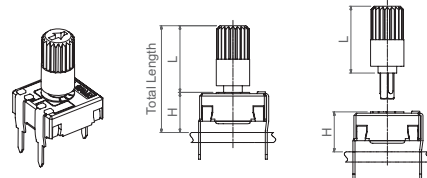

Shaft	9071	9067	9072	9074	9054	9004	9005	9064	9055	9070	9076	9053	9018	9039	9048	9056	9009	9059	9063	9010	9051	9006	9019	9073	9020	9047
L Dimension	3.5	5.5	6.5	9.3	9.5	10	10	10	10.8	11.9	12	12.1	12.8	12.8	12.8	12.8	14.5	14.5	14.5	15	15	19.7	19.9	25.5	25.9	29.8

### 9004

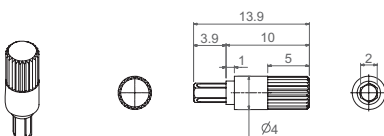

### 9005

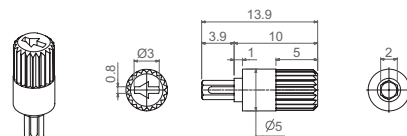



9006

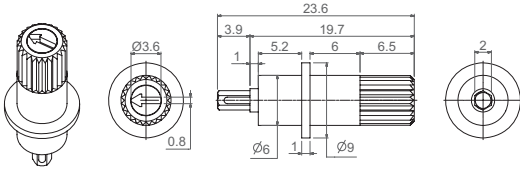

9009

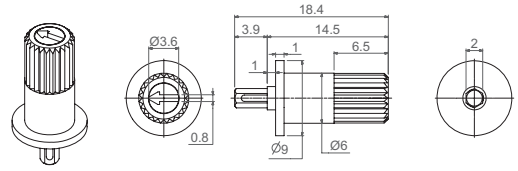

9010

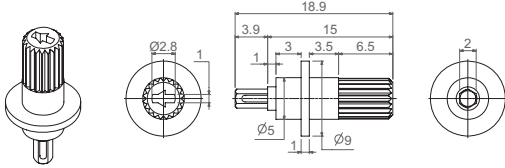

9018

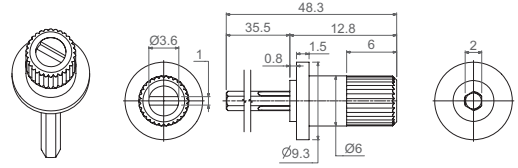

9019

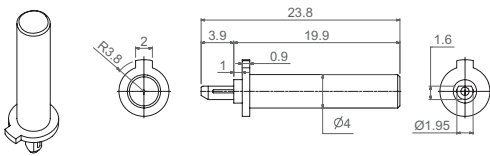

9020

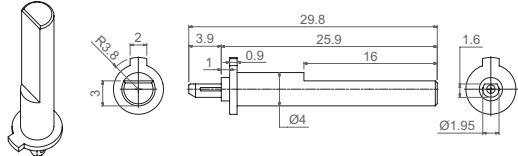

9039

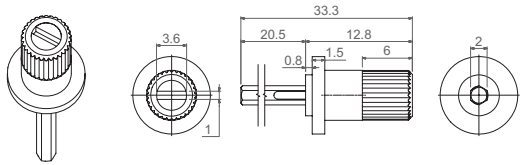

9047

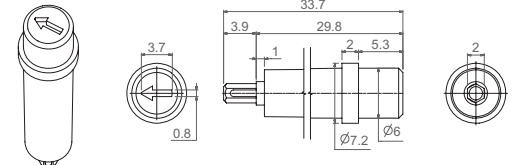

9048

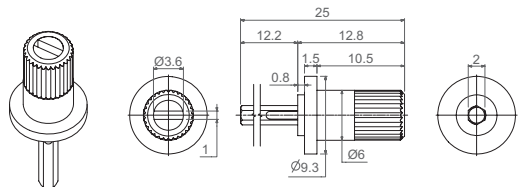

9051

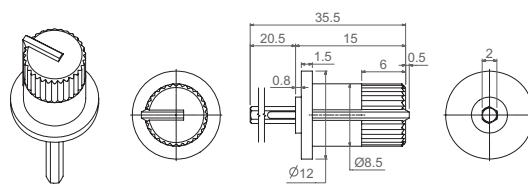

9053

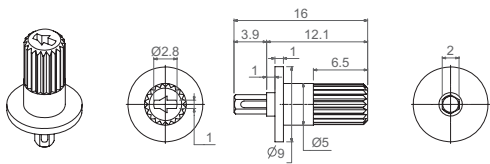

9054

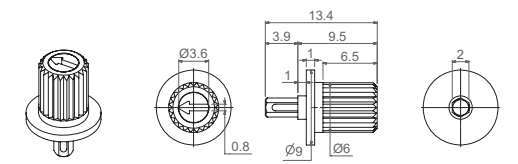

9055

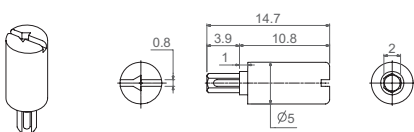

9056

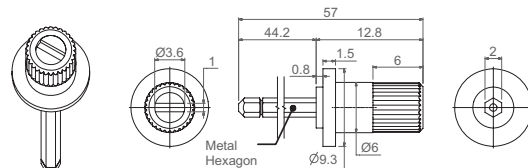

**9059**

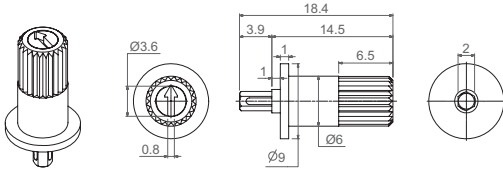

**9063**

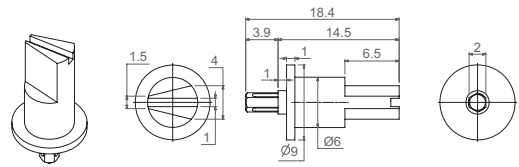

**9064**

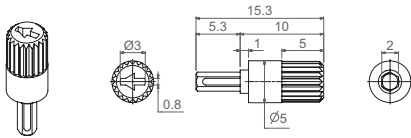

**9067**

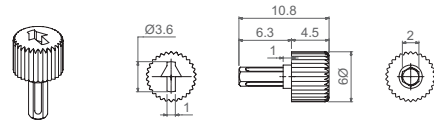

**9070**

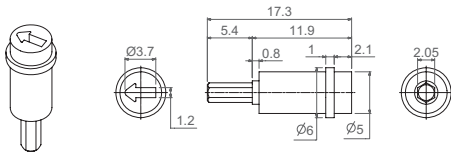

**9071**

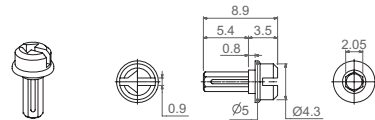

**9072**

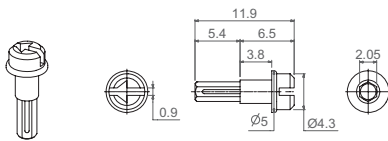

**9073**

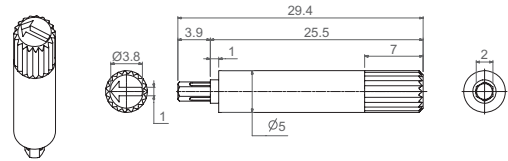

**9074**

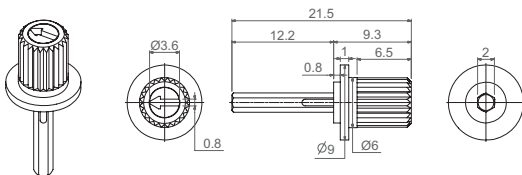

**9076**

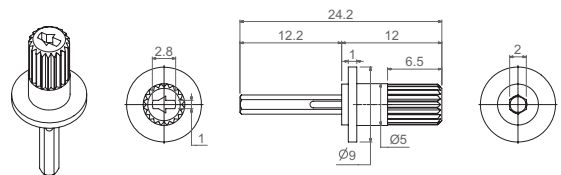

**Thumbwheel**

Thumbwheels are available in different colors (color chart in "how to order" section) and with self-extinguishable property according to UL 94 V-0, under request. Thumbwheels can be mounted on the potentiometers at ACP or sold separately. ACP can study special thumbwheel designs.

**9002**

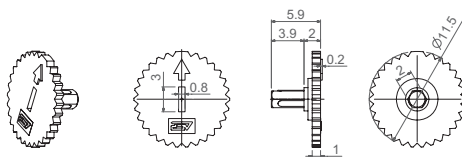

**9041**

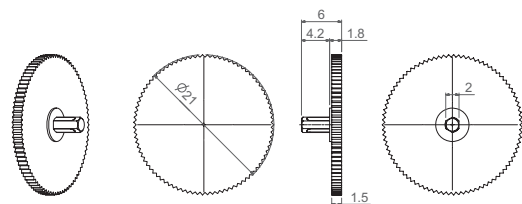

9060

9061

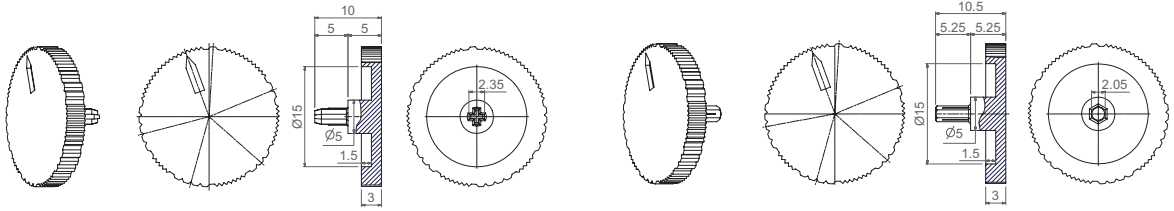

Packaging

Bulk packaging:

Potentiometer model	With shaft or thumbwheel inserted?	Pieces per small box (150 x 100 x 70)	Pieces per bigger box (250 x 150 x 70, CG on description)
H2,5 - H3,8 - H5 HS3,8 - V7,5 - V10 VK10 - VR10 - VSMD	None, only potentiometers.	500	1.500
	9002	250	1.000
	9004, 9005, 9006, 9009, 9010, 9018, 9039, 9041, 9047, 9048, 9051, 9053, 9054, 9055, 9056, 9059, 9060, 9061, 9063, 9064, 9067, 9070.	200	1.000 in general
	9071, 9072	400	1.250
MTX2	9048	150	To be determined.
MTX4	9039, 9051	75	To be determined.
MTX6	9018	50	To be determined.
MTX8	9056	40	To be determined.

Tape & Reel packaging:

	With thumbwheel inserted?	13" Reel (Standard), with 24mm width tape	15" Reel, with 24mm width tape
VSMD	None, only potentiometers.	900 pcs per reel, 12mm step between cavities.	1.250 pcs per reel, 12mm step between cavities.
	9002	700 pcs per reel, 12mm step between cavities.	To be determined.
HSMD		To be determined.	To be determined.

The 13" reel is the standard. For the 15" reel, T&R15 is added to the description.

VSMD-T&R

VSMD-T&R...WT-9002

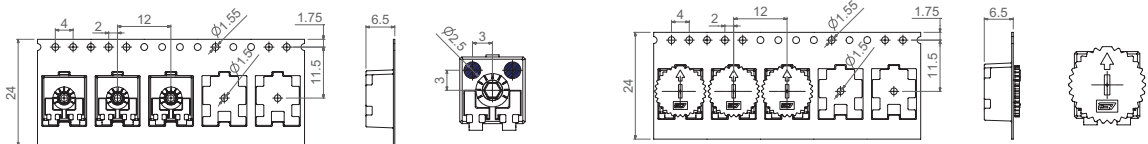

13" Reel

15" Reel

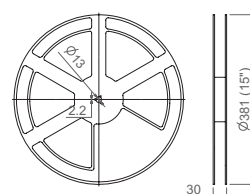
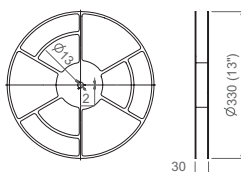

## Electric Specifications

These are standard features; other specifications and out of range values can be studied on request.

	CA9 Through-hole	CA9 SMD	CE9 Through-hole and SMD
Range of resistance values* Lin (A) Log (B) Antilog (C)	$100\Omega \leq R_n \leq 5M\Omega$ $1 K\Omega \leq R_n \leq 2M2\Omega$	$100\Omega \leq R_n \leq 1M\Omega$ $1 K\Omega \leq R_n \leq 1 M\Omega$	$100\Omega \leq R_n \leq 5M\Omega$ $1 K\Omega \leq R_n \leq 2M2\Omega$
Tolerance* Rn < 100Ω: 100Ω ≤ Rn ≤ 100KΩ: 100K < Rn ≤ 1MΩ: 1MΩ < Rn ≤ 5MΩ: Rn > 5MΩ:	+50%, -30% (out of range) ±20% ±20% ±30% +50%, -30% (out of range)	- ±30% ±40% ±50% -	- ±20% ±20% ±30% -
Variation laws	Lin (A), Log (B), Antilog (C). Other tapers available on request		
Residual resistance	Lin (A), Log (B), Antilog (C) ≤ 5*10 <sup>-3</sup> *Rn. Minimum value 2Ω		≤2Ω
CRV - Contact Resistance Variation (dynamic)	≤3%Rn		
CRV - Contact Resistance Variation (static)	≤5%Rn		
Maximum power dissipation** Lin (A) Log (B), Antilog (C)	at 50°C 0.15W 0.10W		at 70° C. 0.5W 0.20W
Maximum voltage Lin (A) Log (B), Antilog (C)	150VDC 200VDC		200VDC
Operating temperature	-25°C ... +70°C (+85°C on request)		-40°C ... +90°C (+125°C on request)
Temperature coefficient 100Ω ≤ Rn ≤ 10KΩ 10KΩ < Rn ≤ 5MΩ	+200/ -300 ppm +200/ -500 ppm	+200/ -500 ppm +200/ -1000 ppm	±100 ppm ±100 ppm

\* Out of range ohm values and tolerances are available on request, please, inquire.

\*\* Dissipation of special tapers will vary, please, inquire.

## Mechanical Specifications

	CA9 Through-hole	CA9 SMD	CE9 Through-hole and SMD
Resistive element	Carbon technology	Carbon technology	Cermet
Angle of rotation (mechanical)	240° ± 5°		
Angle of rotation (electrical)	220° ± 20°		
Wiper standard delivery position	50% ± 15°		
Max. stop torque	5 Ncm		
Max. push/pull on rotor	40 N		
Wiper torque*	<2 Ncm Potentiometers with detents: <2.5 Ncm		
Mechanical life	1.000 cycles (many more available on request, please, inquire)		

\* Stronger or softer torque feeling is available on request.

## Test results

The following typical test results are given at 23°C ±2°C and 50% ±25% RH.

	CA9 Through-hole and SMD		CE9 Through-hole and SMD	
	Test conditions	Typical variation of nominal resistance	Test conditions	Typical variation of nominal resistance
Damp heat	500 h. at 40°C and 95% RH	+5%, -2%	500 h. at 40°C and 95% RH	±2%
Thermal cycles	16 h at 85°C, plus 2 h at -25°C	±2.5%	16 h at 90°C, plus 2 h at -40°C	±2%
Load life	1.000 h. at 50°C	+0%; -6%	1.000 h. at 70°C	±2%
Mechanical life	1.000 cycles at 10 c.p.m. and at 23°C ± 2°C	±3%	1.000 cycles at 10 c.p.m. and at 23°C ± 2°C	±3%
Soldering effect	2 seconds at 350°C	±1%	2 seconds at 350°C	±1%
Storage (3 years)	3 years at 23°C ± 2°C	±3%	3 years at 23°C ± 2°C	±1%

**CA9 Through-hole and SMD**

**CE9 Through-hole and SMD**

Power derating curve:

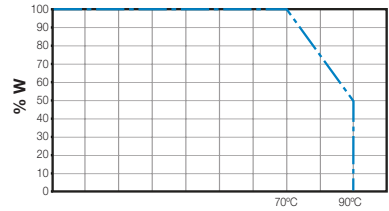
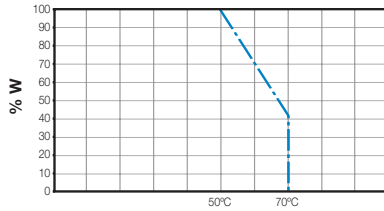

**For temperatures out of range**

The normal operation temperature for a carbon ACP potentiometer is -25°C to +70°C. When the temperature goes up to 85°C, the following variations should be observed:

Load life	1.000 h. at 50°C	+0%; -6%	1.000 h. at 85°C	+0%; -15%
-----------	------------------	----------	------------------	-----------

The power derating curve to consider is:

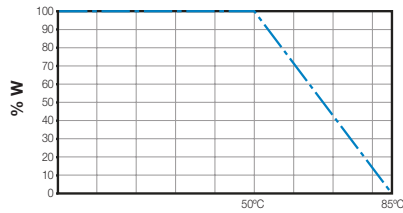

Representation of the typical variation of nominal resistance (with 95% confidence) throughout the ohm value range:

**CA9 Through-hole and SMD**

**CE9 Through-hole and SMD**

Damp heat

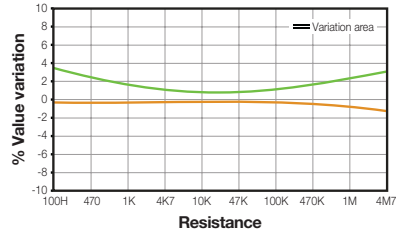
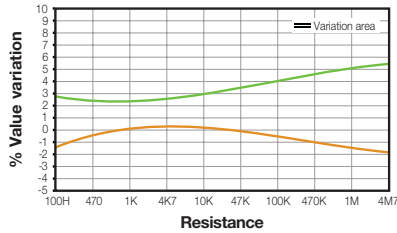

Temperature Coefficient

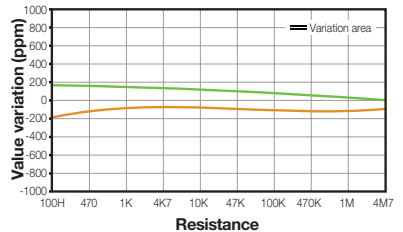
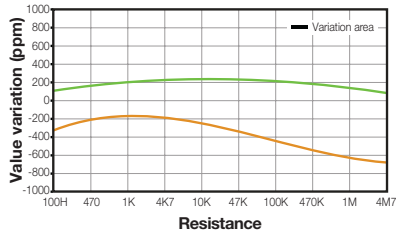

Load life

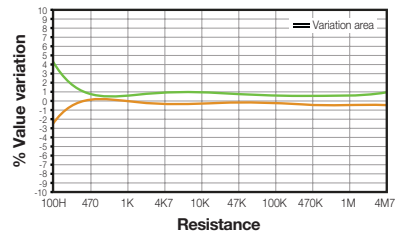
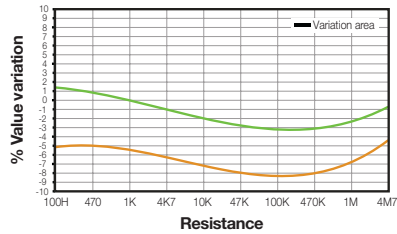

Mechanical life

