



HESTORE.HU

elektronikai alkatrész áruház

EN: This Datasheet is presented by the manufacturer.

Please visit our website for pricing and availability at www.hestore.hu.

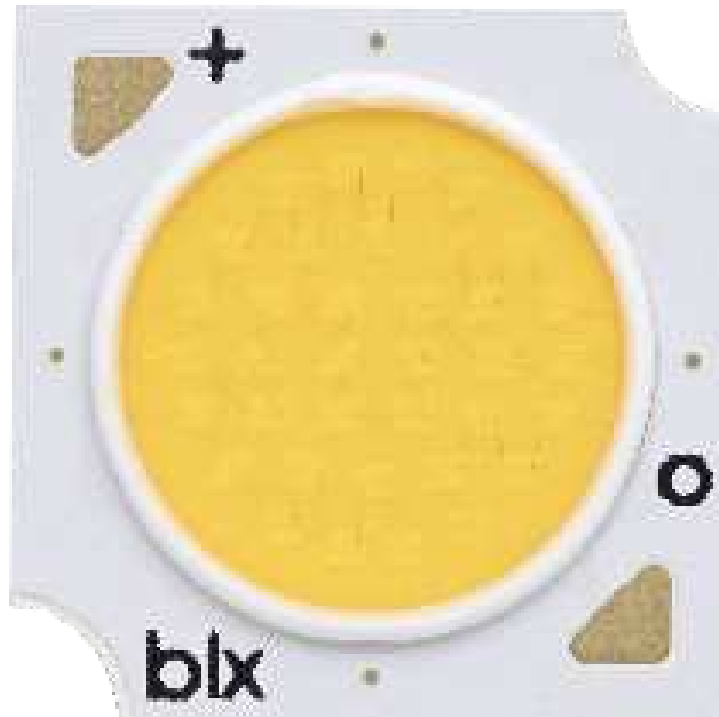

Bridgelux® Gen 8 V10 Array Series

Product Data Sheet DS412



Introduction

V Series

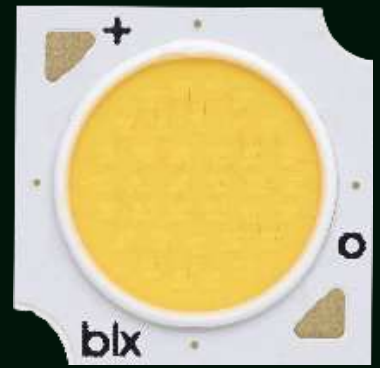

The V Series™ LED Array products deliver high quality light in a compact and cost-effective solid-state lighting package. These chip on board (CoB) arrays can be efficiently driven up to three times the nominal drive current, enabling design flexibility not previously possible. These high flux density light sources are designed to support a wide range of high quality, low cost directional luminaires and replacement lamps for both interior and exterior commercial and residential applications.

The V10 LED Array is available in a variety of electrical, CCT, and CRI combinations providing substantial design flexibility and energy efficiency advantages.

Lighting system designs incorporating these LED arrays deliver increased system level efficacy and a longer service life. Typical applications include replacement lamps and task, accent, spot, track, wide area, security, wall packs and down lights.

Features

- Efficacy of 178 lm/W typical, 3000K 80 CRI
- Reliable operation at up to 3x nominal current, 30% increase in maximum lumens per LES size
- Wide selection of CCT options (2700K-6500K) with minimum 70, 80 and 90 CRI options
- Uniform high-quality illumination
- 2 and 3 SDCM binning options (2700K – 4000K)
- Forward voltage bin codes and backside marking
- Instant light with unlimited dimming
- 5-Year warranty

Benefits

- Enables high efficiency lighting systems and lower operating costs
- Supports the trend toward luminaire miniaturization and delivers enhanced optical control
- Design flexibility for a broad range of lighting applications
- Clean white light without pixelation
- Uniform consistent white light
- Design flexibility for multi-source applications
- Easy to use with daylight and motion sensors to increase energy savings
- Design with confidence

Contents

Product Feature Map	2
Product Nomenclature	2
Product Selection Guide	3
Performance at Commonly Used Drive Currents	7
Electrical Characteristics	13
Eye Safety	14
Absolute Maximum Ratings	15
Performance Curves	16
Typical Radiation Pattern	18
Typical Color Spectrum	19
Mechanical Dimensions	20
Color Binning Information	21
Packaging and Labeling	22
Design Resources	24
Precautions	24
Disclaimers	24
About Bridgelux	25

Product Feature Map

Bridgelux arrays are fully engineered devices that provide consistent thermal and optical performance on an engineered mechanical platform. The V Series arrays are the most compact chip-on-board devices across all of

Bridgelux's LED Array products. The arrays incorporate several features to simplify design integration and assembly. Please visit www.bridgelux.com for more information on the V Series family of products.

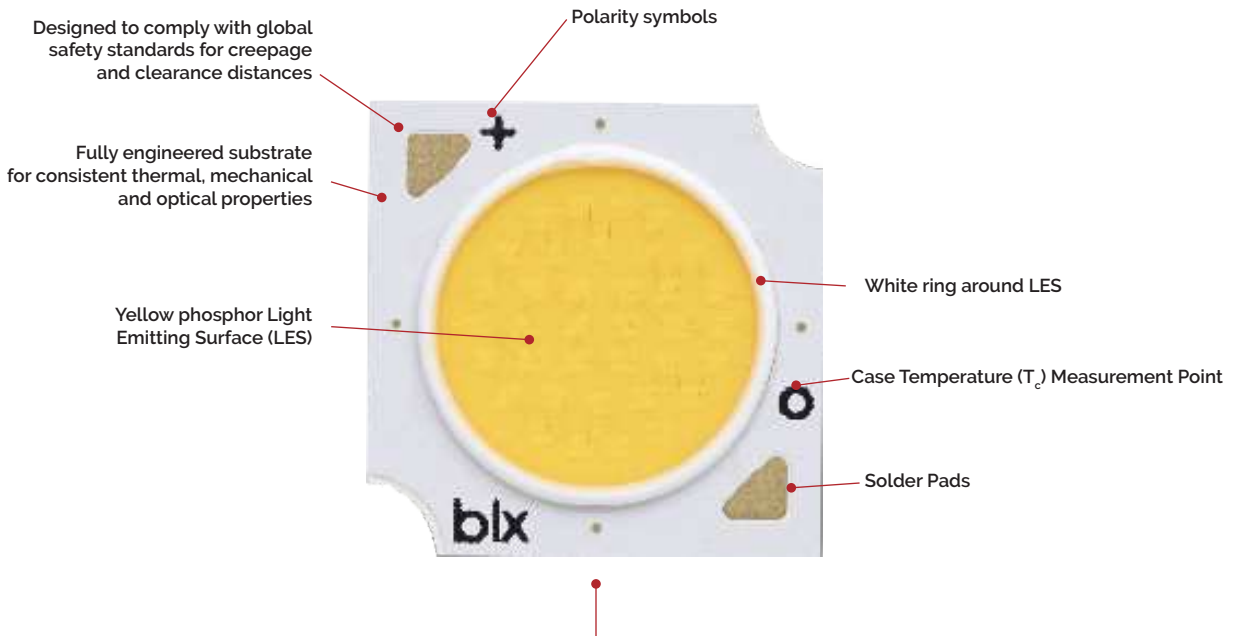

Note: Part number and lot codes are scribed on back of array

Product Nomenclature

The part number designation for Bridgelux V Series LED arrays is explained as follows:

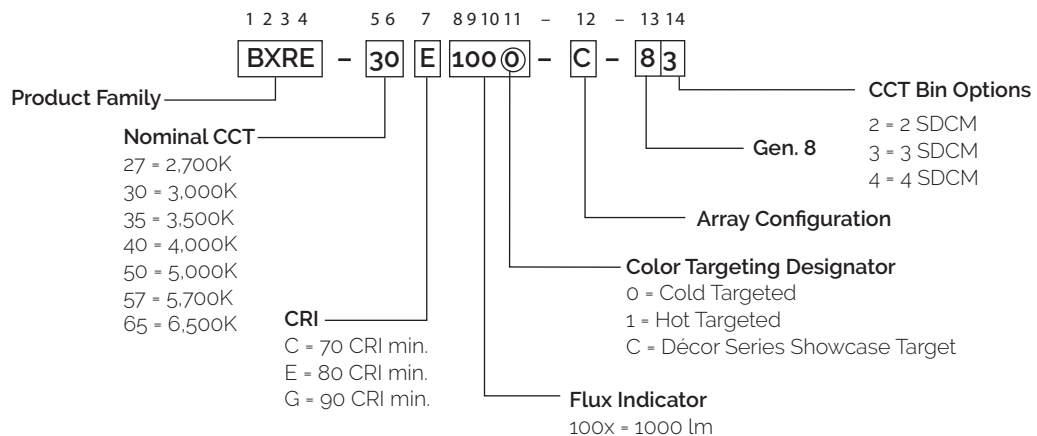

Product Selection Guide

The following product configurations are available:

Table 1: Selection Guide, Pulsed Measurement Data ($T_j = T_c = 25^\circ\text{C}$)

Part Number	Nominal CCT ¹ (K)	CRI ²	Nominal Drive Current ³ (mA)	Typical Pulsed Flux ^{4,5,6} $T_c = 25^\circ\text{C}$ (lm)	Minimum Pulsed Flux ^{6,7} $T_c = 25^\circ\text{C}$ (lm)	Typical V_f (V)	Typical Power (W)	Typical Efficacy (lm/W)
BXRE-27E1000-B-8x	2700	80	200	1145	1008	34.2	6.8	167
BXRE-27E1000-C-8x	2700	80	300	1544	1359	30.7	9.2	168
BXRE-27G1000-B-8x	2700	90	200	945	832	34.2	6.8	138
BXRE-27G1000-C-8x	2700	90	300	1274	1121	30.7	9.2	138
BXRE-27G10H0-B-8x	2700	90	200	986	867	34.2	6.8	144
BXRE-27G10H0-C-8x	2700	90	300	1329	1170	30.7	9.2	144
BXRE-30C1001-B-8x	3000	70	200	1274	1121	34.2	6.8	186
BXRE-30C1001-C-8x	3000	70	300	1718	1512	30.7	9.2	187
BXRE-30E1000-B-8x	3000	80	200	1217	1071	34.2	6.8	178
BXRE-30E1000-C-8x	3000	80	300	1641	1444	30.7	9.2	178
BXRE-30G1000-B-8x	3000	90	200	988	869	34.2	6.8	144
BXRE-30G1000-C-8x	3000	90	300	1329	1170	30.7	9.2	144
BXRE-30G10H0-B-8x	3000	90	200	1034	910	34.2	6.8	151
BXRE-30G10H0-C-8x	3000	90	300	1395	1227	30.7	9.2	151
BXRE-35E1000-B-8x	3500	80	200	1246	1096	34.2	6.8	182
BXRE-35E1000-C-8x	3500	80	300	1680	1478	30.7	9.2	182
BXRE-35G1000-B-8x	3500	90	200	1024	901	34.2	6.8	150
BXRE-35G1000-C-8x	3500	90	300	1380	1215	30.7	9.2	150
BXRE-40C1001-B-8x	4000	70	200	1310	1153	34.2	6.8	192
BXRE-40C1001-C-8x	4000	70	300	1766	1555	30.7	9.2	192
BXRE-40E1000-B-8x	4000	80	200	1253	1102	34.2	6.8	183
BXRE-40E1000-C-8x	4000	80	300	1689	1487	30.7	9.2	183
BXRE-40G1000-B-8x	4000	90	200	1045	920	34.2	6.8	153
BXRE-40G1000-C-8x	4000	90	300	1409	1240	30.7	9.2	153
BXRE-50C1001-B-8x	5000	70	200	1317	1159	34.2	6.8	193
BXRE-50C1001-C-8x	5000	70	300	1776	1563	30.7	9.2	193
BXRE-50E1001-B-8x	5000	80	200	1267	1115	34.2	6.8	185
BXRE-50E1001-C-8x	5000	80	300	1709	1504	30.7	9.2	186
BXRE-50G1001-B-8x	5000	90	200	1095	964	34.2	6.8	160
BXRE-50G1001-C-8x	5000	90	300	1477	1300	30.7	9.2	160

Notes for Table 1:

- Nominal CCT as defined by ANSI C78.377-2011. Products with a CCT of 5000K-6500K are hot targeted to $T_c = 85^\circ\text{C}$.
- CRI values are minimums for all products. Minimum Rg value for 80 CRI products is 0, the minimum Rg values for 90 CRI products is 50. Bridgelux maintains a ± 3 tolerance on Rg values.
- Drive current is referred to as nominal drive current.
- Products tested under pulsed condition (10ms pulse width) at nominal test current where T_j (junction temperature) = T_c (case temperature) = 25°C .
- Typical performance values are provided as a reference only and are not a guarantee of performance.
- Bridgelux maintains a $\pm 7\%$ tolerance on flux measurements.
- Minimum flux values at the nominal test current are guaranteed by 100% test.

Product Selection Guide

Table 1: Selection Guide, Pulsed Measurement Data ($T_j = T_c = 25^\circ\text{C}$) (Continued)

Part Number	Nominal CCT ¹ (K)	CRI ²	Nominal Drive Current ³ (mA)	Typical Pulsed Flux ^{4,5,6} $T_c = 25^\circ\text{C}$ (lm)	Minimum Pulsed Flux ^{6,7} $T_c = 25^\circ\text{C}$ (lm)	Typical V_f (V)	Typical Power (W)	Typical Efficacy (lm/W)
BXRE-57C1001-B-8x	5700	70	200	1281	1128	34.2	6.8	187
BXRE-57C1001-C-8x	5700	70	300	1728	1521	30.7	9.2	188
BXRE-57E1001-B-8x	5700	80	200	1217	1071	34.2	6.8	178
BXRE-57E1001-C-8x	5700	80	300	1641	1444	30.7	9.2	178
BXRE-65C1001-B-8x	6500	70	200	1281	1128	34.2	6.8	187
BXRE-65C1001-C-8x	6500	70	300	1728	1521	30.7	9.2	188
BXRE-65E1001-B-8x	6500	80	200	1231	1084	34.2	6.8	180
BXRE-65E1001-C-8x	6500	80	300	1660	1461	30.7	9.2	180

Notes for Table 1:

1. Nominal CCT as defined by ANSI C78.377-2011. Products with a CCT of 5000K-6500K are hot targeted to $T_c = 85^\circ\text{C}$.
2. CRI values are minimums for all products. Minimum Rg value for 80 CRI products is 0, the minimum Rg values for 90 CRI products is 50. Bridgelux maintains a ± 3 tolerance on Rg values.
3. Drive current is referred to as nominal drive current.
4. Products tested under pulsed condition (10ms pulse width) at nominal test current where T_j (junction temperature) - T_c (case temperature) = 25°C .
5. Typical performance values are provided as a reference only and are not a guarantee of performance.
6. Bridgelux maintains a $\pm 7\%$ tolerance on flux measurements.
7. Minimum flux values at the nominal test current are guaranteed by 100% test.

Product Selection Guide

Table 2: Selection Guide, Stabilized DC Performance ($T_c = 85^\circ\text{C}$)^{4,5} (Continued)

Part Number	Nominal CCT ¹ (K)	CRI ²	Nominal Drive Current ³ (mA)	Typical DC Flux ^{4,5} $T_c = 85^\circ\text{C}$ (lm)	Minimum DC Flux ⁶ $T_c = 85^\circ\text{C}$ (lm)	Typical V_f (V)	Typical Power (W)	Typical Efficacy (lm/W)
BXRE-27E1000-B-8x	2700	80	200	1031	907	33.6	6.7	154
BXRE-27E1000-C-8x	2700	80	300	1390	1223	30.1	9.0	154
BXRE-27G1000-B-8x	2700	90	200	850	748	33.6	6.7	127
BXRE-27G1000-C-8x	2700	90	300	1147	1009	30.1	9.0	127
BXRE-27G10H0-B-8x	2700	90	200	887	781	33.6	6.7	132
BXRE-27G10H0-C-8x	2700	90	300	1196	1053	30.1	9.0	132
BXRE-30C1001-B-8x	3000	70	200	1147	1009	33.6	6.7	171
BXRE-30C1001-C-8x	3000	70	300	1546	1361	30.1	9.0	171
BXRE-30E1000-B-8x	3000	80	200	1095	964	33.6	6.7	163
BXRE-30E1000-C-8x	3000	80	300	1477	1300	30.1	9.0	163
BXRE-30G1000-B-8x	3000	90	200	889	782	33.6	6.7	133
BXRE-30G1000-C-8x	3000	90	300	1196	1053	30.1	9.0	132
BXRE-30G10H0-B-8x	3000	90	200	931	819	33.6	6.7	139
BXRE-30G10H0-C-8x	3000	90	300	1255	1105	30.1	9.0	139
BXRE-35E1000-B-8x	3500	80	200	1121	987	33.6	6.7	167
BXRE-35E1000-C-8x	3500	80	300	1512	1330	30.1	9.0	167
BXRE-35G1000-B-8x	3500	90	200	921	811	33.6	6.7	137
BXRE-35G1000-C-8x	3500	90	300	1242	1093	30.1	9.0	137
BXRE-40C1001-B-8x	4000	70	200	1179	1038	33.6	6.7	176
BXRE-40C1001-C-8x	4000	70	300	1590	1399	30.1	9.0	176
BXRE-40E1000-B-8x	4000	80	200	1128	992	33.6	6.7	168
BXRE-40E1000-C-8x	4000	80	300	1520	1338	30.1	9.0	168
BXRE-40G1000-B-8x	4000	90	200	941	828	33.6	6.7	140
BXRE-40G1000-C-8x	4000	90	300	1268	1116	30.1	9.0	140
BXRE-50C1001-B-8x	5000	70	200	1186	1043	33.6	6.7	177
BXRE-50C1001-C-8x	5000	70	300	1599	1407	30.1	9.0	177
BXRE-50E1001-B-8x	5000	80	200	1140	1004	33.6	6.7	170
BXRE-50E1001-C-8x	5000	80	300	1538	1353	30.1	9.0	170
BXRE-50G1001-B-8x	5000	90	200	986	867	33.6	6.7	147
BXRE-50G1001-C-8x	5000	90	300	1329	1170	30.1	9.0	147

Notes for Table 2

- Nominal CCT as defined by ANSI C78.377-2011. Products with a CCT of 5000K-6500K are hot targeted to $T_c = 85^\circ\text{C}$.
- CRI values are minimums for all products. Minimum Rg value for 80 CRI products is 0, the minimum Rg values for 90 CRI products is 50. Bridgelux maintains a ± 3 tolerance on Rg values.
- Drive current is referred to as nominal drive current.
- Typical stabilized DC performance values are provided as reference only and are not a guarantee of performance.
- Typical performance is estimated based on operation under DC (direct current) with LED array mounted onto a heat sink with thermal interface material and the case temperature maintained at 85°C . Based on Bridgelux test setup, values may vary depending on the thermal design of the luminaire and/or the exposed environment to which the product is subjected.
- Minimum flux values at elevated temperatures are provided for reference only and are not guaranteed by 100% production testing. Based on Bridgelux test setup, values may vary depending on the thermal design of the luminaire and/or the exposed environment to which the product is subjected.

Product Selection Guide

Table 2: Selection Guide, Stabilized DC Performance ($T_c = 85^\circ\text{C}$)^{4,5} (Continued)

Part Number	Nominal CCT ¹ (K)	CRI ²	Nominal Drive Current ³ (mA)	Typical DC Flux ^{4,5} $T_c = 85^\circ\text{C}$ (lm)	Minimum DC Flux ⁶ $T_c = 85^\circ\text{C}$ (lm)	Typical V_f (V)	Typical Power (W)	Typical Efficacy (lm/W)
BXRE-57C1001-B-8x	5700	70	200	1153	1015	33.6	6.7	172
BXRE-57C1001-C-8x	5700	70	300	1555	1368	30.1	9.0	172
BXRE-57E1001-B-8x	5700	80	200	1095	964	33.6	6.7	163
BXRE-57E1001-C-8x	5700	80	300	1477	1300	30.1	9.0	163
BXRE-65C1001-B-8x	6500	70	200	1153	1015	33.6	6.7	172
BXRE-65C1001-C-8x	6500	70	300	1555	1368	30.1	9.0	172
BXRE-65E1001-B-8x	6500	80	200	1108	975	33.6	6.7	165
BXRE-65E1001-C-8x	6500	80	300	1494	1315	30.1	9.0	165

Notes for Table 2:

- Nominal CCT as defined by ANSI C78.377-2011. Products with a CCT of 5000K-6500K are hot targeted to $T_c = 85^\circ\text{C}$.
- CRI values are minimums for all products. Minimum Rg value for 80 CRI products is 0, the minimum Rg values for 90 CRI products is 50. Bridgelux maintains a ± 3 tolerance on Rg values.
- Drive current is referred to as nominal drive current.
- Typical stabilized DC performance values are provided as reference only and are not a guarantee of performance.
- Typical performance is estimated based on operation under DC (direct current) with LED array mounted onto a heat sink with thermal interface material and the case temperature maintained at 85°C . Based on Bridgelux test setup, values may vary depending on the thermal design of the luminaire and/or the exposed environment to which the product is subjected.
- Minimum flux values at elevated temperatures are provided for reference only and are not guaranteed by 100% production testing. Based on Bridgelux test setup, values may vary depending on the thermal design of the luminaire and/or the exposed environment to which the product is subjected.

Performance at Commonly Used Drive Currents

V Series LED arrays are tested to the specifications shown using the nominal drive currents in Table 1. V Series LED Arrays may also be driven at other drive currents dependent on specific application design requirements. The performance at any drive current can be derived from the current vs. voltage characteristics shown in Figures 1 & 2 and the flux vs. current characteristics shown in Figures 3 & 4. The performance at commonly used drive currents is summarized in Table 3.

Table 3: Product Performance at Commonly Used Drive Currents

Part Number	CRI	Drive Current ¹ (mA)	Typical V _f T _c = 25°C (V)	Typical Power T _c = 25°C (W)	Typical Flux ² T _c = 25°C (lm)	Typical DC Flux ³ T _c = 85°C (lm)	Typical Efficacy T _c = 25°C (lm/W)
BXRE-27E1000-B-8x	80	100	32.9	3.3	597	537	181
		150	33.6	5.0	872	785	173
		200	34.2	6.8	1145	1031	168
		270	35.0	9.5	1500	1350	159
		400	36.5	14.6	2131	1918	146
		500	37.5	18.7	2581	2323	138
BXRE-27E1000-C-8x	80	150	29.6	4.4	805	725	181
		225	30.2	6.8	1176	1058	173
		300	30.7	9.2	1544	1390	168
		360	31.2	11.2	1817	1635	162
		600	32.8	19.7	2874	2586	146
		1000	35.0	35.0	4400	3960	126
BXRE-27G1000-B-8x	90	100	32.9	3.3	493	443	150
		150	33.6	5.0	719	647	143
		200	34.2	6.8	945	850	138
		270	35.0	9.5	1238	1114	131
		400	36.5	14.6	1758	1582	120
		500	37.5	18.7	2129	1917	114
BXRE-27G1000-C-8x	90	150	29.6	4.4	664	598	150
		225	30.2	6.8	970	873	143
		300	30.7	9.2	1274	1147	138
		360	31.2	11.2	1499	1349	134
		600	32.8	19.7	2371	2134	120
		1000	35.0	35.0	3630	3267	104
BXRE-27G10H0-B-8x	90	100	32.9	3.3	514	462	156
		150	33.6	5.0	750	675	149
		200	34.2	6.8	986	887	144
		270	35.0	9.5	1291	1162	137
		400	36.5	14.6	1834	1651	126
		500	37.5	18.7	2221	1999	118
BXRE-27G10H0-C-8x	90	150	29.6	4.4	693	624	156
		225	30.2	6.8	1012	911	149
		300	30.7	9.2	1329	1196	144
		360	31.2	11.2	1564	1407	139
		600	32.8	19.7	2473	2226	126
		1000	35.0	35.0	3787	3408	108

Notes for Table 3:

1. Alternate drive currents in Table 3 are provided for reference only and are not a guarantee of performance.
2. Bridgelux maintains a ± 7% tolerance on flux measurements.
3. Typical stabilized DC performance values are provided as reference only and are not a guarantee of performance.

Performance at Commonly Used Drive Currents

Table 3: Product Performance at Commonly Used Drive Currents (Continued)

Part Number	CRI	Drive Current ¹ (mA)	Typical V_f $T_c = 25^\circ\text{C}$ (V)	Typical Power $T_c = 25^\circ\text{C}$ (W)	Typical Flux ² $T_c = 25^\circ\text{C}$ (lm)	Typical DC Flux ³ $T_c = 85^\circ\text{C}$ (lm)	Typical Efficacy $T_c = 25^\circ\text{C}$ (lm/W)
BXRE-30C1001-B-8x	70	100	32.9	3.3	664	598	202
		150	33.6	5.0	970	873	193
		200	34.2	6.8	1274	1147	186
		270	35.0	9.5	1669	1502	176
		400	36.5	14.6	2371	2134	162
		500	37.5	18.7	2872	2584	153
BXRE-30C1001-C-8x	70	150	29.6	4.4	896	806	202
		225	30.2	6.8	1308	1177	193
		300	30.7	9.2	1718	1546	186
		360	31.2	11.2	2021	1819	180
		600	32.8	19.7	3197	2877	162
		1000	35.0	35.0	4895	4405	140
BXRE-30E1000-B-8x	80	100	32.9	3.3	634	571	193
		150	33.6	5.0	926	834	184
		200	34.2	6.8	1217	1095	178
		270	35.0	9.5	1594	1435	169
		400	36.5	14.6	2264	2038	155
		500	37.5	18.7	2742	2468	146
BXRE-30E1000-C-8x	80	150	29.6	4.4	855	770	193
		225	30.2	6.8	1249	1124	184
		300	30.7	9.2	1641	1477	178
		360	31.2	11.2	1930	1737	172
		600	32.8	19.7	3053	2748	155
		1000	35.0	35.0	4675	4207	133
BXRE-30G1000-B-8x	90	100	32.9	3.3	515	463	157
		150	33.6	5.0	752	677	149
		200	34.2	6.8	988	889	144
		270	35.0	9.5	1294	1165	137
		400	36.5	14.6	1838	1654	126
		500	37.5	18.7	2226	2004	119
BXRE-30G1000-C-8x	90	150	29.6	4.4	693	624	156
		225	30.2	6.8	1012	911	149
		300	30.7	9.2	1329	1196	144
		360	31.2	11.2	1564	1407	139
		600	32.8	19.7	2473	2226	126
		1000	35.0	35.0	3787	3408	108
BXRE-30G10H0-B-8x	90	100	32.9	3.3	539	485	164
		150	33.6	5.0	787	709	156
		200	34.2	6.8	1034	931	151
		270	35.0	9.5	1355	1219	143
		400	36.5	14.6	1925	1732	132
		500	37.5	18.7	2331	2098	124

Notes for Table 3:

1. Alternate drive currents in Table 3 are provided for reference only and are not a guarantee of performance.
2. Bridgelux maintains a $\pm 7\%$ tolerance on flux measurements.
3. Typical stabilized DC performance values are provided as reference only and are not a guarantee of performance.

Performance at Commonly Used Drive Currents

Table 3: Product Performance at Commonly Used Drive Currents (Continued)

Part Number	CRI	Drive Current ¹ (mA)	Typical V _f T _c = 25°C (V)	Typical Power T _c = 25°C (W)	Typical Flux ² T _c = 25°C (lm)	Typical DC Flux ³ T _c = 85°C (lm)	Typical Efficacy T _c = 25°C (lm/W)
BXRE-30G10H0-C-8x	90	150	29.6	4.4	727	654	164
		225	30.2	6.8	1062	956	156
		300	30.7	9.2	1395	1255	151
		360	31.2	11.2	1641	1477	146
		600	32.8	19.7	2595	2336	132
		1000	35.0	35.0	3974	3576	113
BXRE-35E1000-B-8x	80	100	32.9	3.3	649	584	197
		150	33.6	5.0	948	853	188
		200	34.2	6.8	1246	1121	182
		270	35.0	9.5	1632	1468	172
		400	36.5	14.6	2318	2086	159
		500	37.5	18.7	2807	2526	150
BXRE-35E1000-C-8x	80	150	29.6	4.4	876	788	197
		225	30.2	6.8	1279	1151	188
		300	30.7	9.2	1680	1512	182
		360	31.2	11.2	1976	1778	176
		600	32.8	19.7	3125	2813	159
		1000	35.0	35.0	4785	4306	137
BXRE-35G1000-B-8x	90	100	32.9	3.3	534	480	162
		150	33.6	5.0	779	701	155
		200	34.2	6.8	1024	921	150
		270	35.0	9.5	1341	1207	142
		400	36.5	14.6	1905	1714	131
		500	37.5	18.7	2307	2076	123
BXRE-35G1000-C-8x	90	150	29.6	4.4	720	648	162
		225	30.2	6.8	1051	946	155
		300	30.7	9.2	1380	1242	150
		360	31.2	11.2	1624	1461	145
		600	32.8	19.7	2568	2311	131
		1000	35.0	35.0	3932	3539	112
BXRE-40C1001-B-8x	70	100	32.9	3.3	683	615	208
		150	33.6	5.0	997	898	198
		200	34.2	6.8	1310	1179	192
		270	35.0	9.5	1716	1544	181
		400	36.5	14.6	2437	2194	167
		500	37.5	18.7	2952	2657	157
BXRE-40C1001-C-8x	70	150	29.6	4.4	921	829	208
		225	30.2	6.8	1345	1210	198
		300	30.7	9.2	1766	1590	192
		360	31.2	11.2	2078	1870	185
		600	32.8	19.7	3287	2958	167
		1000	35.0	35.0	5032	4529	144

Notes for Table 3:

1. Alternate drive currents in Table 3 are provided for reference only and are not a guarantee of performance.
2. Bridgelux maintains a ± 7% tolerance on flux measurements.
3. Typical stabilized DC performance values are provided as reference only and are not a guarantee of performance.

Performance at Commonly Used Drive Currents

Table 3: Product Performance at Commonly Used Drive Currents (Continued)

Part Number	CRI	Drive Current ¹ (mA)	Typical V_f $T_c = 25^\circ\text{C}$ (V)	Typical Power $T_c = 25^\circ\text{C}$ (W)	Typical Flux ² $T_c = 25^\circ\text{C}$ (lm)	Typical DC Flux ³ $T_c = 85^\circ\text{C}$ (lm)	Typical Efficacy $T_c = 25^\circ\text{C}$ (lm/W)
BXRE-40E1000-B-8x	80	100	32.9	3.3	653	588	198
		150	33.6	5.0	954	858	189
		200	34.2	6.8	1253	1128	183
		270	35.0	9.5	1641	1477	173
		400	36.5	14.6	2331	2098	160
		500	37.5	18.7	2823	2541	151
BXRE-40E1000-C-8x	80	150	29.6	4.4	881	793	198
		225	30.2	6.8	1286	1157	189
		300	30.7	9.2	1689	1520	183
		360	31.2	11.2	1987	1788	177
		600	32.8	19.7	3143	2829	160
		1000	35.0	35.0	4812	4331	137
BXRE-40G1000-B-8x	90	100	32.9	3.3	545	490	166
		150	33.6	5.0	796	716	158
		200	34.2	6.8	1045	941	153
		270	35.0	9.5	1369	1232	145
		400	36.5	14.6	1945	1750	133
		500	37.5	18.7	2355	2120	126
BXRE-40G1000-C-8x	90	150	29.6	4.4	735	661	166
		225	30.2	6.8	1073	966	158
		300	30.7	9.2	1409	1268	153
		360	31.2	11.2	1658	1492	148
		600	32.8	19.7	2622	2360	133
		1000	35.0	35.0	4015	3613	115
BXRE-50C1001-B-8x	70	100	32.9	3.3	687	618	209
		150	33.6	5.0	1003	902	199
		200	34.2	6.8	1317	1186	193
		270	35.0	9.5	1725	1553	182
		400	36.5	14.6	2451	2206	168
		500	37.5	18.7	2968	2671	158
BXRE-50C1001-C-8x	70	150	29.6	4.4	926	833	209
		225	30.2	6.8	1352	1217	199
		300	30.7	9.2	1776	1599	193
		360	31.2	11.2	2089	1880	186
		600	32.8	19.7	3305	2974	168
		1000	35.0	35.0	5060	4554	144
BXRE-50E1001-B-8x	80	100	32.9	3.3	661	594	201
		150	33.6	5.0	965	868	192
		200	34.2	6.8	1267	1140	185
		270	35.0	9.5	1660	1494	175
		400	36.5	14.6	2358	2122	162
		500	37.5	18.7	2855	2570	152

Notes for Table 3:

1. Alternate drive currents in Table 3 are provided for reference only and are not a guarantee of performance.
2. Bridgelux maintains a $\pm 7\%$ tolerance on flux measurements.
3. Typical stabilized DC performance values are provided as reference only and are not a guarantee of performance.

Performance at Commonly Used Drive Currents

Table 3: Product Performance at Commonly Used Drive Currents (Continued)

Part Number	CRI	Drive Current ¹ (mA)	Typical V _f T _c = 25°C (V)	Typical Power T _c = 25°C (W)	Typical Flux ² T _c = 25°C (lm)	Typical DC Flux ³ T _c = 85°C (lm)	Typical Efficacy T _c = 25°C (lm/W)
BXRE-50E1001-C-8x	80	150	29.6	4.4	891	802	201
		225	30.2	6.8	1301	1171	192
		300	30.7	9.2	1709	1538	185
		360	31.2	11.2	2010	1809	179
		600	32.8	19.7	3179	2861	162
		1000	35.0	35.0	4867	4381	139
BXRE-50G1001-B-8x	90	100	32.9	3.3	571	514	174
		150	33.6	5.0	834	750	166
		200	34.2	6.8	1095	986	160
		270	35.0	9.5	1435	1291	152
		400	36.5	14.6	2038	1834	140
		500	37.5	18.7	2468	2221	132
BXRE-50G1001-C-8x	90	150	29.6	4.4	770	693	174
		225	30.2	6.8	1124	1012	166
		300	30.7	9.2	1477	1329	160
		360	31.2	11.2	1737	1564	155
		600	32.8	19.7	2748	2473	140
		1000	35.0	35.0	4207	3787	120
BXRE-57C1001-B-8x	70	100	32.9	3.3	668	601	203
		150	33.6	5.0	975	878	194
		200	34.2	6.8	1281	1153	187
		270	35.0	9.5	1678	1511	177
		400	36.5	14.6	2384	2146	163
		500	37.5	18.7	2888	2599	154
BXRE-57C1001-C-8x	70	150	29.6	4.4	901	811	203
		225	30.2	6.8	1315	1184	194
		300	30.7	9.2	1728	1555	187
		360	31.2	11.2	2032	1829	181
		600	32.8	19.7	3215	2893	163
		1000	35.0	35.0	4922	4430	140
BXRE-57E1001-B-8x	80	100	32.9	3.3	634	571	193
		150	33.6	5.0	926	834	184
		200	34.2	6.8	1217	1095	178
		270	35.0	9.5	1594	1435	169
		400	36.5	14.6	2264	2038	155
		500	37.5	18.7	2742	2468	146
BXRE-57E1001-C-8x	80	150	29.6	4.4	855	770	193
		225	30.2	6.8	1249	1124	184
		300	30.7	9.2	1641	1477	178
		360	31.2	11.2	1930	1737	172
		600	32.8	19.7	3053	2748	155
		1000	35.0	35.0	4675	4207	133

Notes for Table 3:

1. Alternate drive currents in Table 3 are provided for reference only and are not a guarantee of performance.
2. Bridgelux maintains a ± 7% tolerance on flux measurements.
3. Typical stabilized DC performance values are provided as reference only and are not a guarantee of performance.

Performance at Commonly Used Drive Currents

Table 3: Product Performance at Commonly Used Drive Currents (Continued)

Part Number	CRI	Drive Current ¹ (mA)	Typical V_f $T_c = 25^\circ\text{C}$ (V)	Typical Power $T_c = 25^\circ\text{C}$ (W)	Typical Flux ² $T_c = 25^\circ\text{C}$ (lm)	Typical DC Flux ³ $T_c = 85^\circ\text{C}$ (lm)	Typical Efficacy $T_c = 25^\circ\text{C}$ (lm/W)
BXRE-65C1001-B-8x	70	100	32.9	3.3	668	601	203
		150	33.6	5.0	975	878	194
		200	34.2	6.8	1281	1153	187
		270	35.0	9.5	1678	1511	177
		400	36.5	14.6	2384	2146	163
		500	37.5	18.7	2888	2599	154
BXRE-65C1001-C-8x	70	150	29.6	4.4	901	811	203
		225	30.2	6.8	1315	1184	194
		300	30.7	9.2	1728	1555	187
		360	31.2	11.2	2032	1829	181
		600	32.8	19.7	3215	2893	163
		1000	35.0	35.0	4922	4430	140
BXRE-65E1001-B-8x	80	100	32.9	3.3	642	578	195
		150	33.6	5.0	937	844	186
		200	34.2	6.8	1231	1108	180
		270	35.0	9.5	1613	1452	171
		400	36.5	14.6	2291	2062	157
		500	37.5	18.7	2775	2497	148
BXRE-65E1001-C-8x	80	150	29.6	4.4	865	779	195
		225	30.2	6.8	1264	1137	186
		300	30.7	9.2	1660	1494	180
		360	31.2	11.2	1953	1758	174
		600	32.8	19.7	3089	2780	157
		1000	35.0	35.0	4730	4257	135

Notes for Table 3:

1. Alternate drive currents in Table 3 are provided for reference only and are not a guarantee of performance.
2. Bridgelux maintains a $\pm 7\%$ tolerance on flux measurements.
3. Typical stabilized DC performance values are provided as reference only and are not a guarantee of performance.

Electrical Characteristics

Table 4: Electrical Characteristics

Part Number	Drive Current (mA)	Forward Voltage Pulsed, $T_c = 25^\circ\text{C}$ (V) ^{1, 2, 3, 8}			Typical Coefficient of Forward Voltage ⁴ $\Delta V_f / \Delta T_c$ (mV/ $^\circ\text{C}$)	Typical Thermal Resistance Junction to Case ^{5,6} R_{j-c} ($^\circ\text{C}/\text{W}$)	Driver Selection Voltages ⁷ (V)	
		Minimum	Typical	Maximum			V_f Min. Hot $T_c = 105^\circ\text{C}$ (V)	V_f Max. Cold $T_c = -40^\circ\text{C}$ (V)
BXRE-xxx100x-B-8x	200	31.6	34.2	36.8	-11.03	0.62	30.8	37.5
	500	34.7	37.5	40.3	-12.10	0.95	33.7	41.1
BXRE-xxx100x-C-8x	300	28.4	30.7	33.0	-9.90	0.38	27.6	33.6
	1000	32.4	35	37.6	-11.29	0.55	31.5	38.4

Notes for Table 4:

- Parts are tested in pulsed conditions, $T_c = 25^\circ\text{C}$. Pulse width is 10ms.
- Voltage minimum and maximum are provided for reference only and are not a guarantee of performance.
- Bridgelux maintains a tester tolerance of $\pm 0.10\text{V}$ on forward voltage measurements.
- Typical coefficient of forward voltage tolerance is $\pm 0.1\text{mV}$ for nominal current.
- Thermal resistance values are based from test data of a 3000K 80 CRI product.
- Thermal resistance value was calculated using total electrical input power; optical power was not subtracted from input power. The thermal interface material used during testing is not included in the thermal resistance value.
- V_f min hot and max cold values are provided as reference only and are not guaranteed by test. These values are provided to aid in driver design and selection over the operating range of the product.
- This product has been designed and manufactured per IEC 62031:2014. This product has passed dielectric withstand voltage testing at 1140 V. The working voltage designated for the insulation is 70V d.c. The maximum allowable voltage across the array must be determined in the end product application.

Eye Safety

Table 5: Eye Safety Risk Group (RG) Classifications

Part Number	Drive Current (mA)	CCT			
		2700K/3000K	4000K ²	5000K ³	6500K ⁴
BXRE-xxx100x-B-8x	355	RG1	RG1	RG1	RG1
	500	RG1	RG1	RG1	RG2
BXRE-xxx100x-C-8x	395	RG1	RG1	RG1	RG1
	550	RG1	RG1	RG1	RG2
	730	RG1	RG1	RG2	RG2
	1000	RG1	RG2	RG2	RG2

Notes for Table 5:

1. Eye safety classification for the use of Bridgelux V Series LED arrays is in accordance with specification IEC/TR 62778: Application of IEC 62471 for the assessment of blue light hazard to light sources and luminaires.
2. For products classified as RG2 at 4000K, Ethr= 1980 lx.
3. For products classified as RG2 at 5000K Ethr= 1530 lx.
4. For products classified as RG2 at 6500K, Ethr= 1170 lx.
5. Please contact your Bridgelux sales representative for Ethr values at specific drive currents and CCTs not listed.

Absolute Maximum Ratings

Table 6: Maximum Ratings

Parameter	Maximum Rating	
LED Junction Temperature (T_j)	150°C	
Storage Temperature	-40°C to +105°C	
Operating Case Temperature ¹ (T_c)	105°C	
Soldering Temperature ²	300°C or lower for a maximum of 6 seconds	
	BXRE-xxx100x-B-8x	BXRE-xxx100x-C-8x
Maximum Drive Current ³	500mA	1000mA
Maximum Peak Pulsed Drive Current ⁴	560mA	1120mA
Maximum Reverse Voltage ⁵	-60V	-55V

Notes for Table 6:

1. For IEC 62717 requirement, please consult your Bridgelux sales representative.
2. Refer to Bridgelux Application Note AN101: Handling and Assembly of Bridgelux V Series LED Arrays.
3. Arrays may be driven at higher currents however lumen maintenance may be reduced, and warranty will not apply.
4. Bridgelux recommends a maximum duty cycle of 10% and pulse width of 20 ms when operating LED Arrays at maximum peak pulsed current specified. Maximum peak pulsed currents indicate values where LED Arrays can be driven without catastrophic failures.
5. Light emitting diodes are not designed to be driven in reverse voltage and will not produce light under this condition. Maximum rating provided for reference only.

Performance Curves

Figure 1: V10B Drive Current vs. Voltage

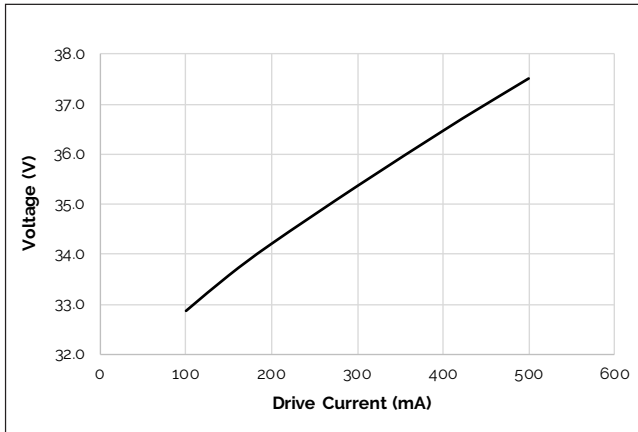

Figure 2: V10C Drive Current vs. Voltage

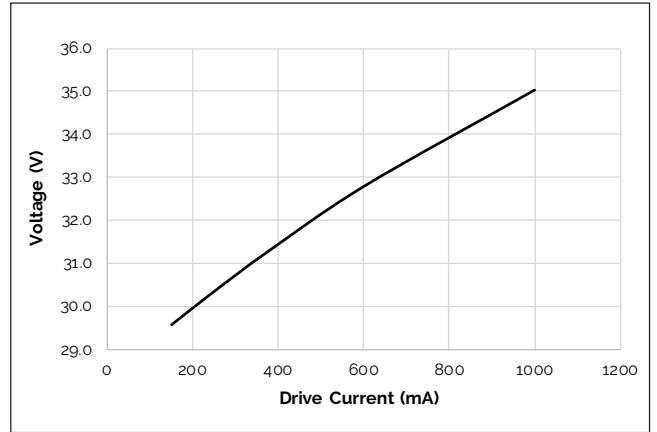

Figure 3: V10B Typical Relative Flux vs. Current

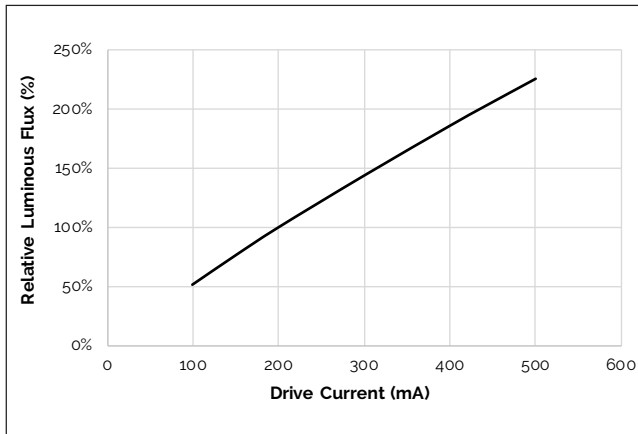
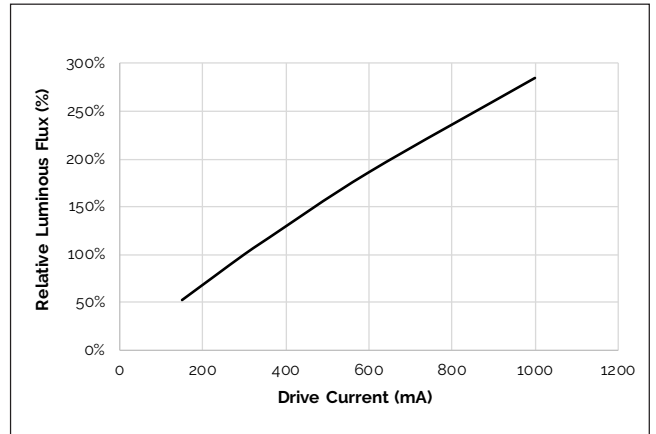

Figure 4: V10C Typical Relative Flux vs. Current



Notes for Figures 1-4:

1. Bridgelux does not recommend driving high power LEDs at low currents. Doing so may produce unpredictable results. Pulse width modulation (PWM) is recommended for dimming effects.
2. Products tested under pulsed condition (10ms pulse width) at nominal test current where T_j (junction temperature) = T_c (case temperature) = 25°C.

Performance Curves

Figure 5: Typical DC Flux vs. Case Temperature⁵

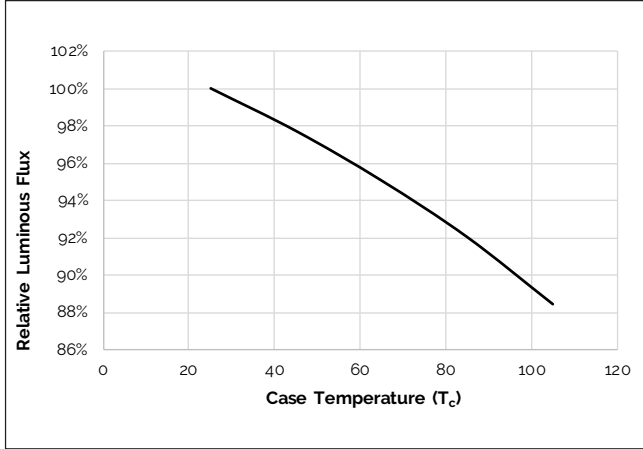

Figure 6: Typical DC ccy Shift vs. Case Temperature

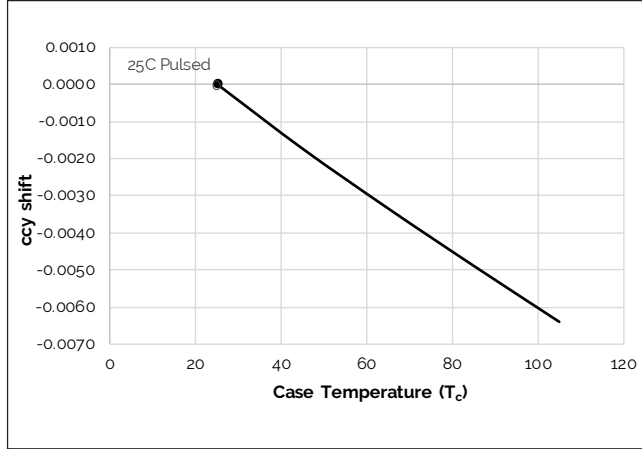
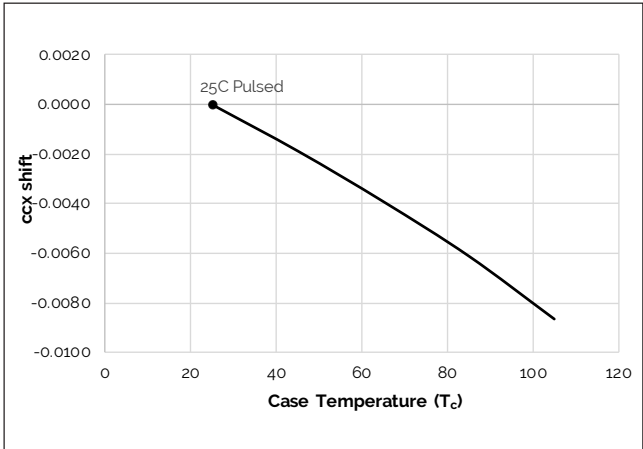
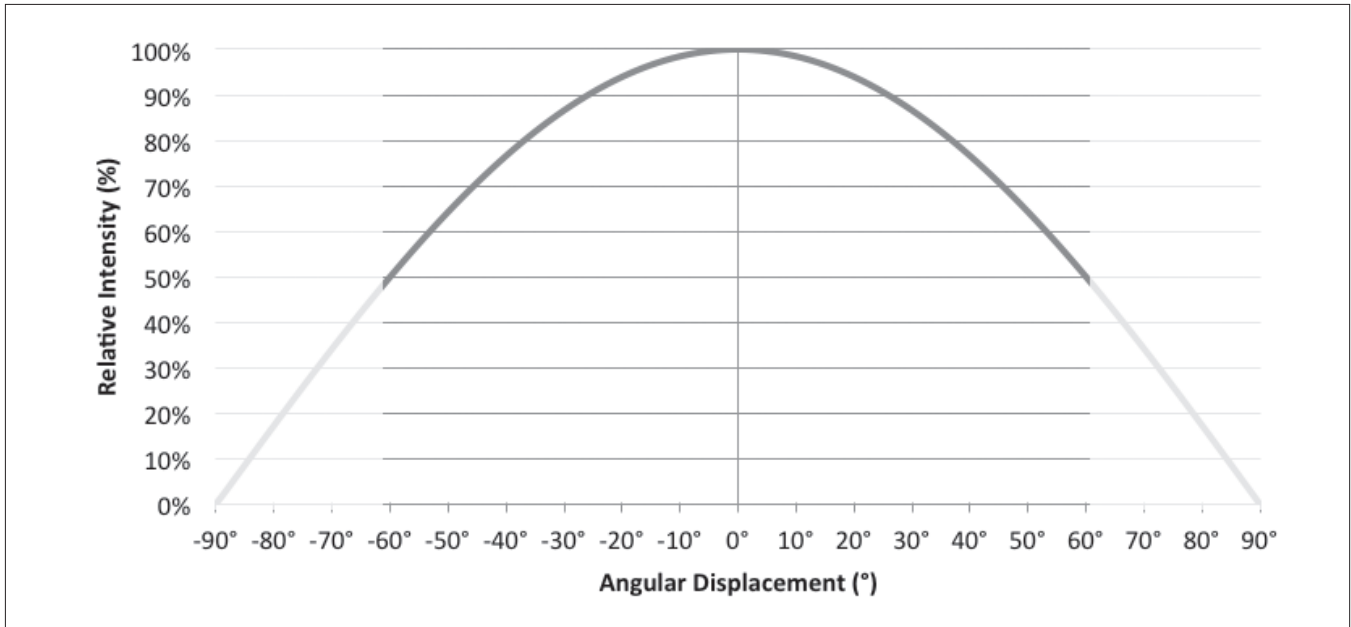

Figure 7: Typical DC ccx Shift vs. Case Temperature



Typical Radiation Pattern

Figure 8: Typical Spatial Radiation Pattern



Note for Figure 8:

1. Typical viewing angle is 120°.
2. The viewing angle is defined as the off axis angle from the centerline where intensity is ½ of the peak value.

Figure 9: Typical Polar Radiation Pattern

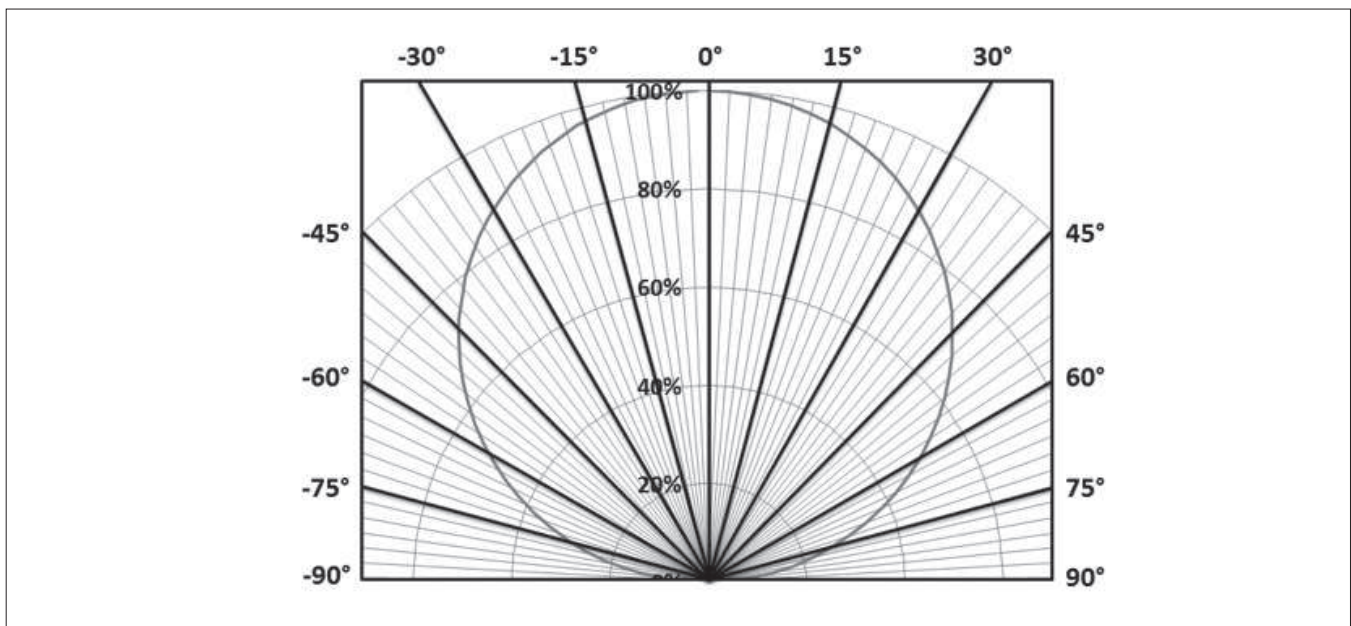

Typical Color Spectrum

Figure 10: Typical Color Spectrum

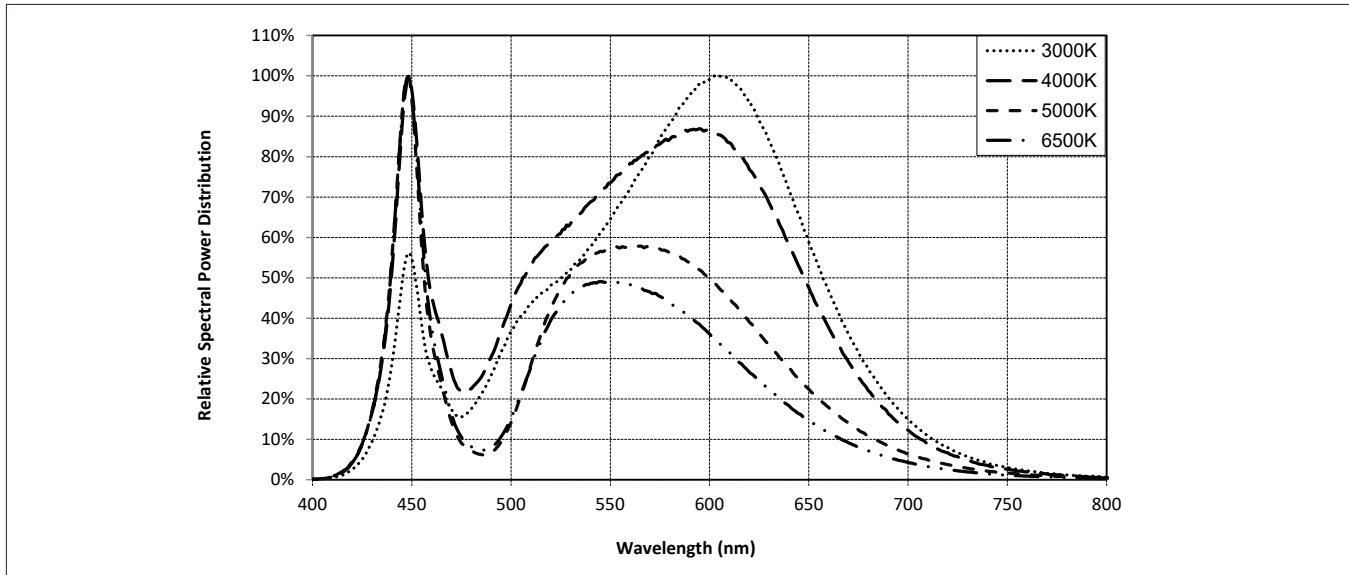

Note for Figure 10:

1. Color spectra measured at nominal current for $T_j = T_c = 25^\circ\text{C}$.
2. Color spectra shown is 3000K and 80 CRI.
3. Color spectra shown is 4000K and 80 CRI.
4. Color spectra shown is 5000K and 70 CRI.
4. Color spectra shown is 6500K and 70 CRI.

Mechanical Dimensions

Figure 11: Drawing for V10 LED Array

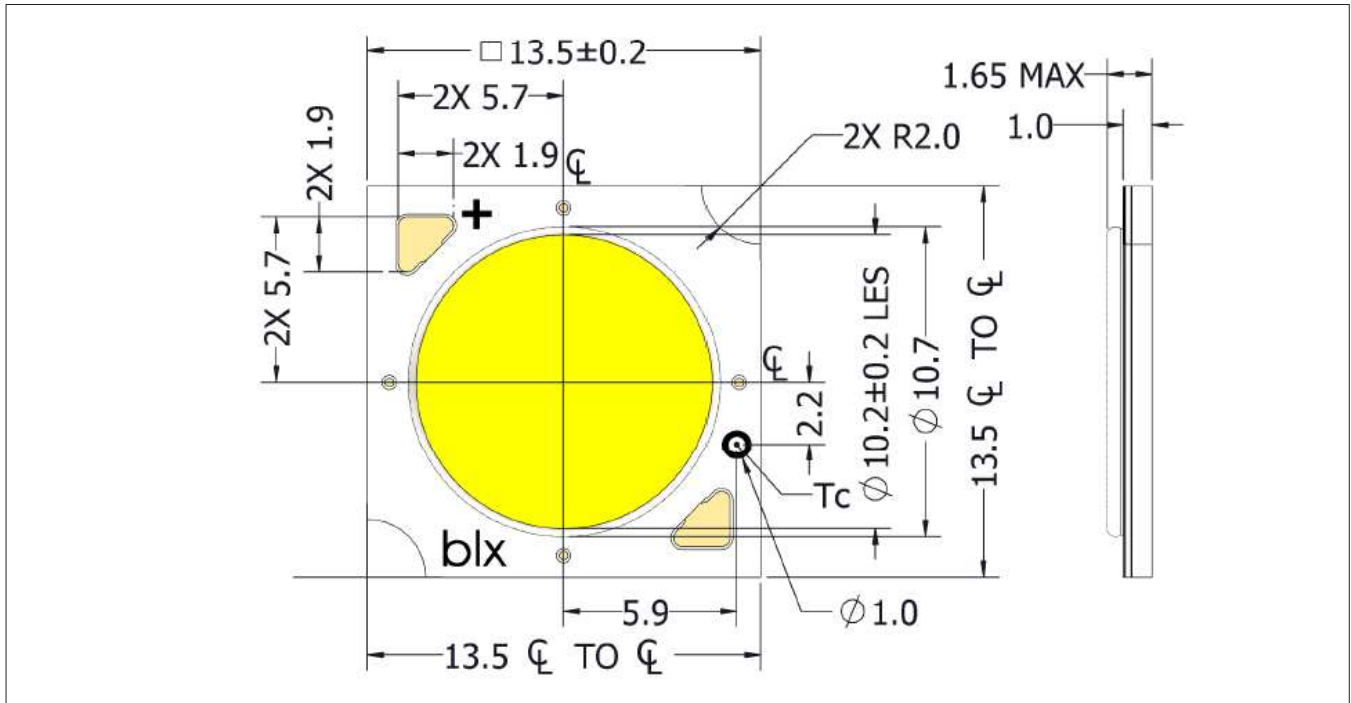

Notes for Figure 11:

1. Drawings are not to scale.
2. Drawing dimensions are in millimeters.
3. Unless otherwise specified, tolerances are ± 0.1 mm.
4. Solder pad labeled "+" denotes positive contact.
5. Refer to Application Notes AN101 for product handling, mounting and heat sink recommendations.
6. The optical center of the LED Array is nominally defined by the mechanical center of the array to a tolerance of ± 0.2 mm.
7. Bridgelux maintains a flatness of 0.10 mm across the mounting surface of the array.

Color Binning Information

Figure 12: Warm and Neutral White Test Bins in xy Color Space

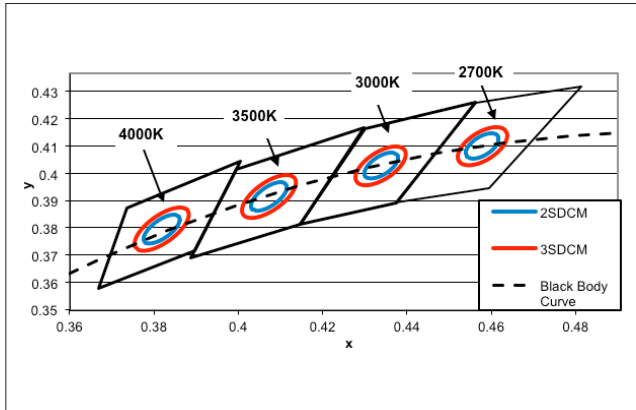

Note: Pulsed Test Conditions, $T_c = 25^\circ\text{C}$

Figure 13: Cool White Test Bins in xy Color Space

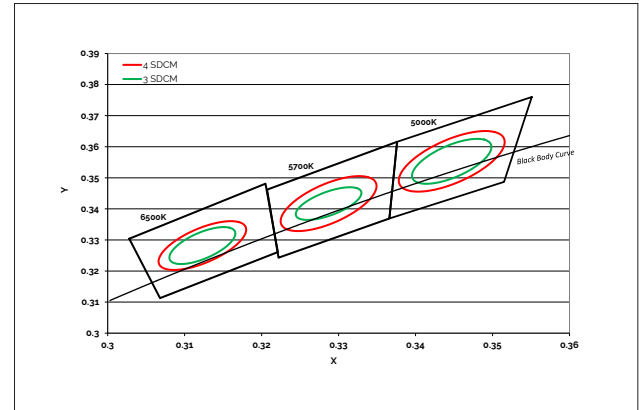

Note: Pulsed Test Conditions, $T_c = 25^\circ\text{C}$

Table 7: Warm and Neutral White xy Bin Coordinates and Associated Typical CCT

Bin Code	2700K	3000K	3500K	4000K
ANSI Bin (for reference only)	(2580K - 2870K)	(2870K - 3220K)	(3220K - 3710K)	(3710K - 4260K)
83 (3 SDCM)	(2651K - 2794K)	(2968K - 3136K)	(3369K - 3586K)	(3851K - 4130K)
82 (2 SDCM)	(2674K - 2769K)	(2995K - 3107K)	(3404K - 3548K)	(3895K - 4081K)
Center Point (x,y)	(0.4578, 0.4101)	(0.4338, 0.403)	(0.4073, 0.3917)	(0.3818, 0.3797)

Table 8: Cool White xy Bin Coordinates and Associated Typical CCT (product is hot targeted to $T_c = 85^\circ\text{C}$)

Bin Code	5000K	5700K	6500K
ANSI Bin (for reference only)	(4745K - 5311K)	(5312K - 6022K)	(6022K - 7042K)
84 (4 SDCM)	(4801K - 5282K)	(5481K - 5829K)	(6270K - 6765K)
83 (3 SDCM)	(4835K - 5215K)	(5490K - 5820K)	(6250K - 6745K)
Center Point (x,y)	(0.3447, 0.3553)	(0.3287, 0.3417)	(0.3123, 0.3282)

Packaging and Labeling

Figure 14: V10 Packaging Tube

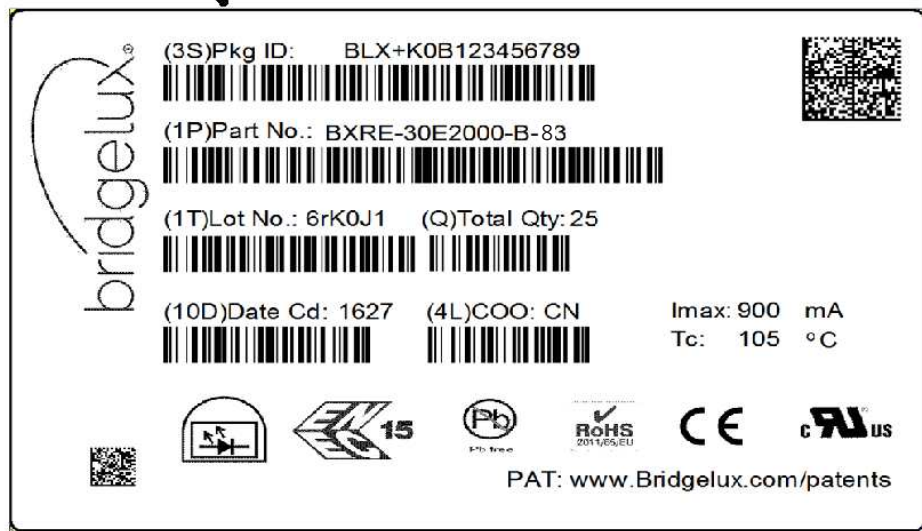

Box Label

Commercial Invoice
and Packing list



Notes for Figure 14:

1. Each tube holds 30 V10 COB arrays.
2. One tube is sealed in an anti-static bag. Four bags are placed in a shipping box. Depending on quantities ordered, a bigger shipping box, containing four boxes may be used to ship products.
3. Each bag and box is to be labeled as shown above.
4. Dimensions for each tube are 8.3 (W) x 15.4 (H) x 430 (L). Dimensions for the anti-static bag are 75 (W) x 615 (L) x 3.1 (T) mm. Dimensions for the shipping box are 58.7 x 13.3 x 7.9 cm

Packaging and Labeling

Figure 15: Gen. 8 Product Labeling

Bridgelux COB arrays have laser markings on the back side of the substrate to help with product identification. In addition to the product identification markings, Bridgelux COB arrays also contain markings for internal Bridgelux manufacturing use only. The image below shows which markings are for customer use and which ones are for Bridgelux internal use only. The Bridgelux internal manufacturing markings are subject to change without notice, however these will not impact the form, function or performance of the COB array.

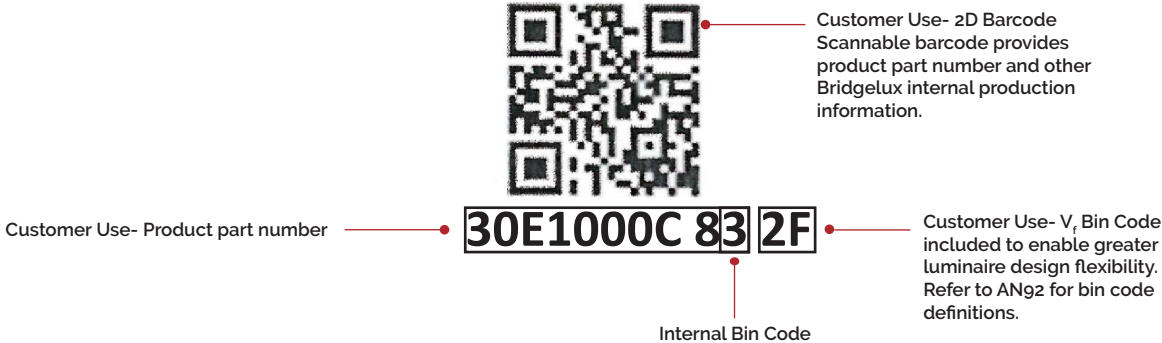

Design Resources

Application Notes

Bridgelux has developed a comprehensive set of application notes and design resources to assist customers in successfully designing with the V Series product family of LED array products. For all available application notes visit www.bridgelux.com.

Optical Source Models

Optical source models and ray set files are available for all Bridgelux products. For a list of available formats, visit www.bridgelux.com.

3D CAD Models

Three dimensional CAD models depicting the product outline of all Bridgelux V Series LED arrays are available in both IGS and STEP formats. Please contact your Bridgelux sales representative for assistance.

LM80

LM80 testing has been completed and the LM80 report is now available. Please contact your Bridgelux sales representative for LM-80 report.

Precautions

CAUTION: CHEMICAL EXPOSURE HAZARD

Exposure to some chemicals commonly used in luminaire manufacturing and assembly can cause damage to the LED array. Please consult Bridgelux Application Note AN101 for additional information.

CAUTION: RISK OF BURN

Do not touch the V Series LED array during operation. Allow the array to cool for a sufficient period of time before handling. The V Series LED array may reach elevated temperatures such that could burn skin when touched.

CAUTION

CONTACT WITH LIGHT EMITTING SURFACE (LES)

Avoid any contact with the LES. Do not touch the LES of the LED array or apply stress to the LES (yellow phosphor resin area). Contact may cause damage to the LED array.

Optics and reflectors must not be mounted in contact with the LES (yellow phosphor resin area).

Disclaimers

MINOR PRODUCT CHANGE POLICY

The rigorous qualification testing on products offered by Bridgelux provides performance assurance. Slight cosmetic changes that do not affect form, fit, or function may occur as Bridgelux continues product optimization.

STANDARD TEST CONDITIONS

Unless otherwise stated, array testing is performed at the nominal drive current.

About Bridgelux: Bridging Light and Life™

At Bridgelux, we help companies, industries and people experience the power and possibility of light. Since 2002, we've designed LED solutions that are high performing, energy efficient, cost effective and easy to integrate. Our focus is on light's impact on human behavior, delivering products that create better environments, experiences and returns—both experiential and financial. And our patented technology drives new platforms for commercial and industrial luminaires.

For more information about the company, please visit
bridgelux.com
twitter.com/Bridgelux
facebook.com/Bridgelux
youtube.com/user/Bridgelux
linkedin.com/company/bridgelux-inc-_2
WeChat ID: BridgeluxInChina



46430 Fremont Boulevard
Fremont, CA 94538 U.S.A.
Tel (925) 583-8400
www.bridgelux.com

© 2020 Bridgelux, Inc. All rights reserved. Product specifications are subject to change without notice. Bridgelux, the Bridgelux stylized logo design, Vero, V Series and V Series HD are registered trademarks, and Decor Series is a trademark of Bridgelux, Inc. All other trademarks are the property of their respective owners.

Bridgelux Gen 8 V10 Array Series Product Data Sheet DS412 Rev. A (06/2020)