



HESTORE.HU

elektronikai alkatrész áruház

EN: This Datasheet is presented by the manufacturer.

Please visit our website for pricing and availability at www.hestore.hu.

Solid State Relays 3-Phase with Integrated Heatsink Proportional Switching Controllers Types RGC2P, RGC3P



- 2-pole and 3-pole analog switching solid state contactors
- Rated operational voltage: up to 660VAC
- Rated operational current: up to 75AAC
- Control inputs: 0-20mA, 4-20mA, 12-20mA, 0-5V, 1-5V, 0-10V
- Local setting through external potentiometer
- Switching modes: phase angle or distributed full cycles (1, 4 or 16 full cycles)
- Soft start feature with selectable ramp time up to 5 seconds
- Integrated varistor protection on output
- Monitoring for SSR and load malfunction
- EMR output for alarm indication
- 100kA short circuit current rating according to UL508
- DIN or panel mount



Product Description

This series gives the possibility to control output power of 3-phase loads with an analog control input. The RGC2P is a 2-phase switching product whilst the RGC3P switches all 3 phases.

Input types cover a wide range of current and voltage ranges. Local setting by an external potentiometer is also possible. Switching modes cover phase angle control, distributed full

cycle control and soft start for limiting inrush current of loads having a high temperature coefficient, such as short wave infrared heaters.

Detection of mains loss, load loss, SSR short circuit and over-temperature is integrated in some models. Alarm condition is signalled through an EMR output and is visually indicated by the alarm LED. Additional LEDs indicate input and load status.

Ordering Key **RGC 3 P 60 V 65 C1 D F M**

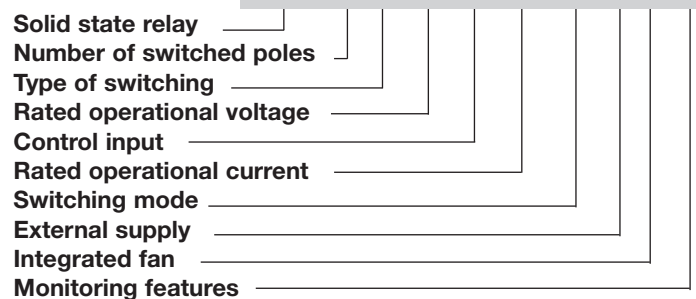

Specifications are at a surrounding temperature of 25°C unless otherwise specified.

Ordering Key (Refer to page 4 for valid part numbers)

| SSR with heatsink | Type of switching | Rated voltage (Ue), Blocking voltage | Control input ¹ | Rated current/ pole @40°C ² | Switching mode | External supply (Us) | Features |
|--|------------------------|--------------------------------------|--|--|--|---|---|
| RGC2: 2-pole switching + 1-pole direct | P: Proportional | 60: 180 - 660VAC, 1200Vp | AA: 4-20mADC I: 0-20mADC 4-20mADC 12-20mADC V: 0-5VDC 1-5VDC 0-10VDC | 15: 15AAC 25: 25AAC 40: 40AAC 75: 75AAC | C1: 1 FC ON, 1FC OFF @ 50% input C4: 4 FC ON, 4FC OFF @ 50% input | D: 24VAC/DC A: 90 - 250VAC | F: Integrated fan M: Monitoring for Mains loss, Load loss, SSR short circuit, open circuit and OTP with EMR alarm output |
| RGC3: 3-pole switching | P: Proportional | 60: 180 - 660VAC, 1200Vp | AA: 4-20mADC I: 0-20mADC 4-20mADC 12-20mADC V: 0-5VDC 1-5VDC 0-10VDC | 20: 20AAC 30: 30AAC 65: 65AAC | E: Phase Angle C1: 1 FC ON, 1FC OFF @ 50% input C4: 4 FC ON, 4FC OFF @ 50% input C16: 16 FC ON, 16FC OFF @ 50% input S: Soft Start S16: Soft Start + mode C16 | D: 24VAC/DC A: 90 - 250VAC | P: Integrated over temperature protection (OTP), mains loss with EMR alarm output F: Integrated fan M: Monitoring for Mains loss, Load loss, SSR short circuit, open circuit and OTP with EMR alarm output |

FC = Full Cycle
OTP = Over Temperature Protection
EMR = Electromechanical Relay
1. Input types I and V require an external supply Us
2. Refer to Derating Curves

Switching Modes

PHASE ANGLE switching - Mode E

The Phase angle switching mode works in accordance with the phase angle control principle. The power delivered to the load is controlled by the firing of the thyristors over each half supply cycle. The firing angle varies in relation to the input signal level which determines the output power to be delivered to the load.

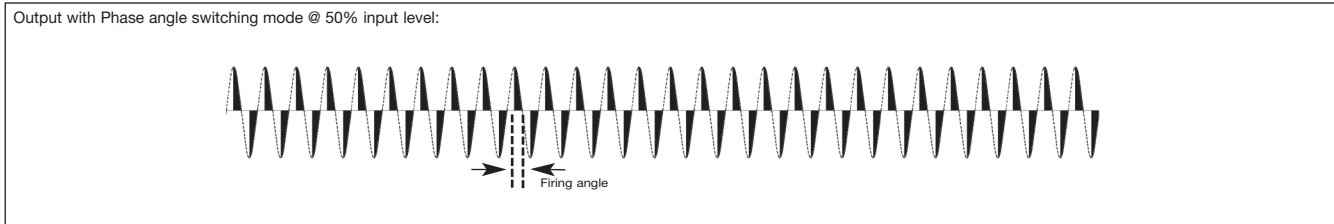

FULL CYCLE switching:

Single full cycle switching - Mode C1

In this switching mode only full cycles are switched. The number of full cycles delivered to the load over a specific time base is determined by the level of the analog input. The full cycles are DISTRIBUTED over this time base so as to ensure a fast and accurate control of the load. In mode C1, the switching resolution is 1 full cycle. Hence, @ an input level of 50% the output switching will be 1FC ON, 1FC OFF, @ 25% input 1FC ON, 3FC OFF and @ 75% input 1FC OFF, 3FC ON as shown in figure below.

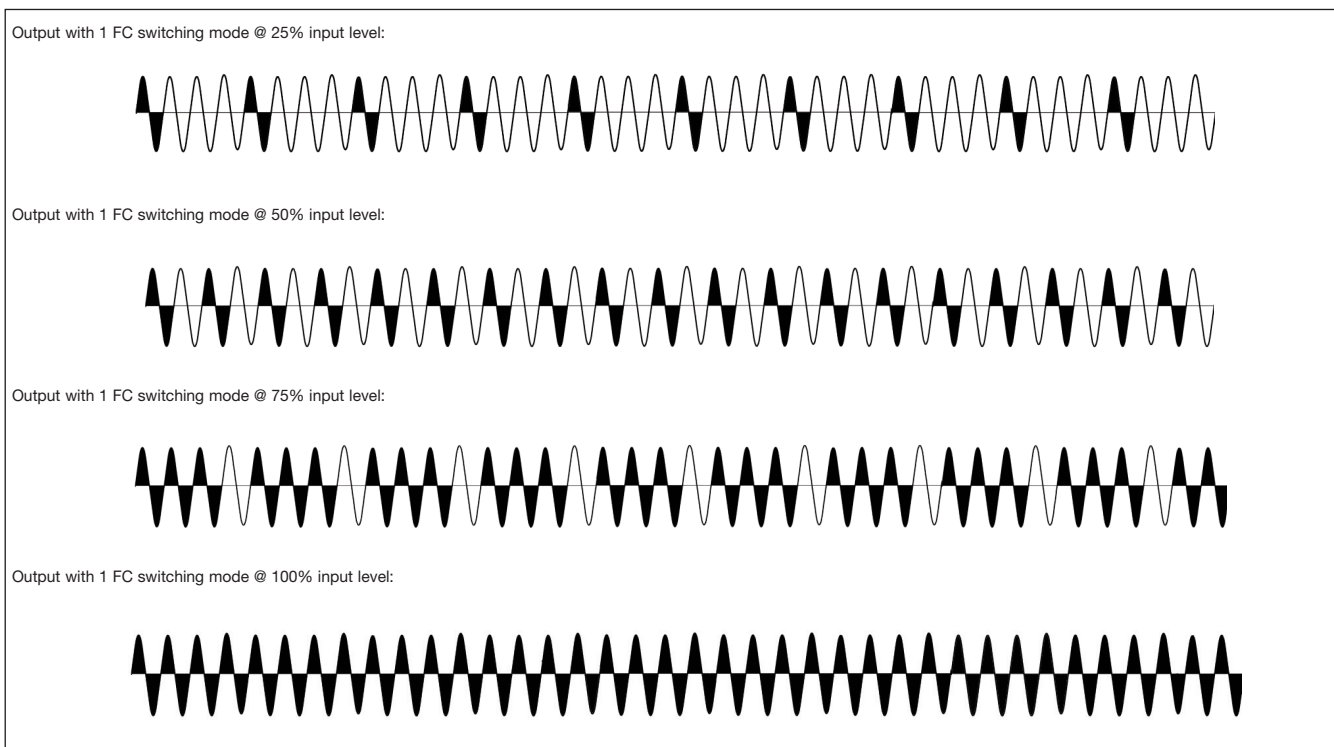

Burst full cycle switching - Mode C4 and Mode C16

The modes C4 and C16 work on the same principle of the C1 mode and hence a number of full cycles are switched in accordance to the input level distributed over a specific time base. In the case of mode C4 the lowest resolution is 4 full cycles whilst for mode C16 it is 16 full cycles. These modes are suitable for loads which have a low thermal inertia.

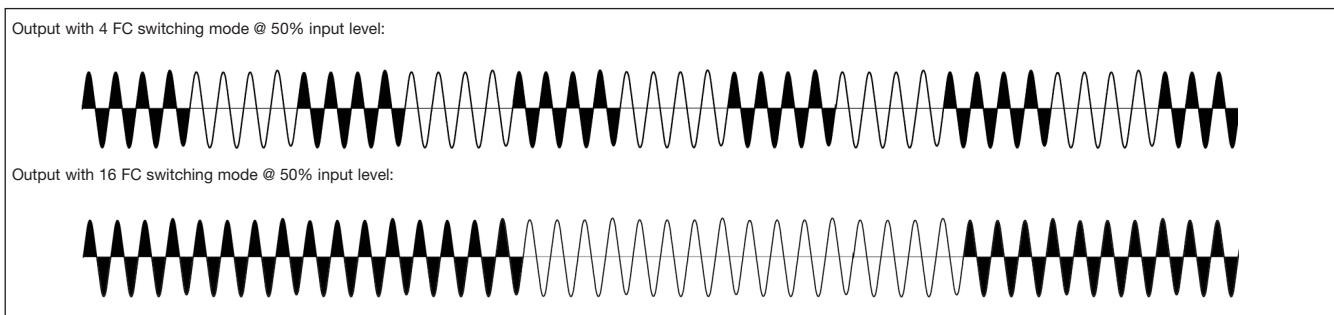

Switching Modes (continued)

SOFT START switching:

In this mode the thyristor firing angle is gradually increased in order to apply the voltage (and current) to the load smoothly and thus reduce the start-up current of loads which have a high cold to hot resistance ratio such as short wave infrared heaters.

Soft start with digital input - Mode S

On power up, the RGC3P60V..S.. performs a soft start as soon as a control input is applied. The ramp time can be set to a maximum of 5 seconds through an onboard potentiometer. After the ramp is completed, full cycles are delivered to the output as long as a control voltage (between 5 - 10V) is present on terminals A1-A4. Soft start is not performed every time the control input is applied but only in the cases where firing has been cut off for more than 5 seconds. If for some reason ramping is stopped before ramp completion, a start is assumed to have been performed and hence the 5 seconds count start once ramping is stopped.

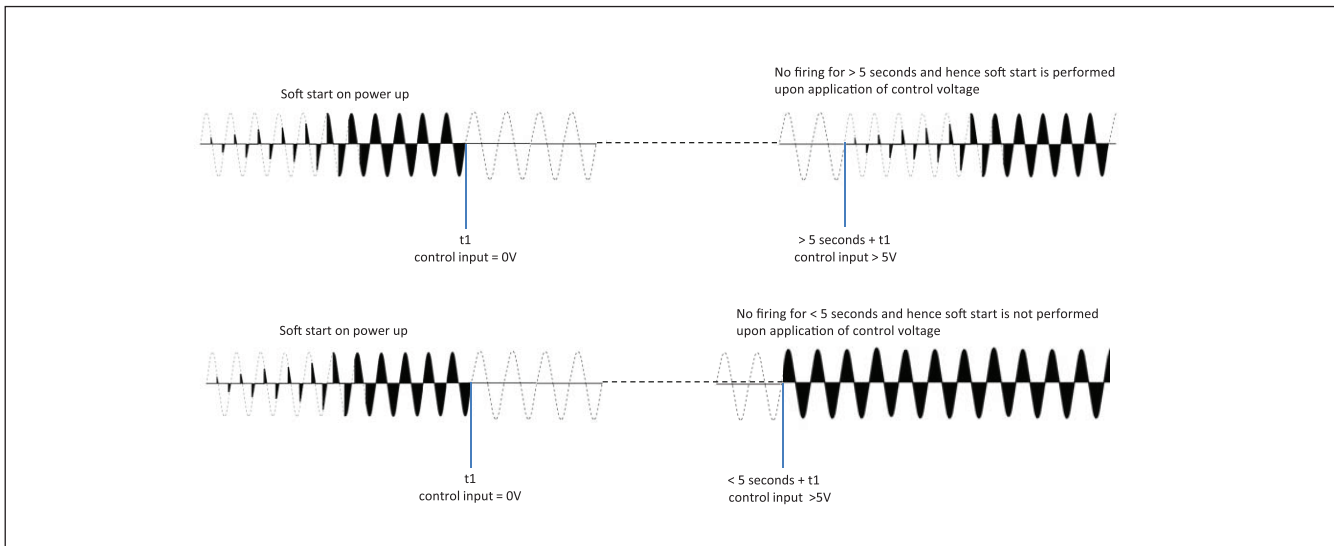

Soft start with analog input - Mode S16

This switching mode is a combination of 2 switching modes described above and hence soft start with mode S and full cycle control with mode C16. The RGC3P60V..S16 switching mode works on the principle of the mode C16 but on power up soft starting is performed to limit inrush currents loads which have a low resistance when cold. After the soft start is completed, where ramping time can be set to maximum of 5 seconds through an onboard potentiometer, the mode C16 comes into affect. Full cycles are thus delivered to the load in accordance to the input level. Soft starting is performed on power up and in case firing has been cut in the previous 5 seconds. If for some reason ramping is stopped before ramp completion, a start is assumed to have been performed and hence the 5 seconds count start once ramping is stopped.

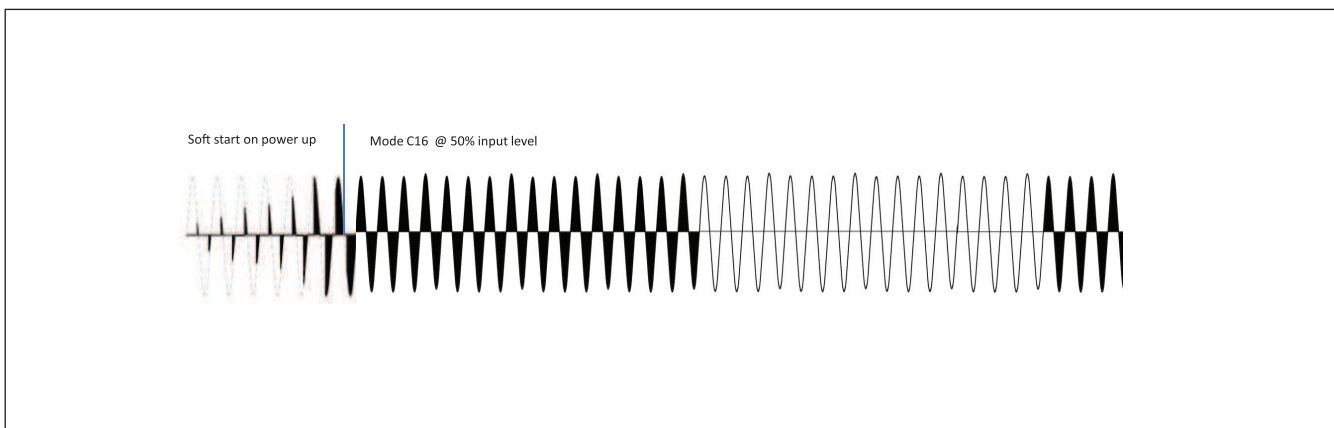

Selection Guide: RGC2P

| Current rating @ 40°C | Input type | External supply | Switching mode | | | | | |
|---------------------------------|---------------|--------------------|----------------|-----------------|-----------------|-----|---|-----|
| | | | E | C1 | C4 | C16 | S | S16 |
| 15AAC 1,800A ² s | AA | - | - | RGC2P60AA15C1 | - | - | - | - |
| | AA | - | - | RGC2P60AA25C1 | - | - | - | - |
| 25AAC 1,800A ² s | I | DC | - | RGC2P60I25C1DM | RGC2P60I25C4DM | - | - | - |
| | V | DC | - | RGC2P60V25C1DM | - | - | - | - |
| 40AAC 6,600A ² s | AA | - | - | RGC2P60AA40C1 | - | - | - | - |
| | I | DC | - | RGC2P60I40C1DM | RGC2P60I40C4DM | - | - | - |
| | V | DC | - | RGC2P60V40C1DM | - | - | - | - |
| 75AAC 15,000A ² s | I | DC | - | RGC2P60I75C1DFM | RGC2P60I75C4DFM | - | - | - |
| | | AC | - | RGC2P60I75C1AFM | RGC2P60I75C4AFM | - | - | - |
| | V | DC | - | RGC2P60V75C1DFM | - | - | - | - |
| | | AC | - | RGC2P60V75C1AFM | - | - | - | - |

Selection Guide: RGC3P

| Current rating @ 40°C | Input type | External supply | Switching mode | | | | | |
|---------------------------------|----------------------|--------------------|----------------|-----------------|-----------------|------------------|----------------|------------------|
| | | | E | C1 | C4 | C16 | S | S16 |
| 20AAC 1,800A ² s | AA | - | RGC3P60AA20E | RGC3P60AA20C1 | - | - | - | - |
| | I | DC | RGC3P60I20EDP | RGC3P60I20C1DM | RGC3P60I20C4DM | RGC3P60I20C16DM | - | - |
| | V | DC | RGC3P60V20EDP | RGC3P60V20C1DM | RGC3P60V20C4DM | RGC3P60V20C16DM | - | RGC3P60V20S16DM |
| | 5-10V digital i/p | DC | - | - | - | - | RGC3P60V20SDM | - |
| 30AAC 6,600A ² s | AA | - | RGC3P60AA30E | RGC3P60AA30C1 | - | - | - | - |
| | I | DC | RGC3P60I30EDP | RGC3P60I30C1DM | RGC3P60I30C4DM | RGC3P60I30C16DM | - | - |
| | | AC | RGC3P60I30EAP | RGC3P60I30C1AM | RGC3P60I30C4AM | RGC3P60I30C16AM | - | - |
| | V | DC | RGC3P60V30EDP | RGC3P60V30C1DM | RGC3P60V30C4DM | RGC3P60V30C16DM | - | RGC3P60V30S16DM |
| | | AC | RGC3P60V30EAP | RGC3P60V30C1AM | RGC3P60V30C4AM | RGC3P60V30C16AM | - | - |
| | 5-10V digital i/p | DC | - | - | - | - | RGC3P60V30SDM | - |
| 65AAC 15,000A ² s | I | DC | RGC3P60I65EDFP | RGC3P60I65C1DFM | RGC3P60I65C4DFM | RGC3P60I65C16DFM | - | - |
| | | AC | RGC3P60I65EAFP | RGC3P60I65C1AFM | RGC3P60I65C4AFM | RGC3P60I65C16AFM | - | - |
| | V | DC | RGC3P60V65EDFP | RGC3P60V65C1DFM | RGC3P60V65C4DFM | RGC3P60V65C16DFM | - | RGC3P60V65S16DFM |
| | | AC | RGC3P60V65EAFP | RGC3P60V65C1AFM | RGC3P60V65C4AFM | RGC3P60V65C16AFM | - | - |
| | 5-10V digital i/p | DC | - | - | - | - | RGC3P60V65SDFM | - |

Input type

AA: 4-20 mADC
I: 0-20, 4-20, 12-20 mADC
V: 0-10, 0-5, 1-5 VDC

External supply

DC: 24VAC/DC
AC: 90-250VAC

Switching mode

E: Phase Angle
C1: 1 Full Cycle
C4: 4 Full Cycles
C16: 16 Full Cycles
S: Soft Start
S16: Soft Start + 16 Full Cycles

General Specifications

| | RGC..AA.. | RGC..I.. | RGC..V.. |
|--|--|---------------------------------------|---------------------------------------|
| Latching voltage (across each pole L-T) | 20V | | |
| Operational frequency range | 45 to 65Hz | | |
| Power factor | > 0.7 @ rated voltage | | |
| Output Power | 0 to 100% | | |
| Touch Protection | IP20 | | |
| CE marking | Yes | | |
| Pollution degree | 2 (non-conductive pollution with possibilities of condensation) | | |
| Over-voltage category | III (fixed installations), 6kV (1.2 / 50 μ s) rated impulse withstand voltage Uimp | | |
| LED status indication | | | |
| Control ON | Green <4mA, flashing 0.5s ON, 0.5s OFF >4mA, intensity varies with input | Green Full intensity | Green Full intensity |
| Supply ON | n/a | Green Flashing 0.5s ON, 0.5s OFF | Green Flashing 0.5s ON, 0.5s OFF |
| Load ON | n/a | Yellow ON according to load status | Yellow ON according to load status |
| Alarm ON | Green, flashing ³ | Red, flashing ³ | Red, flashing ³ |
| Isolation | | | |
| Input & Output to Case | 4000Vrms | 4000Vrms | 4000Vrms |
| Input to Output | 2500Vrms | 2500Vrms | 2500Vrms |
| External supply to input Us to A1, A2, A3, A4, A5, Uf, 11, 12, 14, C1, C2 | n/a | 1500Vrms | 1500Vrms |
| External supply & input to EMR Us, A1, A2, A3, A4, A5, Uf, C1, C2 to 11, 12, 14 | n/a | 1500Vrms | 1500Vrms |

3: Refer to LED Indications

Output Voltage Specifications

| | |
|---|----------------------|
| Operational voltage range Line to line voltage, L1/L2/L3 | 180-660 VAC |
| Permissible voltage unbalance | 10% between L1/L2/L3 |
| Blocking voltage | 1200Vp |
| Leakage current @ rated voltage | 5mAAC per pole |
| Internal Varistors (across each pole) | Yes |

Output Specifications: RGC2

| | RGC2..15 | RGC2..25 | RGC2..40 | RGC2..75 |
|---|-----------------------|-----------------------|-----------------------|------------------------|
| Rated operational current per pole ⁴ | | | | |
| AC-51 @ Ta=25°C | 15 AAC | 32 AAC | 50 AAC | 85 AAC |
| AC-51 @ Ta=40°C | 15 AAC | 27 AAC | 40 AAC | 75 AAC |
| AC-55b @ Ta=40°C ⁵ | 15 AAC | 27 AAC | 40 AAC | 75 AAC |
| Minimum operational current | 500 mAAC | 500 mAAC | 1AAC | 1 AAC |
| Number of starts ⁵ | 130 | 35 | 10 | 240 |
| Rep. Overload Current PF = 0.7 UL508: Ta=40°C, t _{ON} =1s, t _{OFF} =9s, 50cycles | 61 AAC | 61 AAC | 107 AAC | 154 AAC |
| Maximum transient surge current (I _{tsm}), t=10ms | 600 Ap | 600 Ap | 1150 Ap | 1750 Ap |
| I ² t for fusing (t=10ms), minimum | 1800 A ² s | 1800 A ² s | 6600 A ² s | 15000 A ² s |
| Critical dv/dt (@ T _j init = 40°C) | 1000 V/μs | 1000 V/μs | 1000 V/μs | 1000 V/μs |

4: Refer to Derating Curves

5: Overload profile for AC-55b, I_e: AC-55b: 6x I_e - 0.2: 80 - x, where I_e = nominal current (AAC), 6xI_e = overload current (AAC), 0.2 = duration of overload current (s), 80 = ON duty cycle (%), x= number of starts. The overload profile for RGC2..75 is AC-55b: 3.2x I_e - 0.2: 80 - x

Output Specifications: RGC3

| | RGC3..20 | RGC3..30 | RGC3..65 |
|--|-----------------------|-----------------------|------------------------|
| Rated operational current per pole ⁴ | | | |
| AC-51 @ Ta=25°C | 25 AAC | 37 AAC | 71 AAC |
| AC-51 @ Ta=40°C | 20 AAC | 30 AAC | 66 AAC |
| AC-55b @ Ta=40°C ⁵ | 20 AAC | 30 AAC | 66 AAC |
| Minimum operational current | 500 mAACC | 1AAC | 1 AAC |
| Number of starts ⁵ | 140 | 18 | 230 |
| Rep. Overload Current PF = 0.7 UL508: Ta=40°C, t _{ON} =1s, t _{OFF} =9s, 50cycles | 61 AAC | 107 AAC | 154 AAC |
| Maximum transient surge current (I _{tsm}), t=10ms | 600 Ap | 1150 Ap | 1750 Ap |
| I ² t for fusing (t=10ms), minimum | 1800 A ² s | 6600 A ² s | 15000 A ² s |
| Critical dv/dt (@ T _j init = 40°C) | 1000 V/μs | 1000 V/μs | 1000 V/μs |

4: Refer to Derating Curves

5: Overload profile for AC-55b, I_e: AC-55b: 6x I_e - 0.2: 80 - x, where I_e = nominal current (AAC), 6xI_e = overload current (AAC), 0.2 = duration of overload current (s), 80 = ON duty cycle (%), x= number of starts. The overload profile for RGC3..65 is AC-55b: 3.6x I_e - 0.2: 80 - x

Input Specifications

| | | RGC..AA.. | RGC..I.. | RGC..V.. |
|---------------------------------|---|-----------------------|---|---|
| Control input | | 4 - 20mADC | 0 - 20mADC 4 - 20mADC 12 - 20mADC | 0 - 5VDC 1 - 5VDC 0 - 10VDC 5 - 10 VDC (digital) |
| | RGC3P..S | | | |
| Drop out voltage | RGC3P..S | - | - | < 4VDC |
| External potentiometer input | | n/a | n/a | 10K ohms (terminal A1, A3, A5) |
| Maximum initialisation time | | 250ms | 250ms | 250ms |
| Response time (Input to Output) | RGC..E, S | 2 half cycles | 2 half cycles | 2 half cycles |
| | RGC..C1, C4, C16, S16 | 3 half cycles | 3 half cycles | 3 half cycles |
| Input impedance | | n/a | <250 ohms | 100k ohms |
| Linearity, Output resolution | Refer to Transfer Characteristics section | | | |
| Voltage drop | | < 10VDC @ 20mA | n/a | n/a |
| Reverse protection | | Yes | Yes | Yes |
| Maximum allowable input current | | 50mA for max. 30 sec. | 50mA for max. 30 sec. | n/a |
| Input protection vs. surges | | Yes | Yes | Yes |
| Overvoltage protection | | n/a | n/a | up to 24VDC |

Note: Control input serial connection of multiple units is ONLY possible for:

1. RGC..AA versions, and
2. the versions that require an AC external supply and hence the RGC..I..AM, RGC..I..AFM, RGC..I..AP and RGC..I..AFP models

Transfer Characteristics

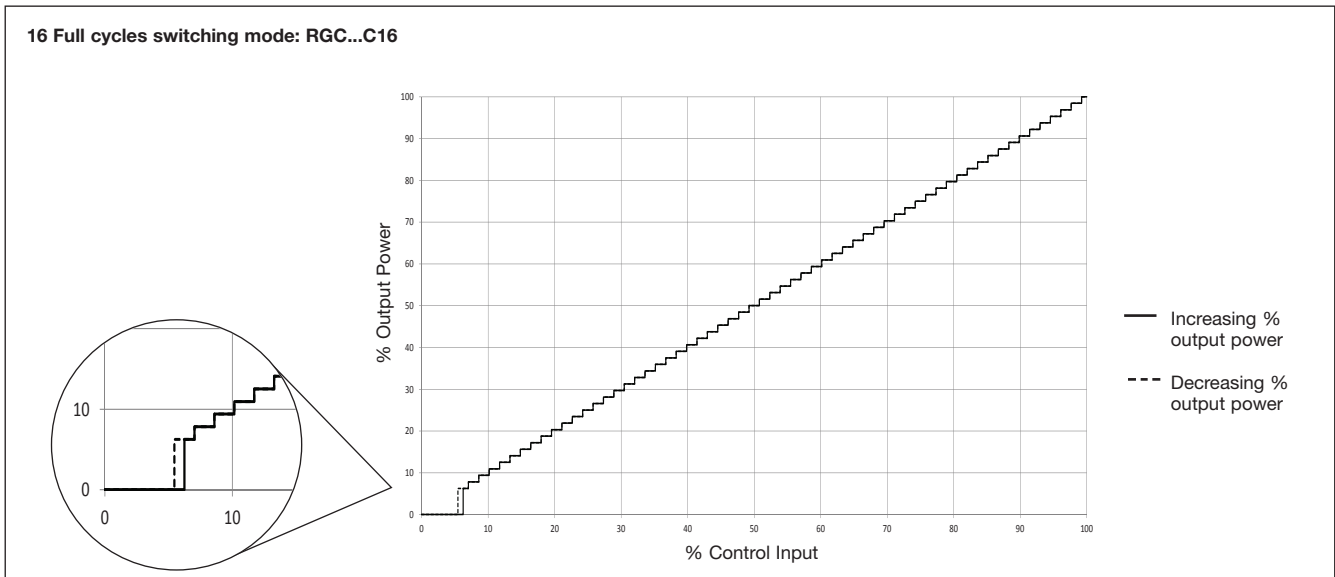
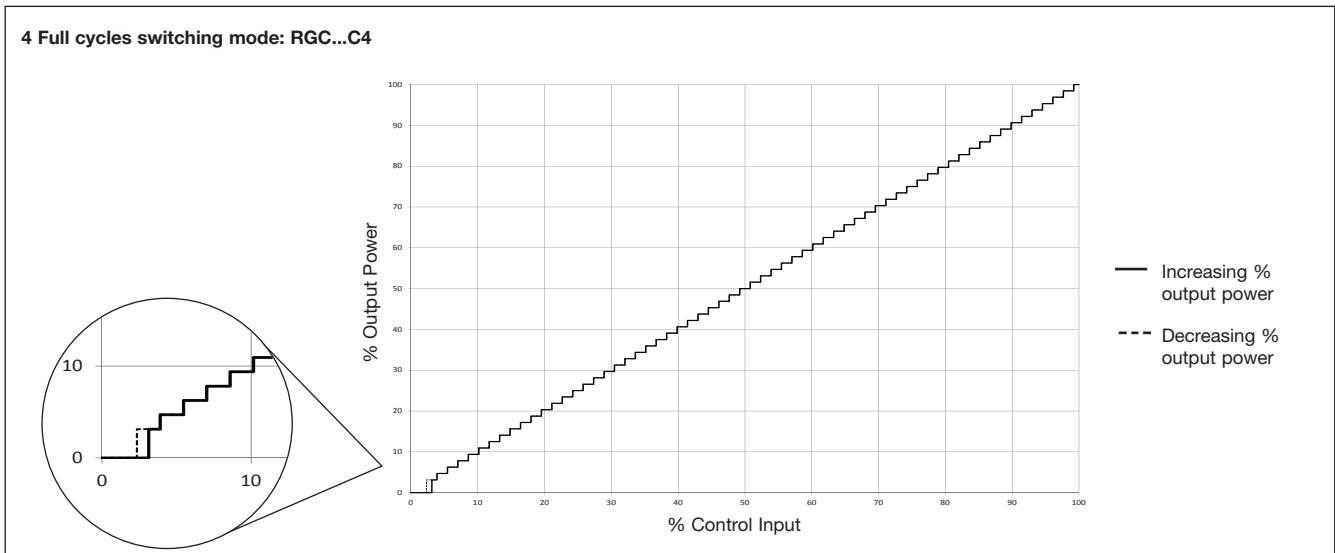
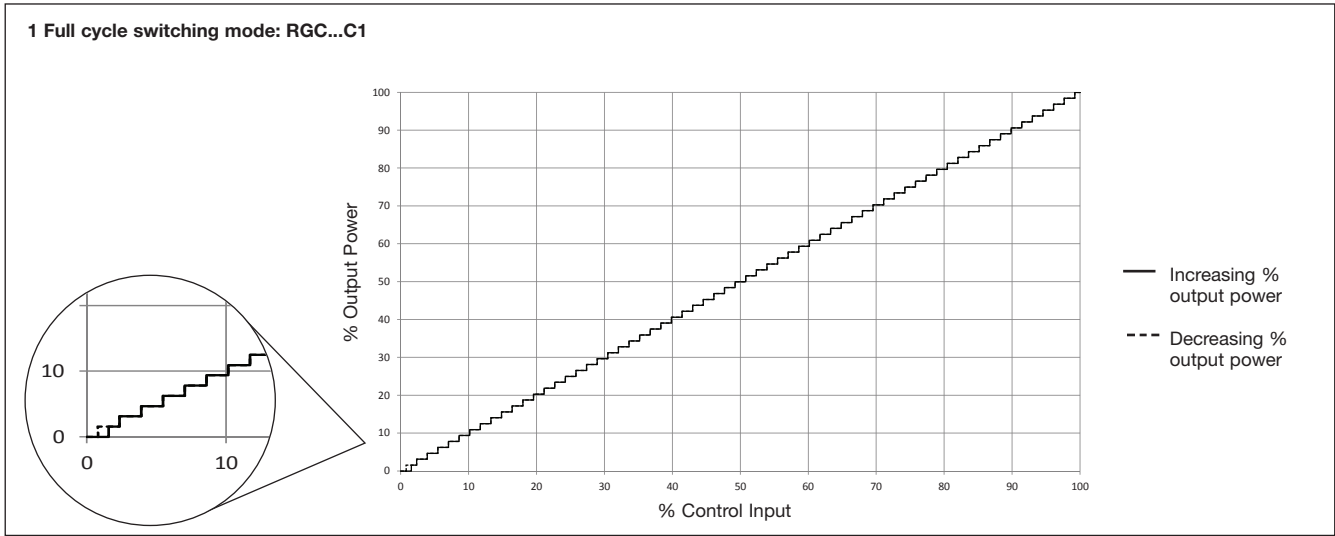

Transfer Characteristics

Phase Angle switching mode: RGC3P.E

3-phase, 3-wire systems

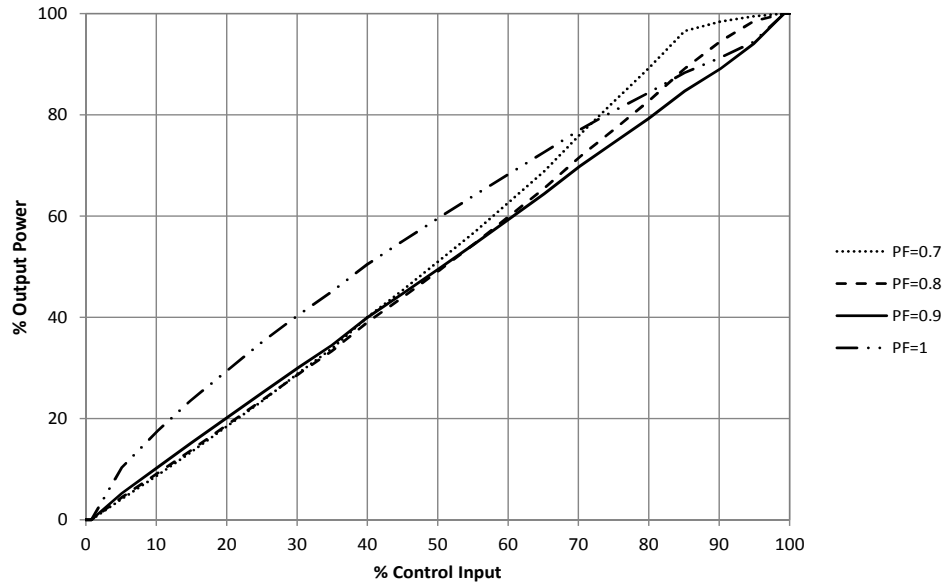

3-phase, 4-wire systems

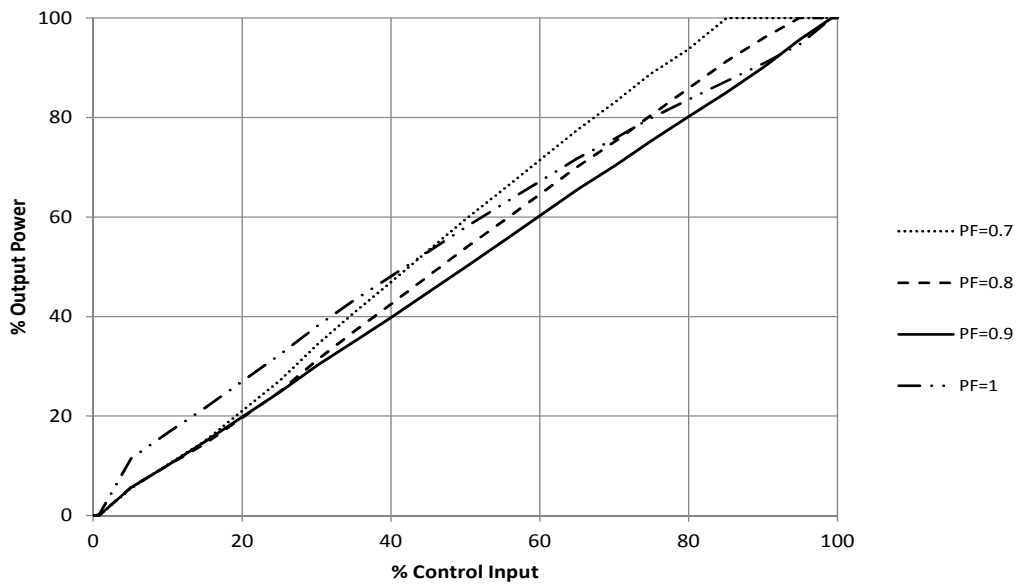

Supply Specifications (Us)

| | RGC..D.. | RGC..A.. |
|---|--|--------------|
| Supply voltage range | 24VDC, -15% / +20% 24VAC, -15% / +15% | 90-250VAC |
| Oversoltage protection | up to 32VDC/AC for 30 seconds | n/a |
| Reverse protection | Yes | n/a |
| Surge protection | Yes, integrated | Yes |
| Max. supply current no fan, RGC..P, RGC..M with fan, RGC..FP, RGC..FM | 90mA 175mA | 30mA 60mA |

Alarm Specifications (12, 14, 11)

| | RG..P RG..M |
|------------------------------------|---|
| Output type | EMR, 1 Form C Normally closed (12-11) Normally open (14-11) |
| Contact rating | 2A @ 250VAC / 30VDC |
| Isolation between open contacts | 1000VAC |

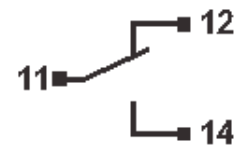

Output Power Dissipation

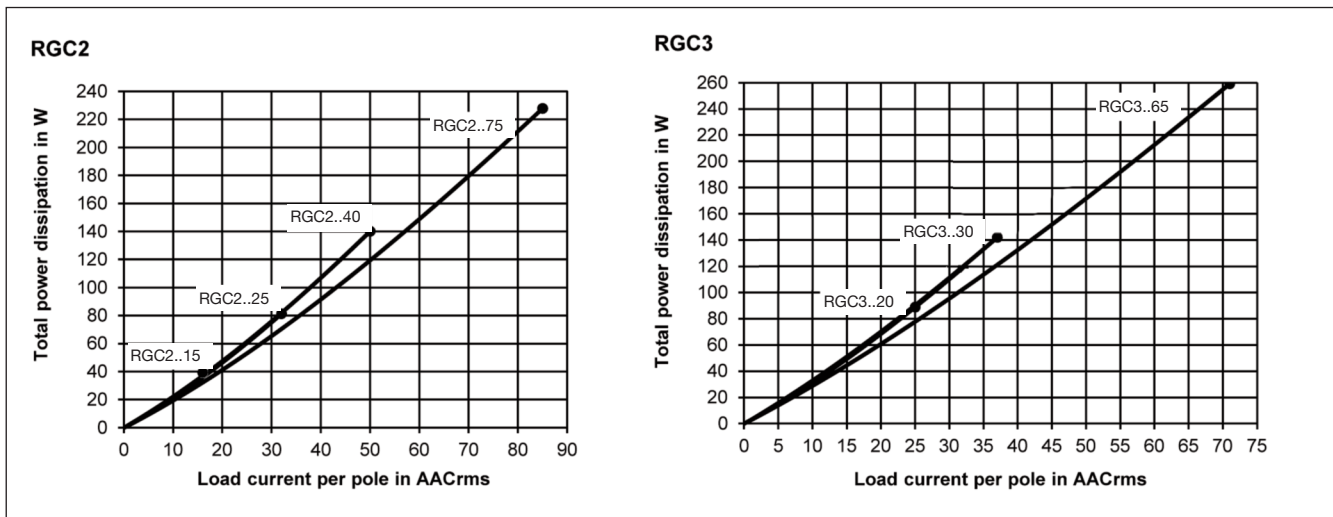

Current Derating

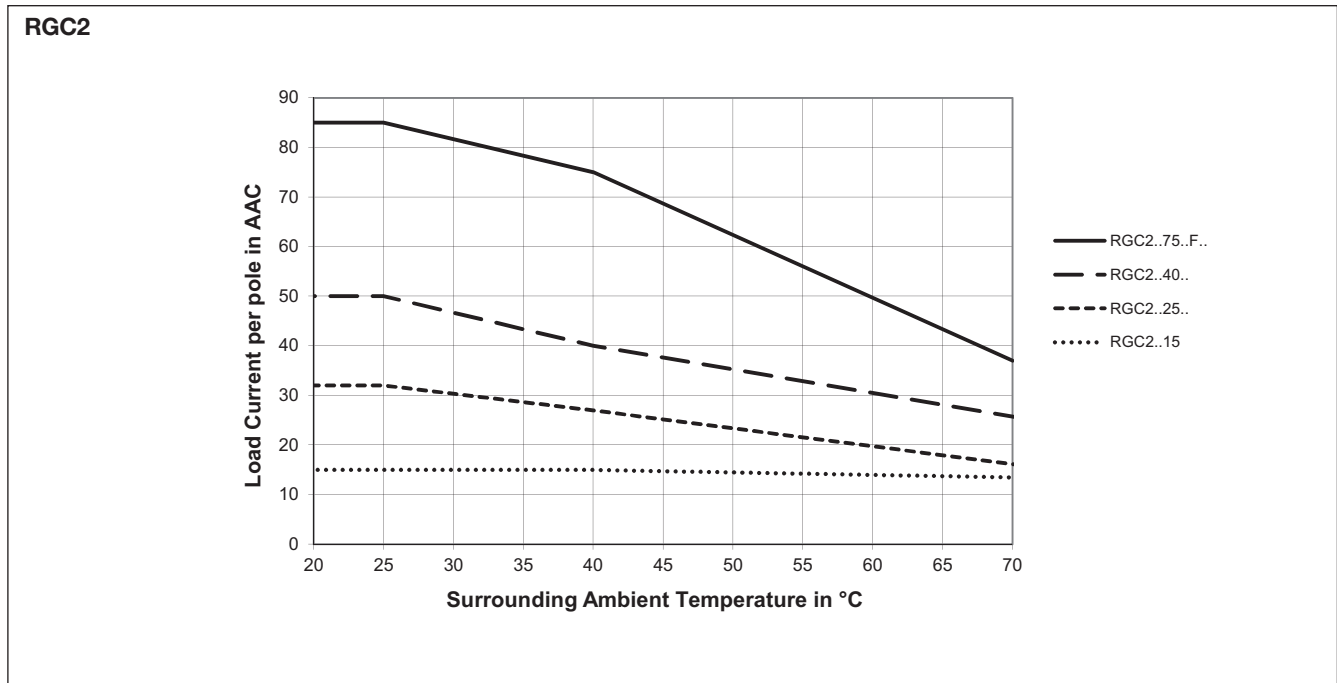

Note: Versions that utilise 24VAC external supply (Us) are limited to a maximum operating temperature of 60°C (140°F)

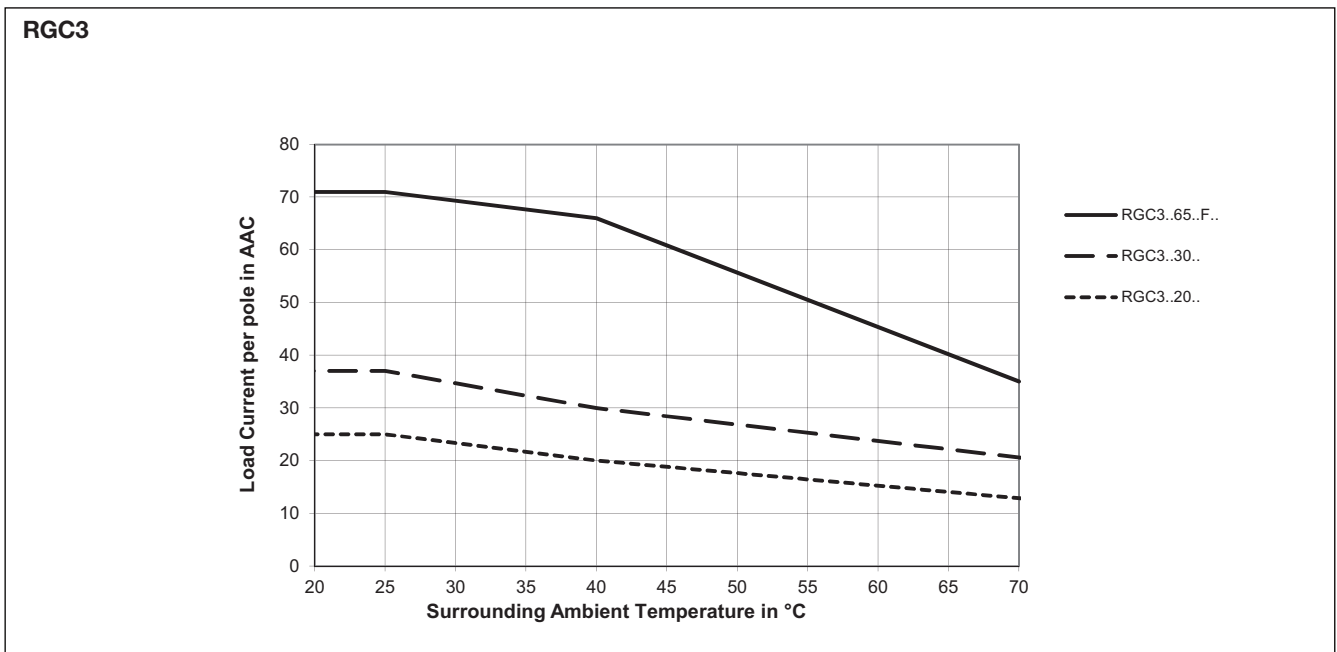

Note: Versions that utilise 24VAC external supply (Us) are limited to a maximum operating temperature of 60°C (140°F)

Current Derating with 0mm spacing

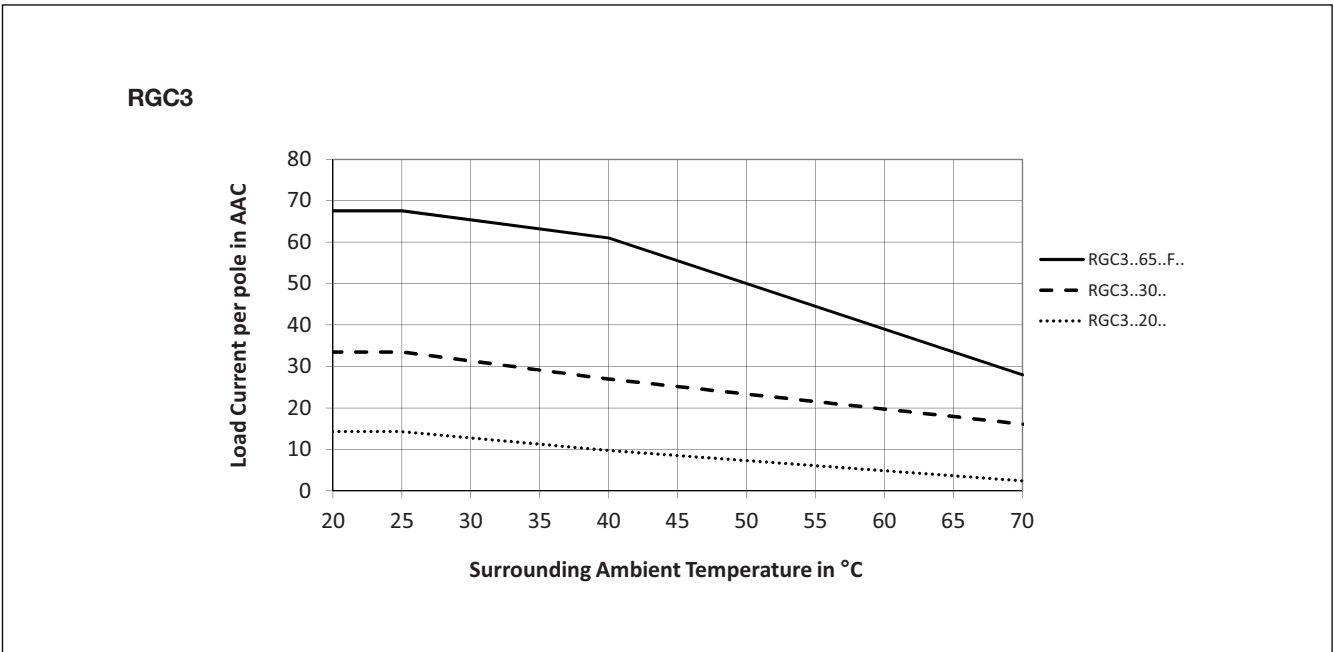
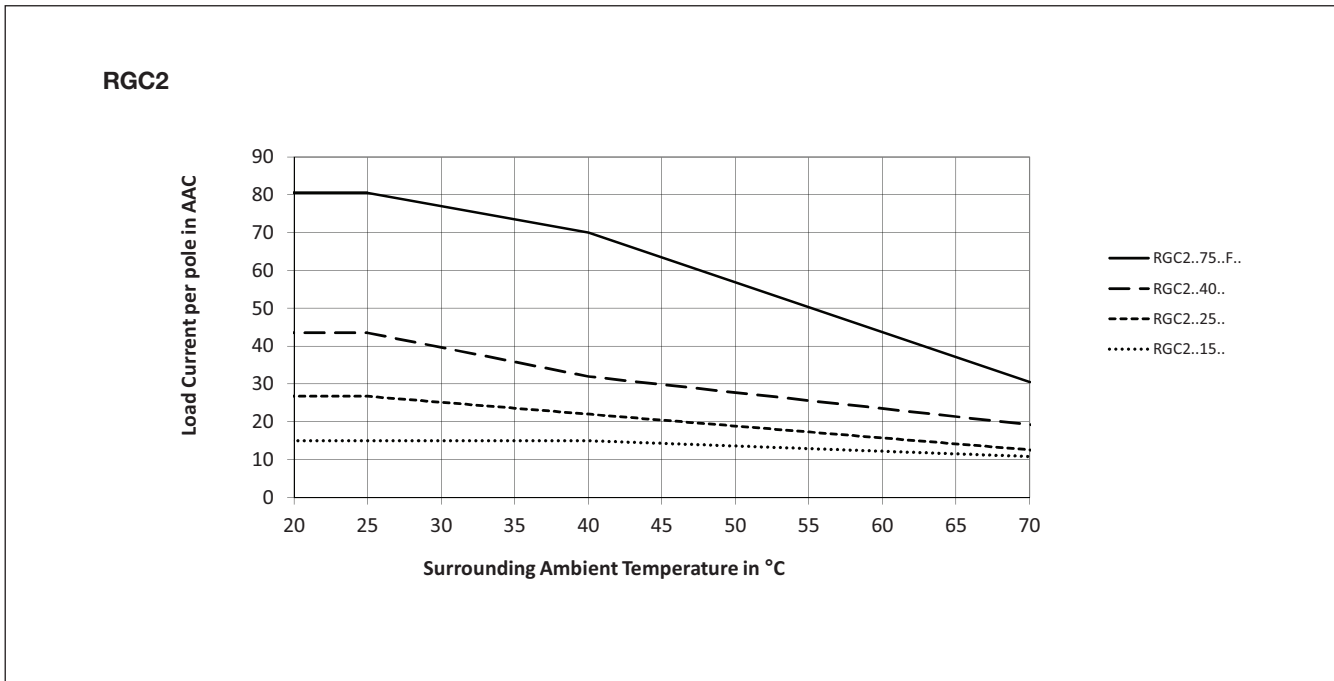

Environmental Specifications

| | |
|--|--|
| Operating temperature Us=24VAC | -40°C to +70°C (-40°F to +158°F) -40°C to +60°C (-40°F to +140°F) |
| Storage temperature | -40°C to +100°C (-40°F to +212°F) |
| EU RoHS compliant | Yes |
| China RoHS compliant | Refer to Environmental Information (Page 30) |
| Impact resistance (EN50155, EN61373) | 15/11 g/ms |
| Vibration resistance (2-100Hz, IEC60068-2-6, EN50155, EN61373) | 2g per axis |
| Relative humidity | 95% non condensing @ 40°C |

| | |
|---|---|
| UL flammability rating (for plastic) | UL 94 V0 Glow wire ignition temperature, Glow wire flammability index conform to EN 60335-1 requirements |
| Installation altitude | 0 - 1000m. Above 1000m derate linearly by 1% of FLC per 100m up to maximum of 2000m |
| Weight RGC2..15, RGC2..25 (M) RGC3..20 (M or P) RGC2..40, RGC3..30 (M or P) RGC2..75, RGC3..65 | approx. 600g (660g) approx. 600g (670g) approx. 840g (920g) approx. 990g |

Agency Approvals and Conformance

| | | | |
|-------------------------------------|------------------|-------------------------|--|
| Conformance | EN/IEC 60947-4-3 | Agency Approvals | UL Listed (E172877), UL508 |
| Short Circuit Current rating | 100kArms, UL508 | | cUL Listed (E172877), C22.2 No.14-13 CCC, GB/T 14048.5-2008 (IEC 60947-5-1) |



Electromagnetic Compatibility

| | | | |
|--|-----------------------------------|---|------------------------|
| EMC immunity | EN 60947-4-3 | Electrical fast transient (Burst) immunity | EN/IEC 61000-4-4 |
| Electrostatic discharge (ESD) immunity | EN/IEC 61000-4-2 | Output: 2kV, 5kHz | Performance Criteria 1 |
| Air discharge, 8kV | Performance Criteria 2 | Input : 1kV, 5kHz | Performance Criteria 1 |
| Contact, 4kV | Performance Criteria 2 | (A1, A2, A3, A4, A5) | |
| Electrical surge immunity | EN/IEC 61000-4-5 | Signal : 1kV, 5kHz | Performance Criteria 1 |
| Output, line to line, 1kV | Performance Criteria 2 | (Us, 11, 12, 14) | |
| Output, line to earth, 2kV | Performance Criteria 2 | Radiated radio frequency immunity | EN/IEC 61000-4-3 |
| RGC..AA.. | Performance Criteria 1 | 10V/m, 80 - 1000MHz | Performance Criteria 1 |
| A1, A2, line to line, 500V | Performance Criteria 1 | 10V/m, 1.4 - 2.0GHz | Performance Criteria 1 |
| A1, A2, line to earth, 500V | Performance Criteria 1 | 3V/m, 2.0 - 2.7GHz | Performance Criteria 1 |
| RGC..I.., RGC..V.. | | Conducted radio frequency immunity | EN/IEC 61000-4-6 |
| A1, A2, A3, A4, A5 | | 10V/m, 0.15 - 80MHz | Performance Criteria 1 |
| Line to earth, 1kV | Performance Criteria 2 | Voltage dips | EN/IEC 61000-4-11 |
| Us+, Us- | Performance Criteria 2 | 0% for 0.5, 1cycle | Performance Criteria 2 |
| Line to line, 500V | Performance Criteria 2 | 40% for 10 cycles | Performance Criteria 2 |
| Line to earth, 500V | Performance Criteria 2 | 70% for 25 cycles | Performance Criteria 2 |
| Us ~, 11, 12, 14 | Performance Criteria 2 | 80% for 250 cycles | Performance Criteria 2 |
| Line to line, 1kV | Performance Criteria 2 | Voltage interruptions immunity | EN/IEC 61000-4-11 |
| Line to earth, 2kV | Performance Criteria 2 | 0% for 5000ms | Performance Criteria 2 |
| EMC emission | EN 60947-4-3 | Radio interference field emission (radiated) | EN/IEC 55011 |
| Radio interference voltage emission (conducted) | EN/IEC 55011 | 30-1000MHz | Class A (Industrial) |
| 0.15-30MHz | Class A (with external filtering) | | |

Note:

- Control input lines must be installed together to maintain products susceptibility to Radio Frequency Interference.
- Use of AC solid state relays may according to the application and the load current, cause conducted radio interferences. Use of mains filters may be necessary for cases where the user must meet E.M.C requirements. The capacitor values given inside the filtering specification tables should be taken only as indications, the filter attenuation will depend on the final application.
- This product has been designed for Class A equipment. (External filtering may be required, refer to filtering section). Use of this product in domestic environments may cause radio interference, in which case the user may be required to employ additional mitigation methods.
- Surge tests on RGC..A models were carried out with the signal line impedance network. In case the line impedance is less than 40Ω, it is suggested that AC supply is provided through a secondary circuit where the short circuit limit between conductors and ground is 1500VA or less.
- A deviation of one step in the distributed full cycle models and up to 1.5% Full Scale Deviation in phase angle models is considered to be within PC1 criteria.

- Performance Criteria 1 (Performance Criteria A): No degradation of performance or loss of function is allowed when the product is operated as intended.

- Performance Criteria 2 (Performance Criteria B): During the test, degradation of performance or partial loss of function is allowed. However, when the test is complete the product should return operating as intended by itself.

- Performance Criteria 3 (Performance Criteria C): Temporary loss of function is allowed, provided the function can be restored by manual operation of the control.

Filtering - EN/IEC 55011 Compliance

| Part no. | Compliance to Class A emission limits | | Compliance to Class B emission limits | |
|-------------|---------------------------------------|---------------------------------|---------------------------------------|---------------------------------|
| | Max. load current | Suggested filter | Max. load current | Suggested filter |
| RGC2P.C1.. | 25AAC | 2.2uF, max. 760VAC / X1 | 25AAC | Epcos, B84143A0025R105 / 530VAC |
| | 40AAC | 2.2uF, max. 760VAC / X1 | 40AAC | Epcos, B84143A0050R105 / 530VAC |
| RGC2P.C4.. | 25AAC | 1.0uF, max. 760VAC / X1 | 25AAC | Epcos, B84143A0025R105 / 530VAC |
| | 40AAC | 1.0uF, max. 760VAC / X1 | 40AAC | Epcos, B84143A0050R105 / 530VAC |
| RGC3P.E.. | 20AAC | Epcos, B84143A0025R105 / 530VAC | 13AAC | Epcos, B84143A0025R105 / 530VAC |
| | 30AAC | Epcos, B84143D0050R127 / 530VAC | - | - |
| RGC3P.C1.. | 20AAC | 2.2uF, max. 760VAC / X1 | 20AAC | Epcos, B84143A0025R105 / 530VAC |
| | 30AAC | 2.2uF, max. 760VAC / X1 | 30AAC | Epcos, B84143A0050R105 / 530VAC |
| RGC3P.C4.. | 20AAC | 1.0uF, max. 760VAC / X1 | 20AAC | Epcos, B84143A0025R105 / 530VAC |
| | 30AAC | 1.0uF, max. 760VAC / X1 | 30AAC | Epcos, B84143A0050R105 / 530VAC |
| RGC3P.C16.. | 20AAC | 1.0uF, max. 760VAC / X1 | 20AAC | Epcos, B84143A0025R105 / 530VAC |
| | 30AAC | 1.0uF, max. 760VAC / X1 | 30AAC | Epcos, B84143A0050R105 / 530VAC |
| RGC3P.S.. | 20AAC | 1.0uF, max. 760VAC / X1 | 20AAC | Epcos, B84143A0025R105 / 530VAC |
| | 30AAC | 1.0uF, max. 760VAC / X1 | 30AAC | Epcos, B84143A0050R105 / 530VAC |

Filter Connection Diagrams

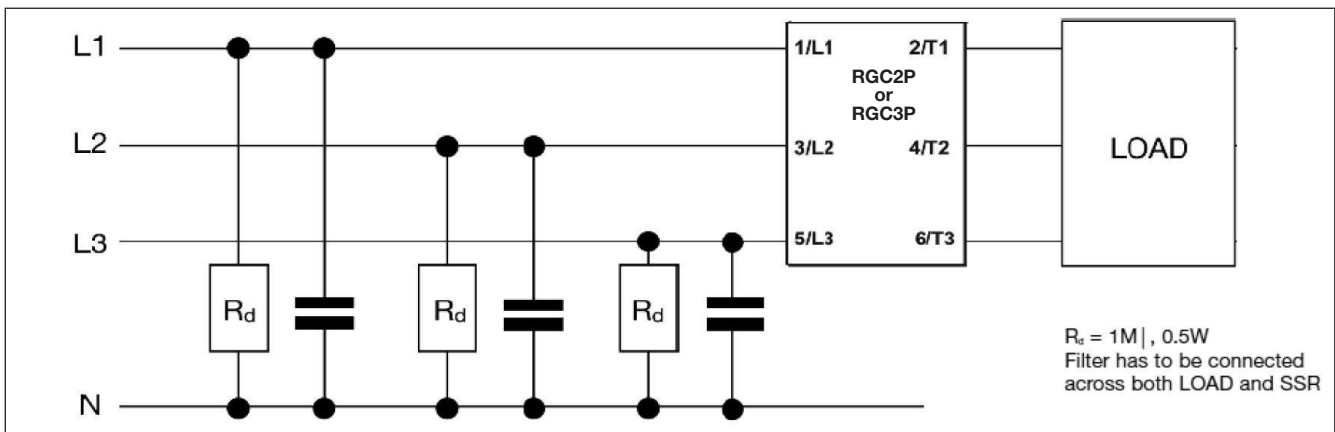
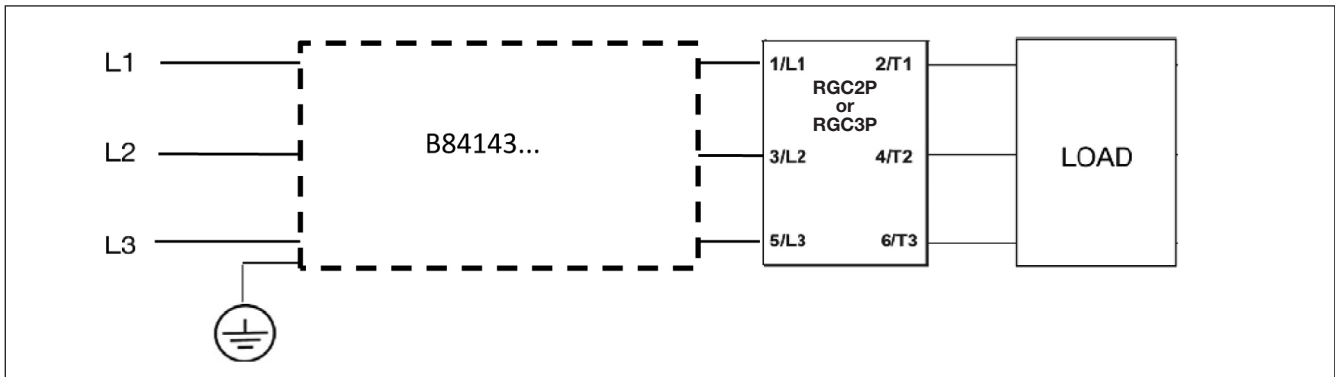

Note: The suggested filtering is determined by tests carried out on a representative setup and load. The RGC2P.., RGC3P.. is intended to be integrated within a system where conditions may differentiate from conditions utilised for tests, such as load, cable lengths and other auxiliary components that may exist within the end system. It shall be the responsibility of the system integrator to ensure that the system containing the above component complies with the applicable rules and regulations.

Epcos installation recommendations shall be taken in consideration when utilising such filters.

Terminals Layout

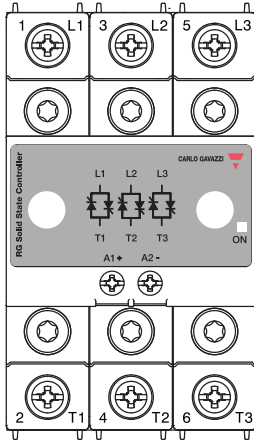

RGC2P..AA15, RGC2P..AA25, RGC2P..AA40
RGC3P..AA20, RGC3P..AA30

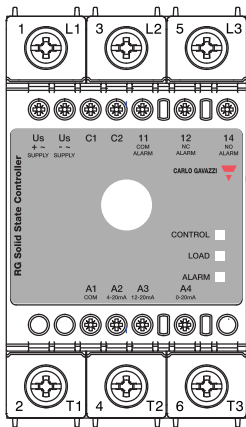

RGC2P..I25, RGC2P..I40
RGC3P..I20, RGC3P..I30

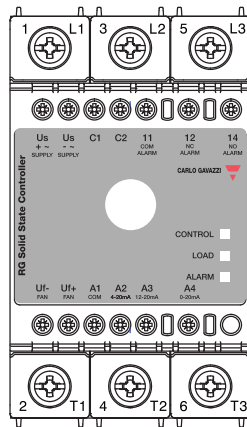

RGC2P..I75
RGC3P..I65

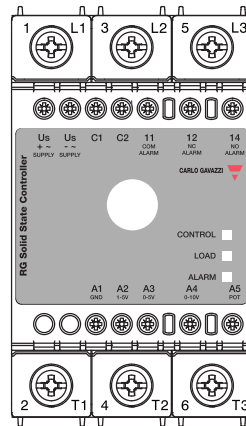

RGC2P..V25, RGC2P..V40
RGC3P..V20, RGC3P..V30

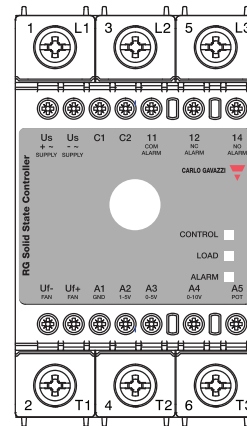

RGC2P..V75
RGC3P..V65

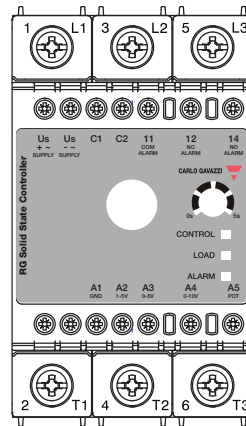

RGC3P..V20S.., RGC3P..V30S..

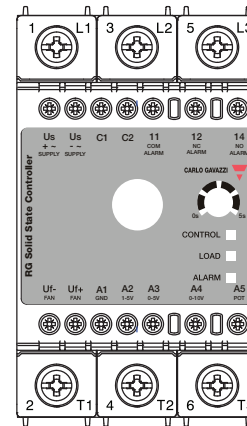

RGC3P..V65S..

Terminals Labelling:

- 1/L1, 2/L2, 3/L3: Line connections
- 2/T1, 4/T2, 6/T3: Load connections
- A1, A2: Control input
4-20mA (RGC..AA..), 4-20mA (RGC..I..), 1-5V (RGC..V..)
- A1, A3: Control input,
12-20mA (RGC..I..), 0-5V (RGC..V..)
- A1, A4: Control input
0-20mA (RGC..I..), 0-10V (RGC..V..)
- A5: External Potentiometer input (RGC..V..)
- Us (+, -): External supply, positive signal (RGC..DM, DFM, DP, DFP),
AC signal (RGC..AM, AFM, AP, AFP)
- Us (-, ~): External supply, ground (RGC..DM, DFM, DP, DFP),
AC signal (RGC..AM, AFM, AP, AFP)
- C1, C2: Configuration mode selection
External short link between C1 & C2 is required ONLY in case of 4-wire, 3-phase systems
- Uf+: Fan supply positive signal
- Uf -: Fan supply ground

Connections to Uf-, Uf+ are readily terminated by manufacturer. No other connection is required by end user.

Dimensions

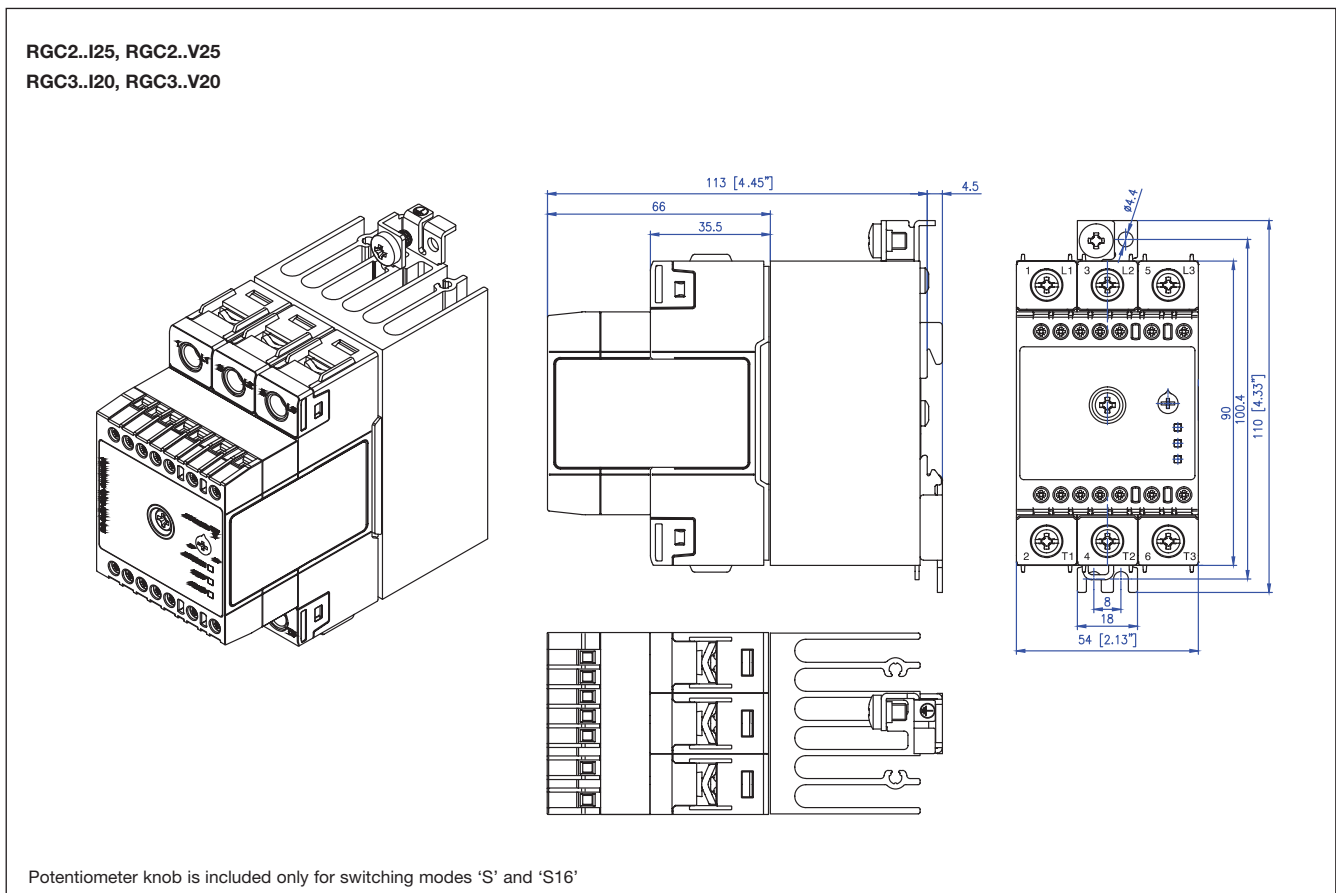
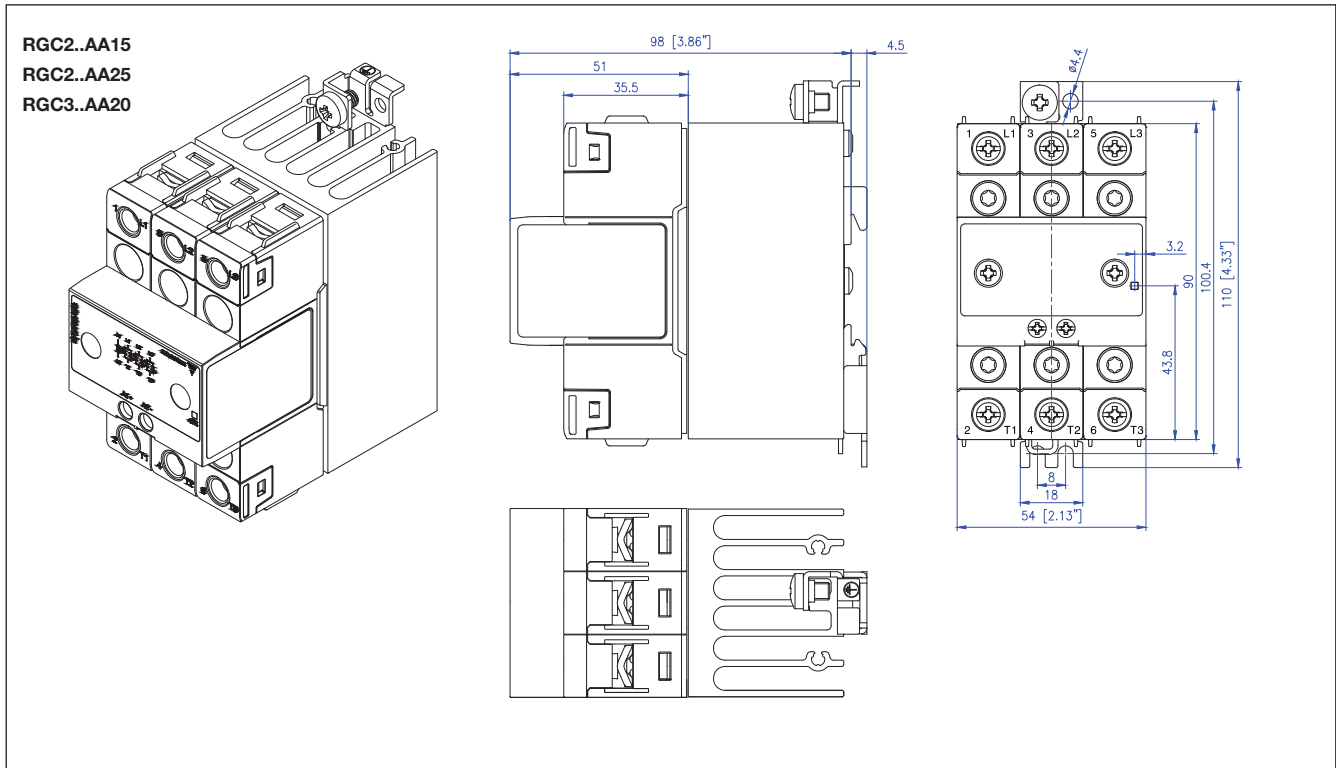

Dimensions in mm. Housing width tolerance +0.5mm, - 0mm as per DIN43880.
All other tolerances ±0.5mm

Dimensions

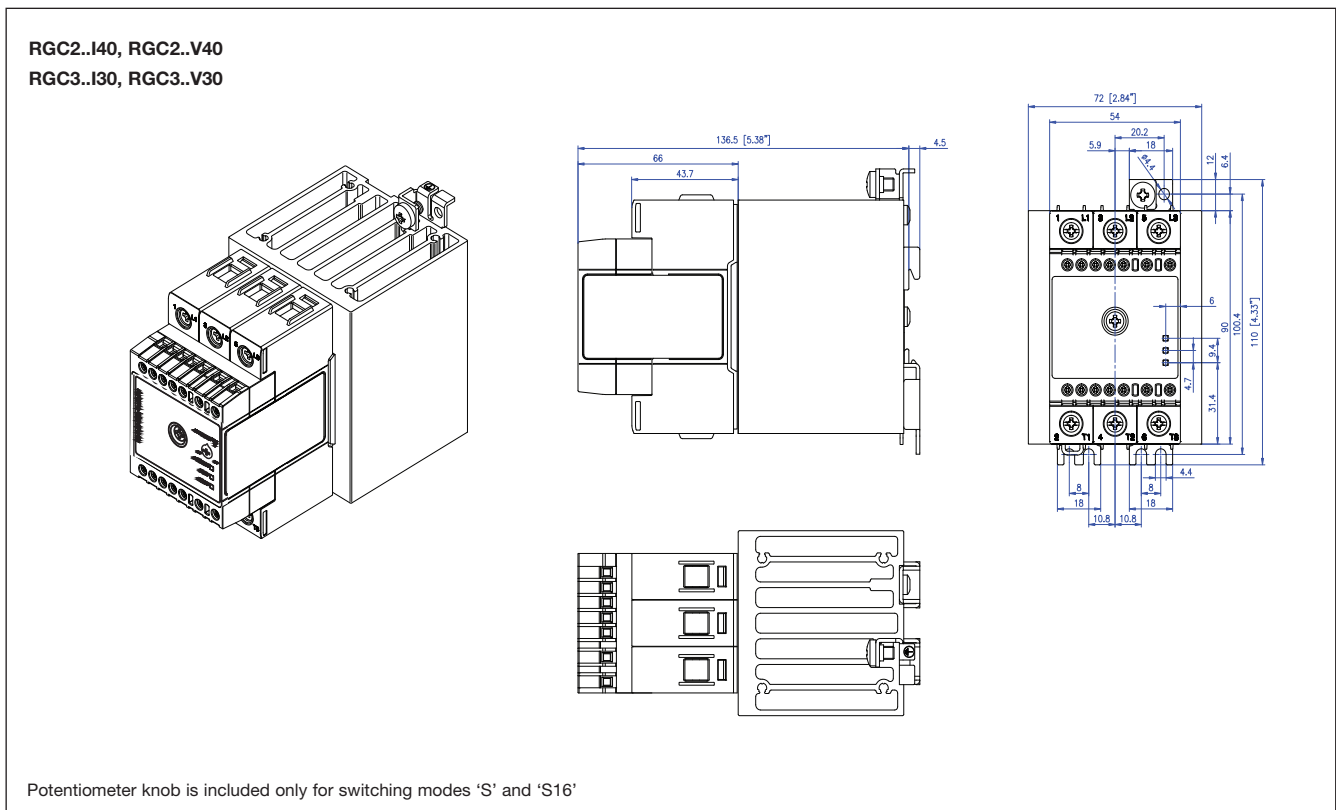
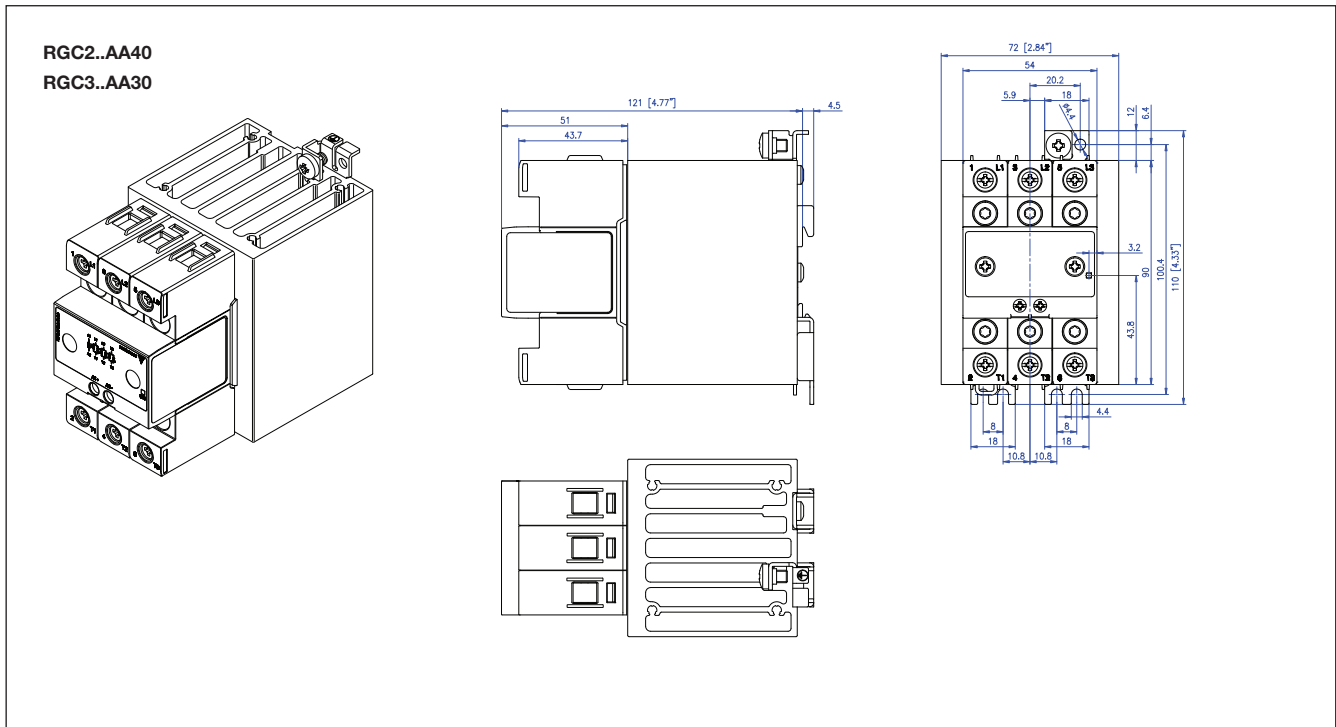





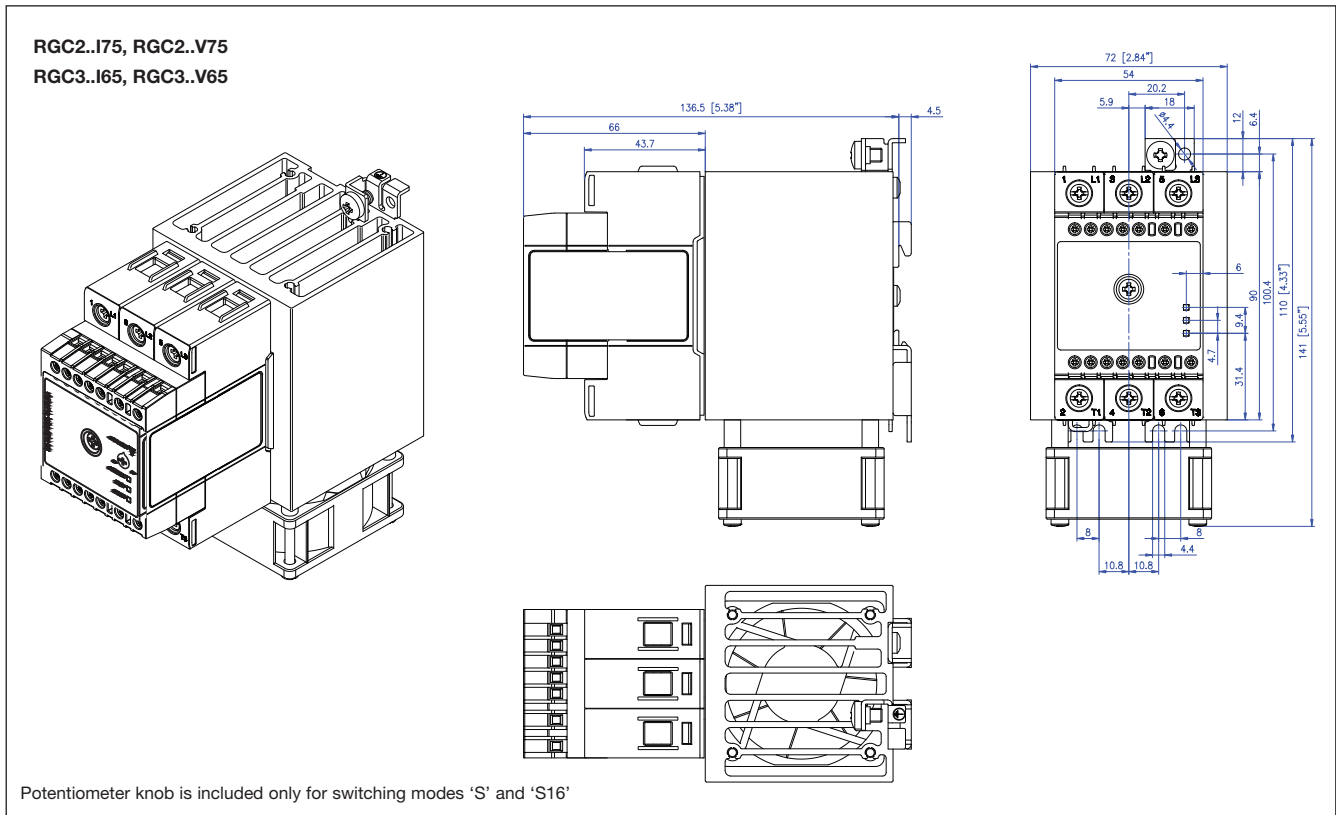





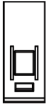
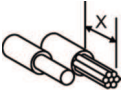

Dimensions in mm. Housing width tolerance +0.5mm, -0mm as per DIN43880.
All other tolerances ±0.5mm

Dimensions

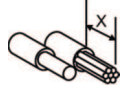

Dimensions in mm. Housing width tolerance +0.5mm, -0mm as per DIN43880.
All other tolerances ±0.5mm

Connection Specifications

| POWER CONNECTIONS | | 1/L1, 3/L2, 5/L3, 2/T1, 4/T2, 6/T3 | | |
|---|---|---|---|---|
| Use 75°C copper (Cu) conductors | | RGC2..15, RGC2..25 RGC3..20 | | RGC2..40, RGC2..75 RGC3..30, RGC3..65 |
| | |  |  |  |
| Stripping length (X) | | 12mm | | 11mm |
| Connection type | | M4 screw with captivated washer | | M5 screw with box clamp |
| Rigid (solid & stranded) UL/cUL rated data |  | 2x 2.5 - 6.0 mm ² 2x 14 - 10 AWG | 1x 2.5 - 6.0 mm ² 1x 14 - 10 AWG | 1x 2.5 - 25 mm ² 1x 14 - 3 AWG |
| Flexible with end sleeve |  | 2x 1.0 - 2.5 mm ² 2x 2.5 - 4.0 mm ² 2x 18 - 14 AWG 2x 14 - 12 AWG | 1x 1.0 - 4.0 mm ² 1x 18 - 12 AWG | 1x 2.5 - 16 mm ² 1x 14 - 6 AWG |
| Flexible without end sleeve |  | 2x 1.0 - 2.5 mm ² 2x 2.5 - 6.0 mm ² 2x 18 - 14 AWG 2x 14 - 10 AWG | 1x 1.0 - 6.0 mm ² 1x 18 - 10 AWG | 1x 4.0 - 25 mm ² 1x 12 - 3 AWG |
| Torque specification |  | Pozidriv 2 UL: 2Nm (17.7 lb-in) IEC: 1.5-2.0Nm (13.3-17.7 lb-in) | | Pozidriv 2 UL: 2.5Nm (22 lb-in) IEC: 2.5-3.0Nm (22-26.6 lb-in) |
| Aperture for termination lug | | 12.3mm | | n/a |
| Protective Earth (PE) connection |  | M5, 1.5Nm (13.3 lb-in) Not provided with SSR. PE connection required when product is intended to be used in Class 1 applications according to EN/IEC 61140 | | |
| CONTROL CONNECTIONS | | A1, A2 | | A1, A2, A3, A4, A5 Us, Uf, 11, 12, 14, C1, C2 |
| Use 75°C copper (Cu) conductors | | RGC..AA.. | | RGC..I.., RGC..V.. |
| | |  |  |  |
| Stripping length (X) | | 8mm | | 8 mm |
| Connection type | | M3 screw with captivated washer | | M3 screw with box clamp |
| Rigid (solid & stranded) UL/cUL rated data |  | 2x 0.5 - 2.5 mm ² 2x 18 - 12 AWG | 1x 0.5 - 2.5 mm ² 1x 18 - 12 AWG | 1x 1.0 - 2.5 mm ² 1x 18 - 12 AWG |
| Flexible with end sleeve |  | 2x 0.5 - 2.5 mm ² 2x 18 - 12 AWG | 1x 0.5 - 2.5 mm ² 1x 18 - 12 AWG | 1x 0.5 - 2.5 mm ² 1x 20 - 12 AWG |
| Torque specification |  | Pozidriv 1 UL: 0.5Nm (4.4 lb-in) IEC: 0.5-0.6Nm (4.4-5.3 lb-in) | | Pozidriv 1 UL: 0.5Nm (4.4 lb-in) IEC: 0.4-0.5Nm (3.5-4.4 lb-in) |

Connection Diagram

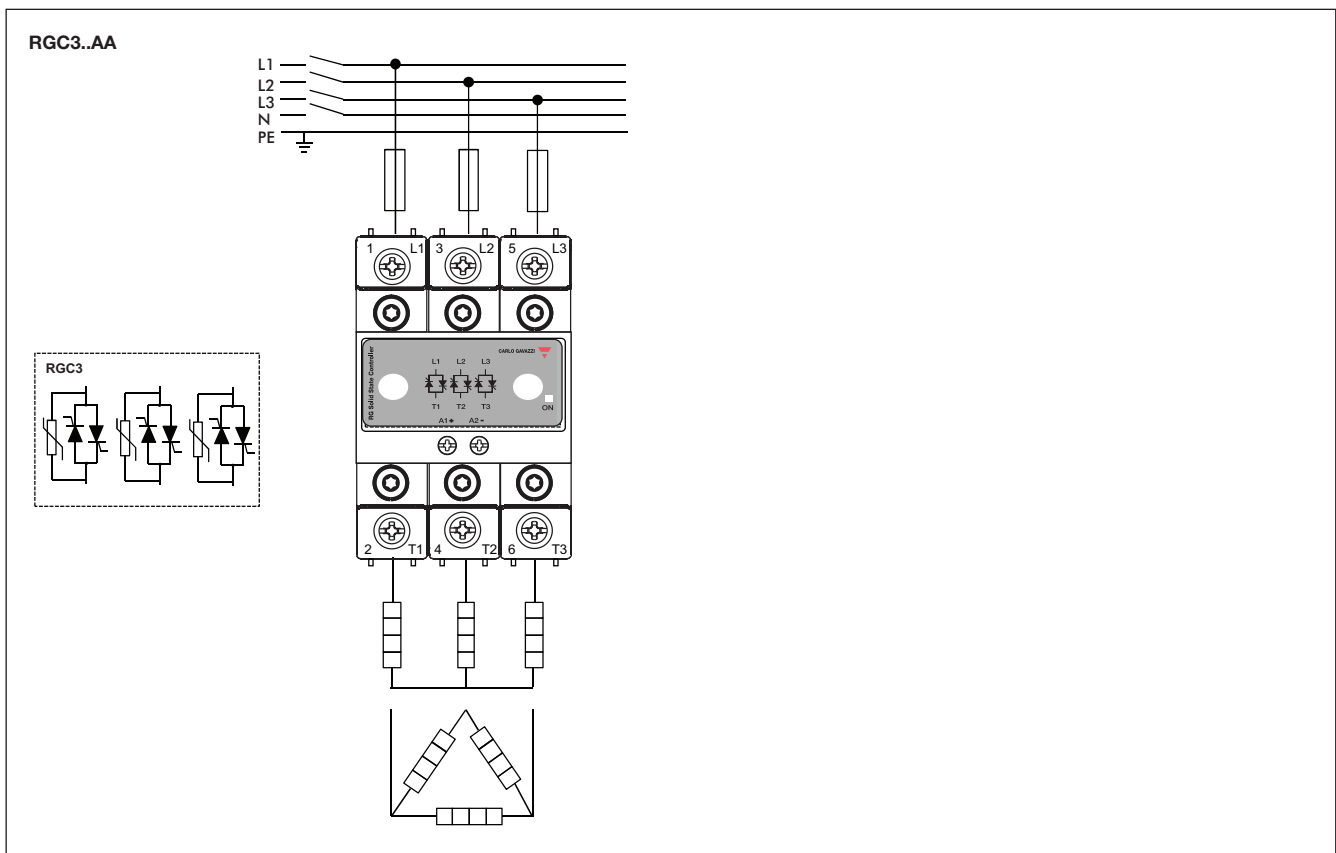
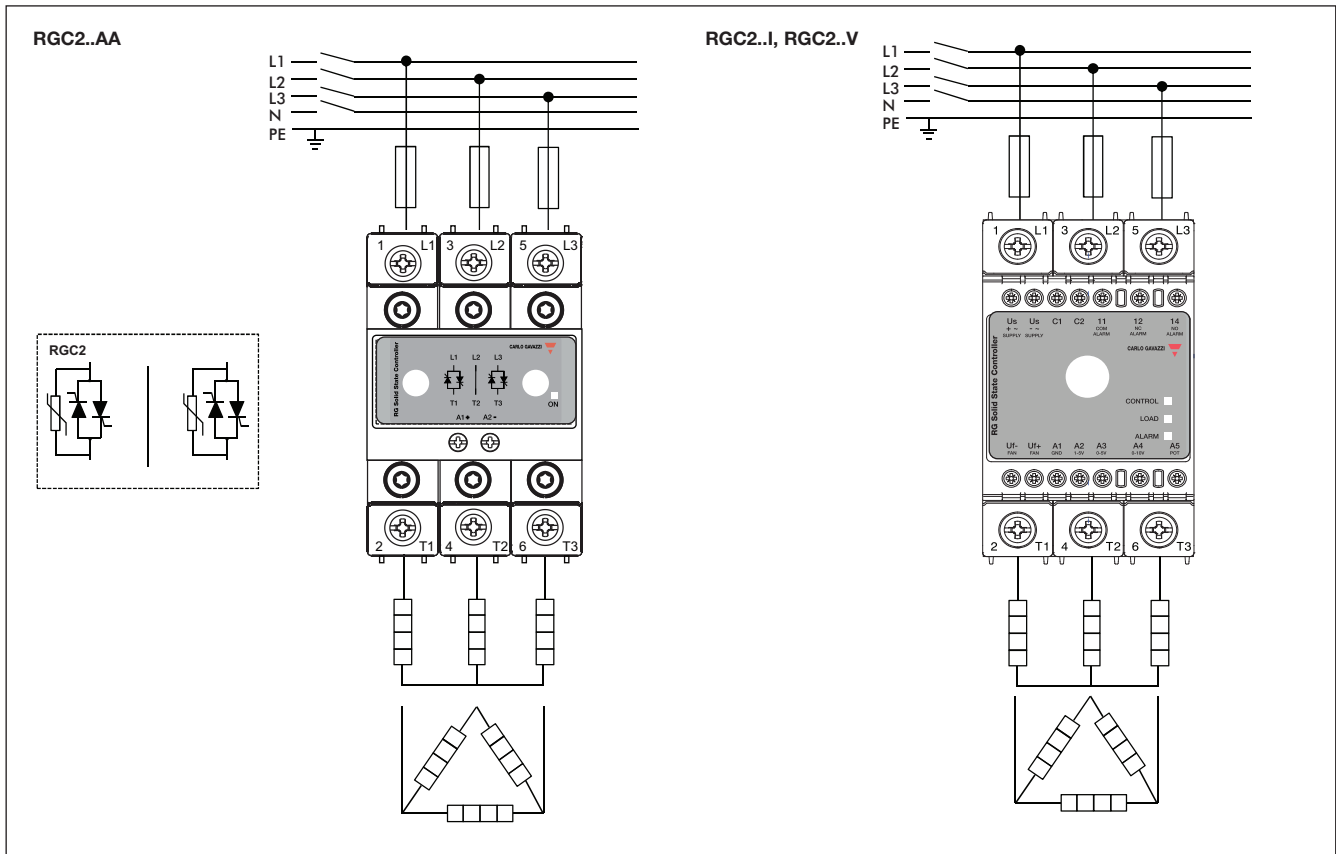

Connection Diagram

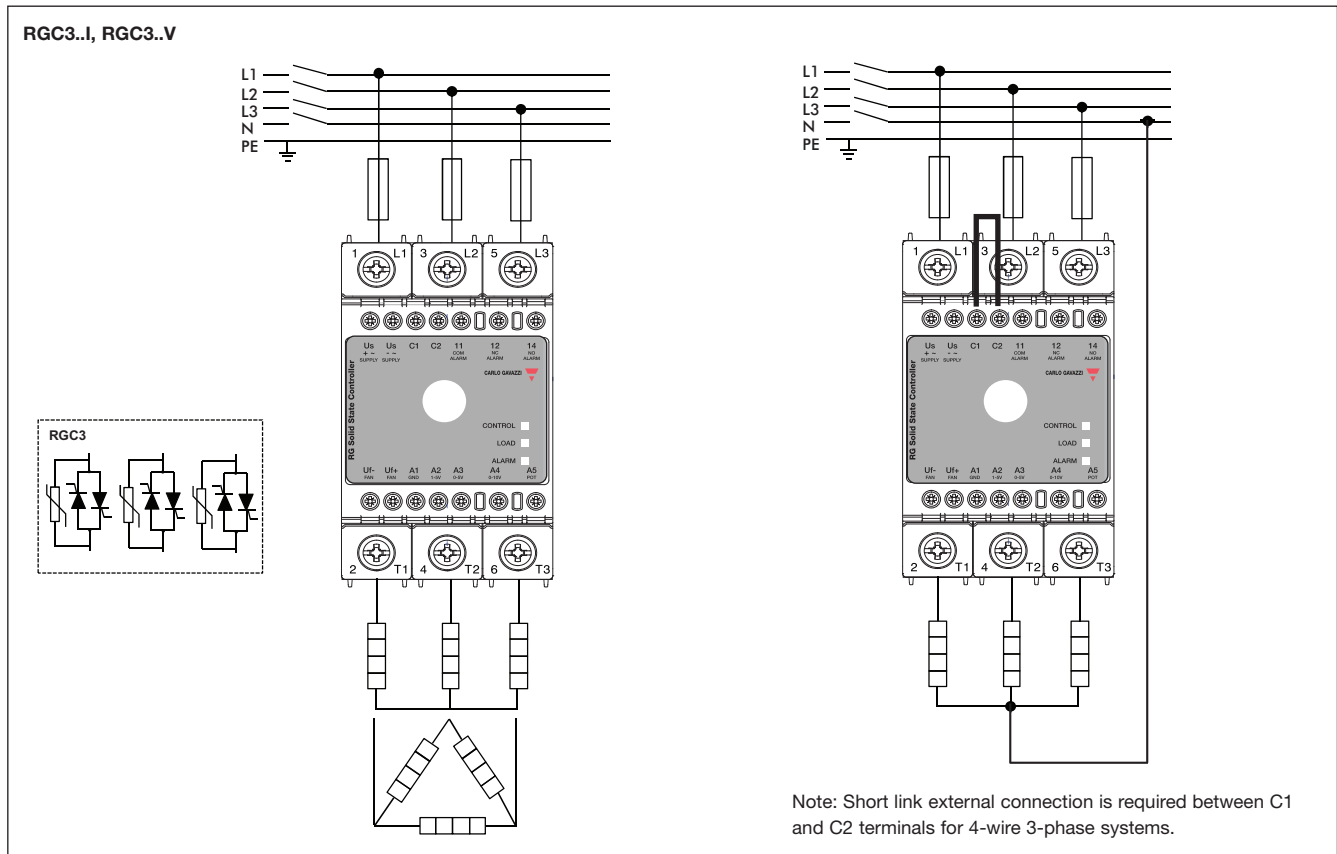

Connection Configuration

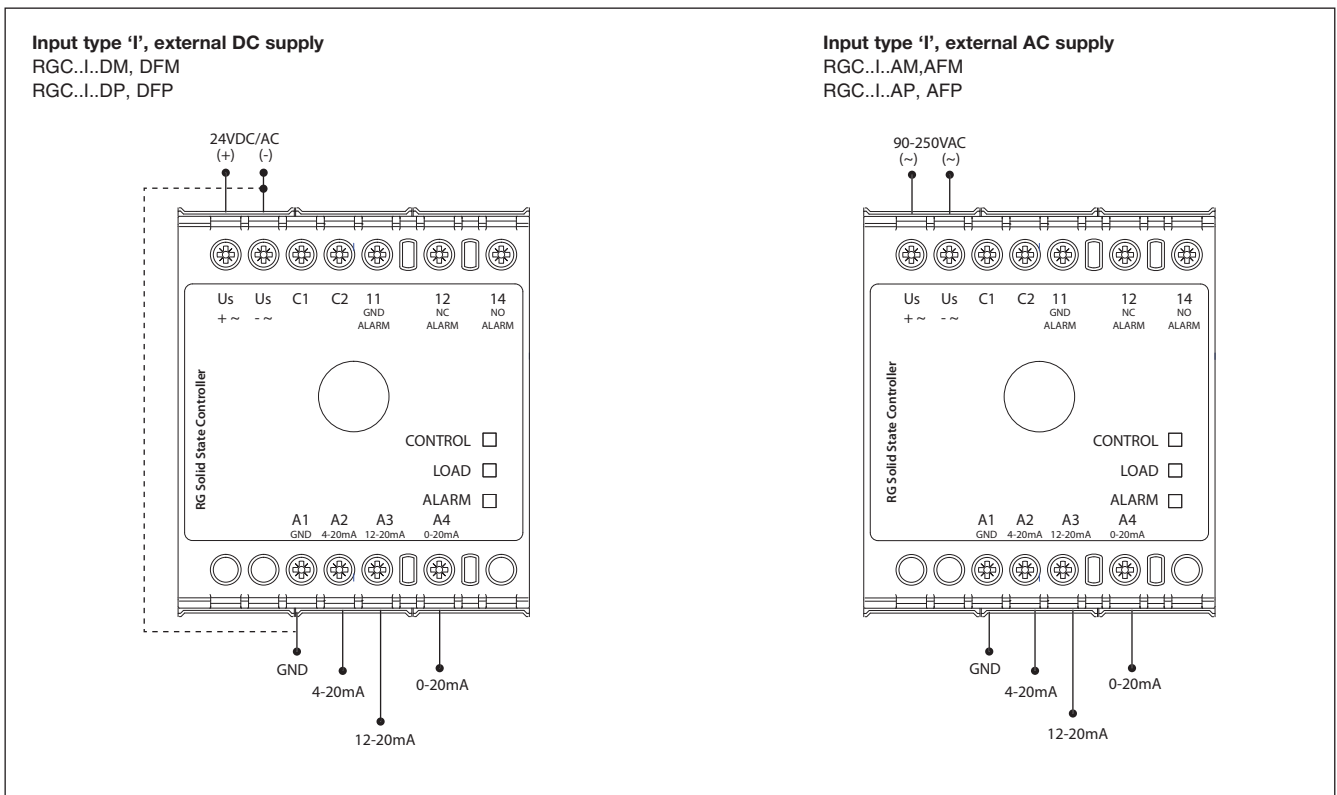

Note: Control input shall be connected either to A1-A2 or A1-A3 or A1-A4 only

Connection Configuration

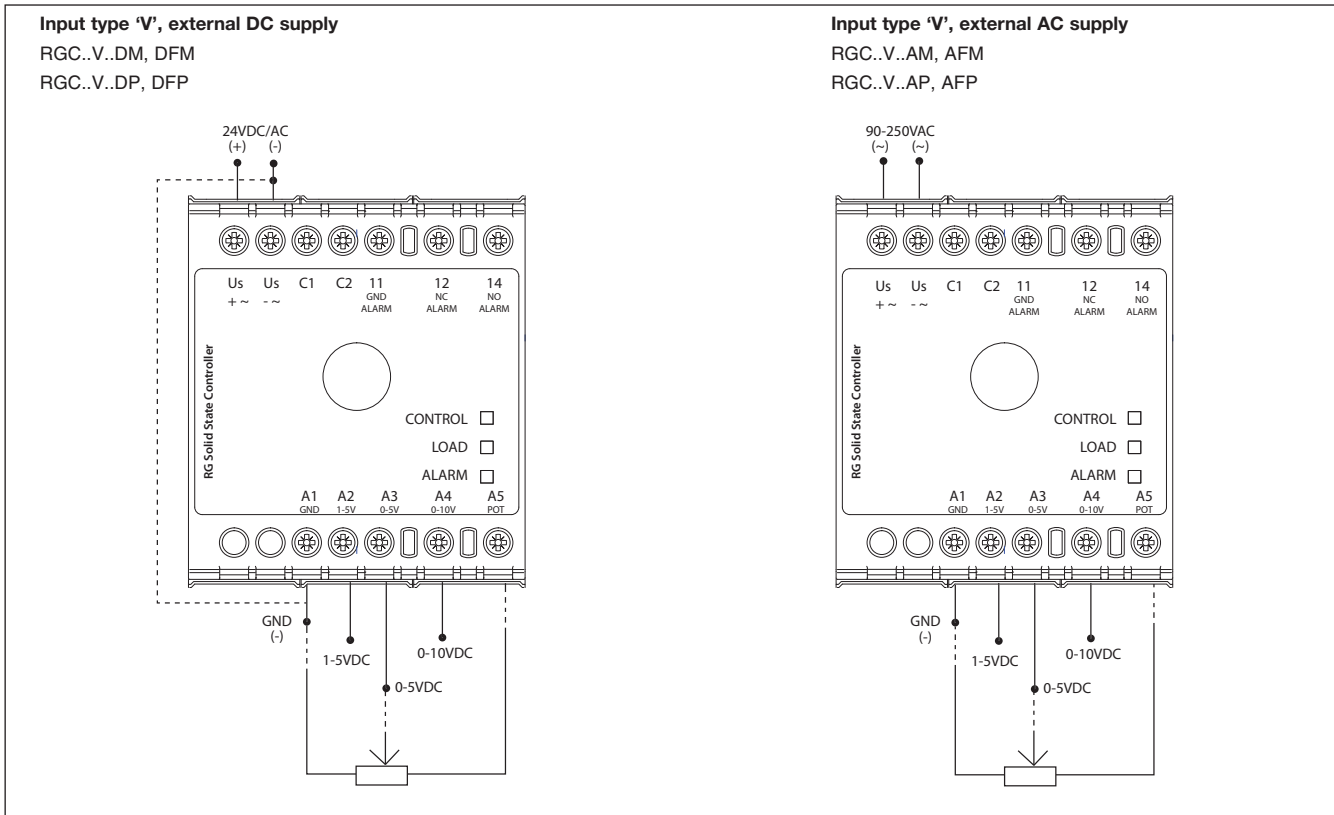

Note: Control input shall be connected either to A1-A2 or A1-A3 or A1-A4 or A1-A3-A5 in case an external potentiometer is used.

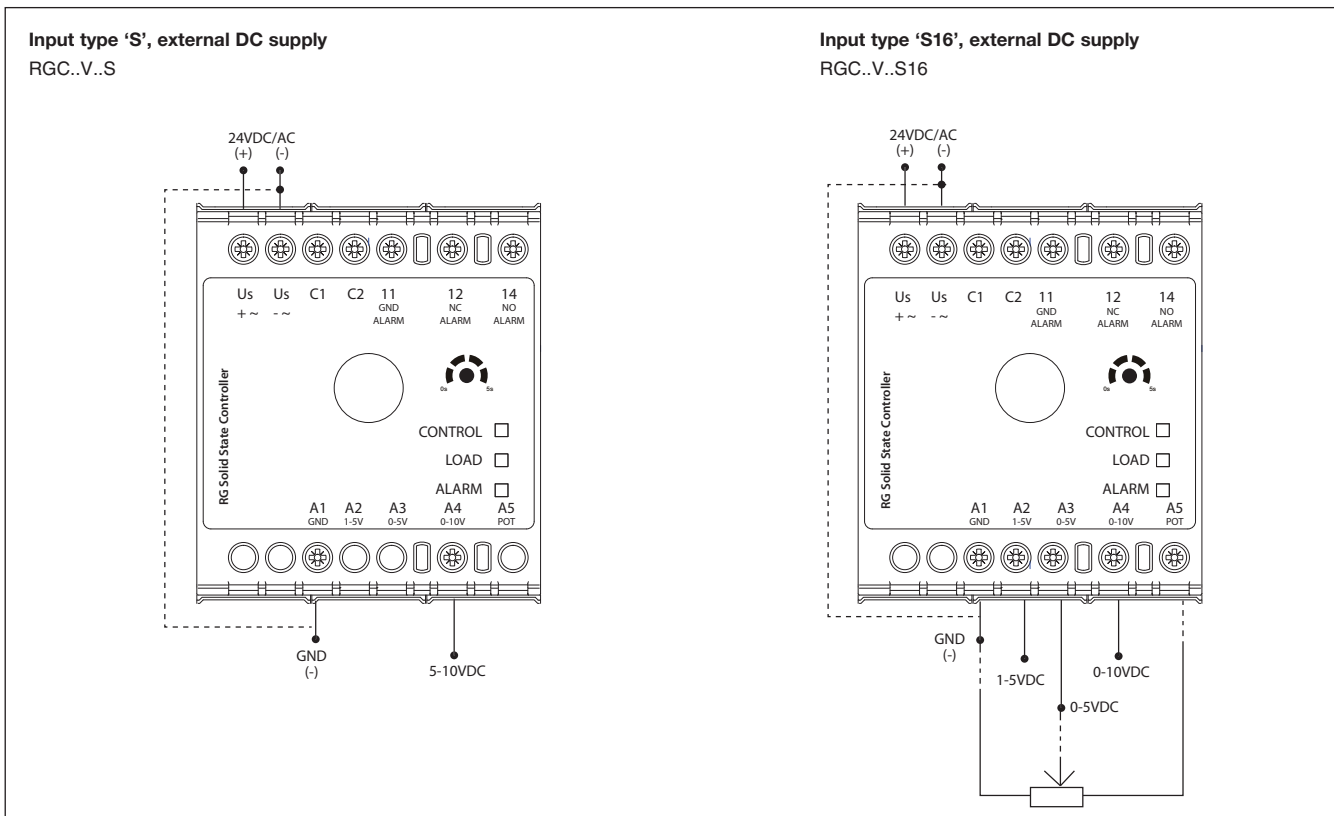

Note: Control input shall be connected to terminals A1-A4 in the case of the RGC3P..S.. In the case of the RGC3P..S16.., the control input shall be connected to either A1-A2 or A1-A3 or A1-A4 or A1-A3-A5 in case an external potentiometer is used.

Mode of Operation

RGC..AA...

The diagram below, Operation Diagram 1, indicates the behaviour of models having input type 'AA' in different operating conditions. The models with this type of input are able to detect abnormal conditions such as **Mains Loss** and **SSR Internal Fault**. The presence of these abnormal conditions is indicated through the green LED which in normal operating conditions is associated with status of the control input. A flashing sequence of this LED is utilised to distinguish such abnormal conditions. Refer to LED Indications section for further details.

Operation Diagram 1:

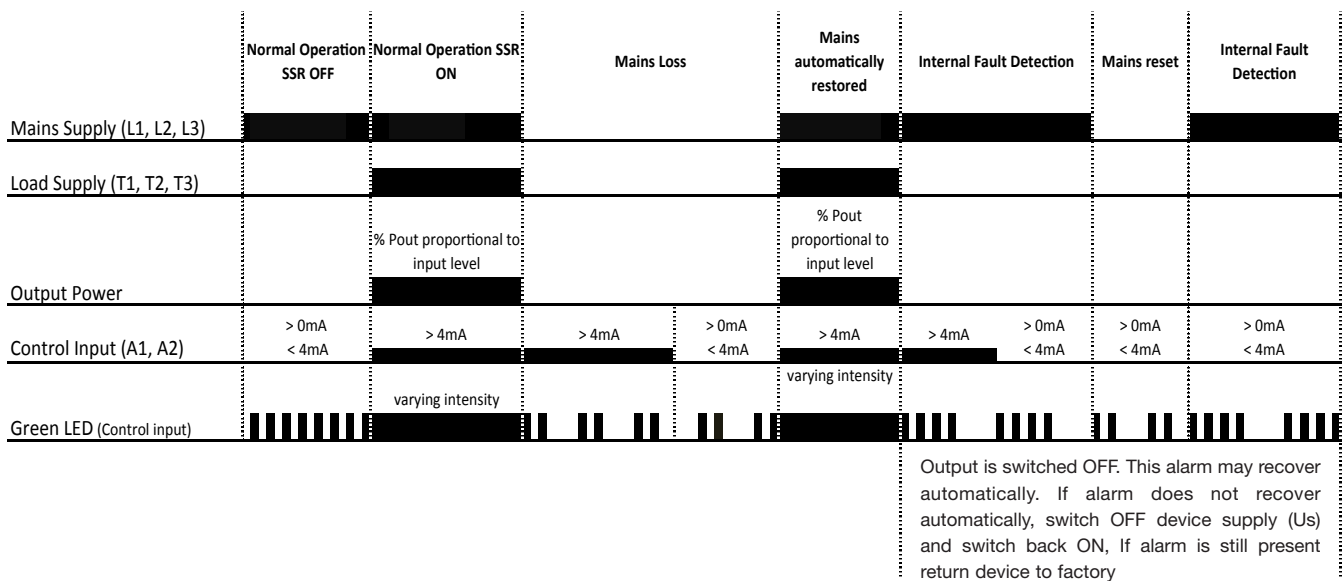

RGC..I, RGC..V.

The versions with input type 'I' or 'V' have integrated system monitoring for the detection of system and also SSR faults. An external supply of 24VDC/AC or 90-250VAC, selectable through part no. configuration, is required for the operation of these models.

In case of a fault condition, an alarm signal is issued through an EMR. A red LED is also used for visual indication with a specific flash rate for easy identification of the alarm type. Refer to section LED Indications for further details. Additionally, a yellow LED is present on the models with 'I' or 'V' input type which gives an indication of the status of the load. This LED is ON every time the SSR output, and hence the load, is in the ON state.

System monitoring is identified with suffix 'P' or 'M' at the end of the RGC part no. The following is a description of the difference between the two suffixes.

Note: Monitoring for system and SSR faults is not active during the soft start function available with models RGC3P60V..S.. and RGC3P60V..S16.

Mode of Operation

1. RGC..I..P, RGC..V..P

The versions with suffix 'P' are available only with switching mode 'E', i.e., phase angle. The detectable alarm conditions in this series are the following:

- Mains Loss (Operation Diagram 2)
- SSR Over Temperature (Operation Diagram 3)
- SSR Internal Fault (Operation Diagram 3)

The following operation diagrams show the behaviour of the RGC..I..P and RGC..V..P under different operating and abnormal conditions.

Operation Diagram 2:

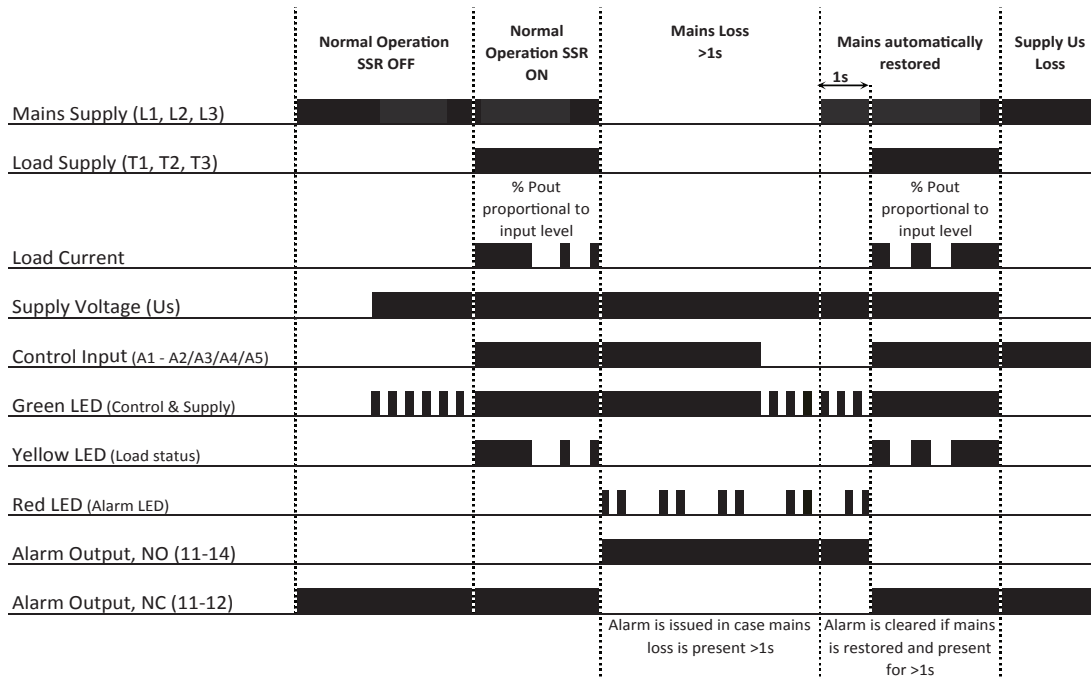

Operation Diagram 3:

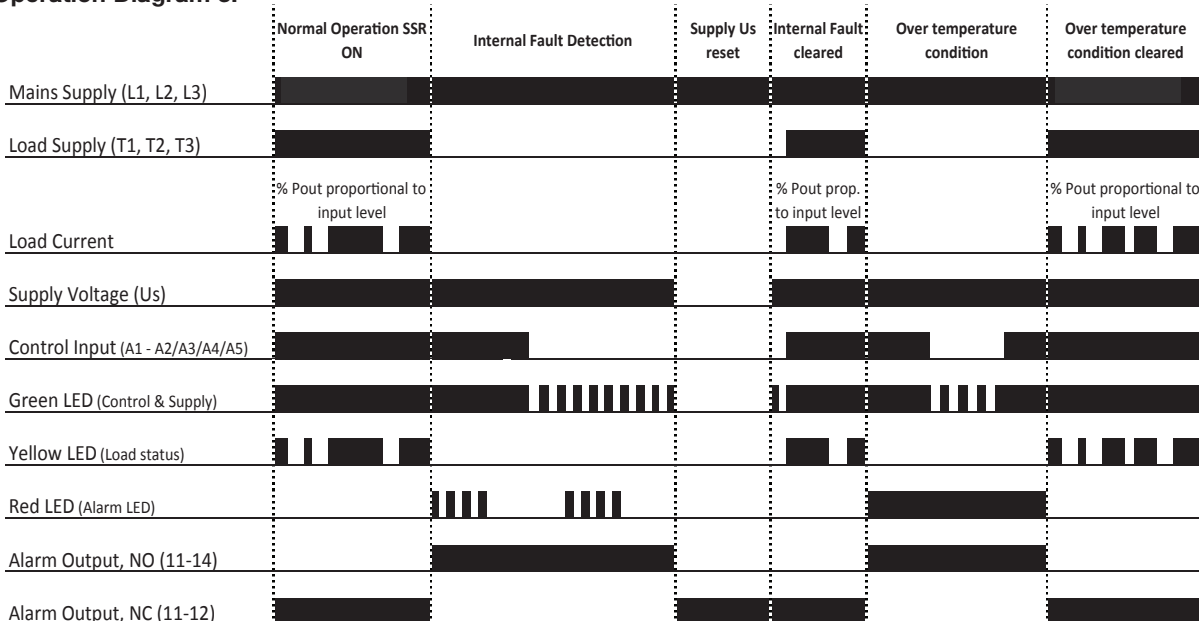

Mode of Operation

2. RGC..I..M, RGC..V..M

Suffix 'M' is available with all switching modes apart from mode 'E'. The detectable alarm conditions for the versions with suffix 'M' are the following:

- Mains Loss (Operation Diagram 2)
- SSR Over Temperature (Operation Diagram 3)
- SSR Internal Fault (Operation Diagram 3)
- Load Loss (Operation Diagram 4)
- SSR Open Circuit (Operation Diagram 4)
- SSR Short Circuit (Operation Diagram 5)

The operation diagrams for Mains Loss, SSR Over Temperature and SSR Internal Fault for the RGC..I..M and RGC..V..M are identical to those of RGC..I..P and RGC..V..P shown in Operation Diagrams 2 and 3. The following diagrams show the behaviour of the RGC..I..M and RGC..V..M under the additional detectable abnormal conditions available only with the 'M' suffix versions.

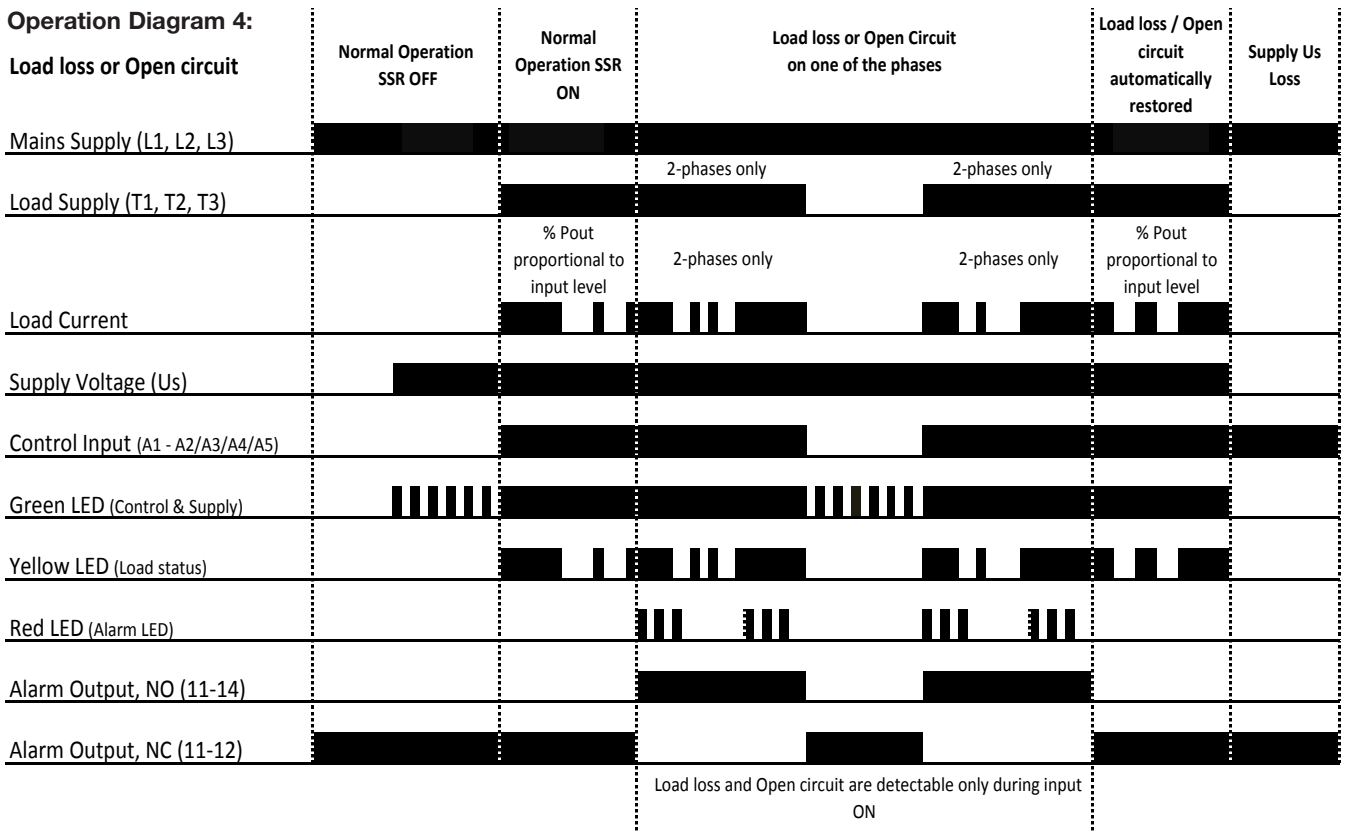

Mode of Operation

Operation diagram 5

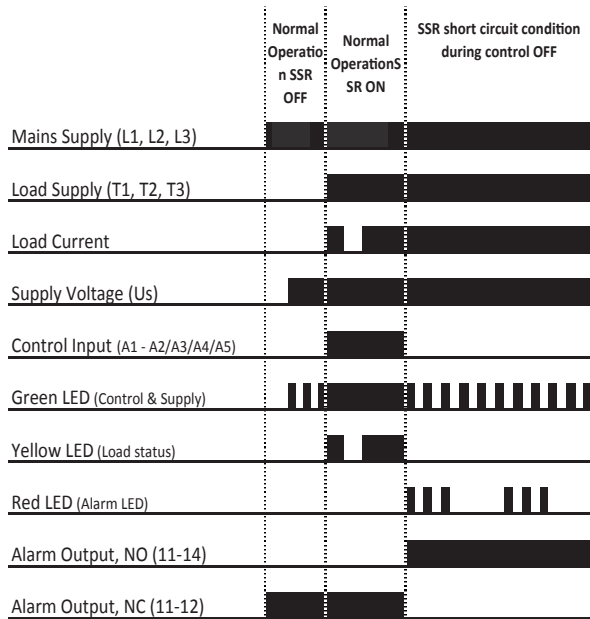



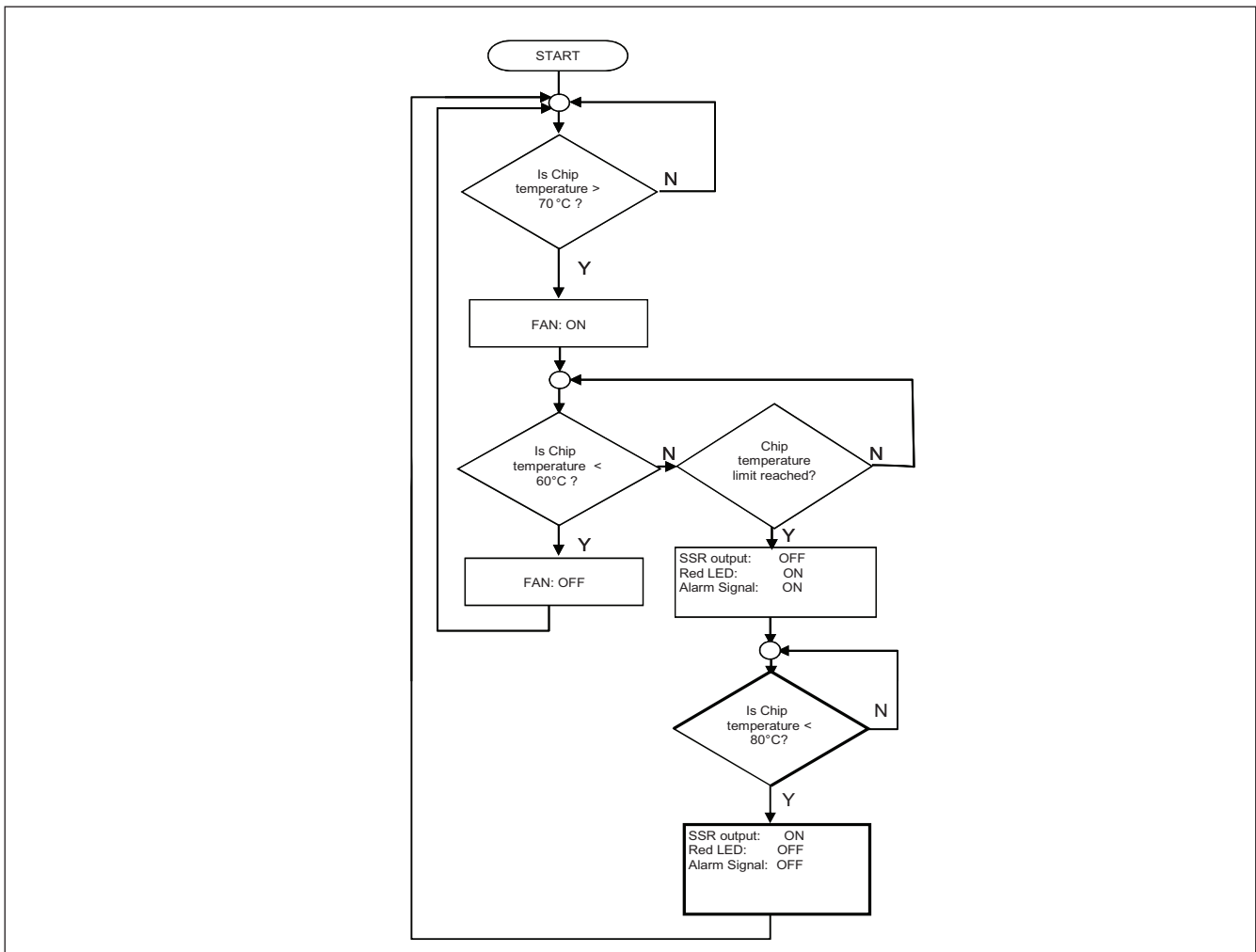



Fan operation for RGC..F..





LED Indications

Green LED

| | RGC..AA.. | RGC..I., RGC..V.. |
|---|--|---|
| Control ON RGC..AA: <4mA flash rate 0.5s ON, 0.5s OFF RGC..I, RGC..V: ON in presence on control input |  |  |
| Control ON RGC..AA: >4mA, varying intensity with input level |  | |
| Internal error: RGC..AA: 4 flashes 0.5s ON, 0.5s OFF with 3s OFF interval RGC..I, RGC..V: not applicable; refer to red LED |  | |
| Mains Loss RGC..AA: 2 flashes 0.5s ON, 0.5s OFF with 3s OFF interval RGC..I, RGC..V: not applicable; refer to red LED |  | |
| Supply ON: (no control input) RGC..AA: not applicable RGC..I, RGC..V: flash rate 0.5s ON, 0.5s OFF | |  |

In case of an internal error, attempt to reset the Mains supply by Switching OFF and back ON to clear the error condition. If this condition is still present, return device to factory.

Red LED

| Flashes | Red LED | Timing Diagram |
|---------|--|--|
| 2 | Mains Loss |  |
| 3 | Monitoring alarm: Load loss, SSR open circuit, SSR short circuit |  |
| 4 | SSR internal fault |  |
| 100% | SSR over temperature |  |

Installation Instructions

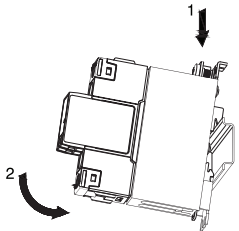

1 ↓
2 ↻

Mounting on DIN rail

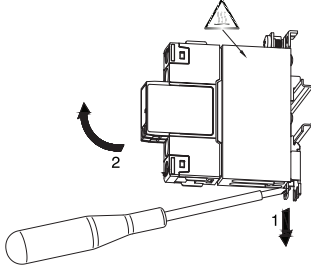

2 ↻
1 ↓

Dismounting from DIN rail

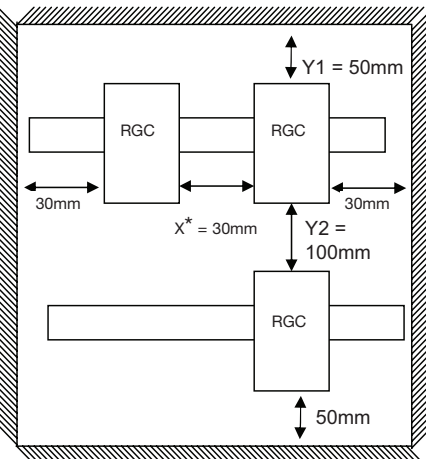

Y1 = 50mm
X* = 30mm
Y2 = 100mm
50mm

* Refer to Current Derating curves at 0mm for 0mm spacing between units

Short Circuit Protection

Protection Co-ordination, Type 1 vs Type 2:

Type 1 protection implies that after a short circuit, the device under test will no longer be in a functioning state. In type 2 co-ordination the device under test will still be functional after the short circuit. In both cases, however the short circuit has to be interrupted. The fuse between enclosure and supply shall not open. The door or cover of the enclosure shall not be blown open. There shall be no damage to conductors or terminals and the conductors shall not separate from terminals. There shall be no breakage or cracking of insulating bases to the extent that the integrity of the mounting of live parts is impaired. Discharge of parts or any risk of fire shall not occur.

The product variants listed in the table hereunder are suitable for use on a circuit capable of delivering not more than 100,000A Symmetrical Amperes, 600Volts maximum when protected by fuses. Tests at 100,000Arms were performed with Class J fuses, fast acting; please refer to the tables below for maximum ratings. Tests with Class J fuses are representative of Class CC fuses.

Co-ordination type 1 (UL508)

| Part No. | Max. fuse size [A] | Class | Short circuit current [kArms] | Voltage [VAC] |
|----------------------|--------------------|---------|-------------------------------|---------------|
| RGC2..15 RGC2..25 | 30 | J or CC | 100 | Max. 600 |
| RGC2..40 | 40 | J | 100 | Max. 600 |
| RGC2..75 | 60 ⁶ | J | 100 | Max. 600 |
| RGC3..20 | 30 | J or CC | 100 | Max. 600 |
| RGC3..30 | 40 | J | 100 | Max. 600 |
| RGC3..65 | 60 ⁶ | J | 100 | Max. 600 |

6: Consult a Carlo Gavazzi sales representative for use of 70A class J fuses

Co-ordination type 2 (EN/IEC 60947-4-3)

| Part No. | Ferraz Shawmut (Mersen) | | Siba | | Short circuit current [kArms] | Voltage [VAC] |
|----------------------|-------------------------|-------------------------|--------------------|---------------|-------------------------------|---------------|
| | Max. fuse size [A] | Part number | Max. fuse size [A] | Part Number | | |
| RGC2..15 RGC2..25 | 40 | 660 URC 14x51/40 | 32 | 50 142 06 32 | 10 | 600 |
| | 40 | 6.9xx gRC URD 22x58/40 | | | 100 | |
| | 40 | 660 URD 22x58/40 | | | | |
| | 40 | A70QS40-4 | | | | |
| RGC2..40 | 63 | 6.9xx gRC URC 14x51/63 | 63 | 50 194 20 63 | 10 | 600 |
| | 63 | 6.9xx gRC URD 22x58/63 | | | 100 | |
| | 60 | A70QS60-4 | | | | |
| RGC2..75 | 100 | 6.9xx gRC URD 22x58/100 | 125 | 50 196 20 125 | 10 | 600 |
| | 100 | 660 URQ 27x60/100 | | | 100 | |
| | 100 | A70QS100-4 | | | | |
| RGC3..20 | 32 | 6.9xx gRC URC 14x51/32 | 32 | 50 142 06 32 | 10 | 600 |
| | 32 | 6.9xx gRC URC 14x51/32 | | | 100 | |
| | 40 | A70QS40-4 | | | | |
| RGC3..30 | 40 | 6.9xx gRC URC 14x51/40 | 40 | 50 194 20 40 | 10 | 600 |
| | 40 | 6.9xx gRC URC 14x51/40 | | | 100 | |
| | 40 | A70QS40-4 | | | | |
| RGC3..65 | 100 | 6.9xx gRC URC 22x58/100 | 125 | 50 196 20 125 | 10 | 600 |
| | 90 | 660 URD 22x58/90 | | | 100 | |
| | 100 | A70QS100-4 | | | | |

Type 2 Protection Coordination with Miniature Circuit Breakers (M.C.Bs)

| Solid State Relay type | ABB Model no. for Z - type M. C. B. (rated current) | ABB Model no. for B - type M. C. B. (rated current) | Wire cross sectional area [mm ²] | Minimum length of Cu wire conductor [m] ⁷ |
|--|---|---|--|--|
| RGC2..15 RGC2..25 RGC3..20 (1,800 A ² s) | S201 - Z10 (10A) | S201 - B4 (4A) | 1.0 | 7.6 |
| | | | 1.5 | 11.4 |
| | | | 2.5 | 19.0 |
| RGC2..40 RGC3..30 (6,600 A ² s) | S201 - Z16 (16A) | S201 - B6 (6A) | 1.0 | 5.2 |
| | | | 1.5 | 7.8 |
| | | | 2.5 | 13.0 |
| | S201 - Z20 (20A) | S201 - B10 (10A) | 4.0 | 20.8 |
| | | | 1.5 | 12.6 |
| | S201 - Z25 (25A) | S201 - B13 (13A) | 2.5 | 25.0 |
| 4.0 | | | 40.0 | |
| RGC2..75 RGC3..65 (15,000 A ² s) | S201 - Z20 (20A) | S201 - B10 (10A) | 1.5 | 4.2 |
| | | | 2.5 | 7.0 |
| | | | 4.0 | 11.2 |
| | S201 - Z32 (32A) | S201 - B16 (16A) | 2.5 | 13 |
| | | | 4.0 | 20.8 |
| | | | 6.0 | 31.2 |
| RGC2..75 RGC3..65 (15,000 A ² s) | S201 - Z25 (25A) | S201 - B16 (16A) | 2.5 | 3.1 |
| | | | 4.0 | 5.0 |
| | | | 6.0 | 7.5 |
| | S201 - Z50 (50A) | S201 - B25 (25A) | 4.0 | 8.0 |
| | | | 6.0 | 12.0 |
| | | | 10.0 | 20.0 |
| | | | 16.0 | 32.0 |
| | S201 - Z63 (63A) | S201 - B32 (32A) | 6.0 | 11.3 |
| | | | 10.0 | 18.8 |
| | | | 16.0 | 30.0 |

7: Between MCB and Load (including return path which goes back to the mains if applicable)

Note: A prospective current of 6kArms and a 230/400V power supply system is assumed for the above suggested specifications. For cables with different cross section than those mentioned above please consult Carlo Gavazzi's Technical Support Group.

Accessories

Fan



Ordering Key

RGC3FAN60

Fan accessory
for RGC2..75 and RGC3..65

Environmental Information

The declaration in this section is prepared in compliance with People's Republic of China Electronic Industry Standard SJ/T11364-2014: Marking for the Restricted Use of Hazardous Substances in Electronic and Electrical Products.

| Part Name | Toxic or Harardous Substances and Elements | | | | | |
|---------------------|--|--------------|--------------|------------------------------|--------------------------------|---------------------------------------|
| | Lead (Pb) | Mercury (Hg) | Cadmium (Cd) | Hexavalent Chromium (Cr(VI)) | Polybrominated biphenyls (PBB) | Polybrominated diphenyl ethers (PBDE) |
| Power Unit Assembly | x | 0 | 0 | 0 | 0 | 0 |

O: Indicates that said hazardous substance contained in homogeneous materials for this part are below the limit requirement of GB/T 26572.

X: Indicates that said hazardous substance contained in one of the homogeneous materials used for this part is above the limit requirement of GB/T 26572.

环境特性

这份申明根据中华人民共和国电子工业标准 SJ/T11364-2014：标注在电子电气产品中限定使用的有害物质

| 零件名称 | 有毒或有害物质与元素 | | | | | |
|------|------------|--------|--------|--------------|-------------|--------------|
| | 铅 (Pb) | 汞 (Hg) | 镉 (Cd) | 六价铬 (Cr(VI)) | 多溴化联苯 (PBB) | 多溴联苯醚 (PBDE) |
| 功率单元 | x | 0 | 0 | 0 | 0 | 0 |

O: 此零件所有材料中含有的该有害物低于GB/T 26572的限定。

X: 此零件某种材料中含有的该有害物高于GB/T 26572的限定。

