



**HESTORE.HU**

elektronikai alkatrész áruház

**EN:** This Datasheet is presented by the manufacturer.

Please visit our website for pricing and availability at [www.hestore.hu](http://www.hestore.hu).

# GXCAS Technology

## Humidity and Temperature Sensor GXHT3X

### DESCRIPTION

GXHT3X is the GXCAS's temperature and humidity sensors. The GXHT3X has increased intelligence, reliability and improved accuracy specifications compared to its predecessor. Its functionality includes enhanced signal processing, two distinctive and user selectable I2C addresses and communication speeds of up to 1 MHz. The DFN package has a footprint of 2.5 x 2.5 mm<sup>2</sup> while keeping a height of 0.9 mm. This allows for integration of the GXHT3X into a great variety of applications. Additionally, the wide supply voltage range of 2.2 V to 5.5 V guarantees compatibility with diverse assembly situations.

### FEATURES

- Fully calibrated and temperature compensated digital output
- Wide supply voltage range, from 2.2 V to 5.5 V
- I2C Interface with communication speeds up to 1MHz and two user selectable addresses
- Typical accuracy of  $\pm 3\%RH$  and  $\pm 0.3\text{ }^\circ C$  for GXHT30
- Typical accuracy of  $\pm 2\%RH$  and  $\pm 0.3\text{ }^\circ C$  for

### GXHT31

- Very fast start-up and measurement time
- Measures Temperatures from 0-100%RH
- Thermometer Resolution is 16 Bits
- Converts Temperature to 16-Bit Digital Word in 2ms
- 8-Pin DFN package

### PIN CONFIGURATIONS

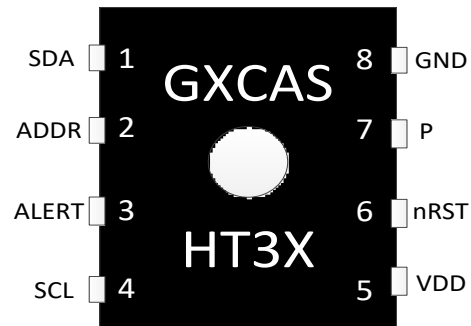

### Content

1	Sensor Performance.....	2
2	Specifications.....	6
3	Pin Assignment.....	8
4	Operation and Communication .....	9
5	Packaging.....	15
6	Shipping Package .....	17
7	Quality.....	18
8	Ordering Information.....	18

# 1 Sensor Performance

## Humidity Sensor Specification

Parameter	Condition	Value	Units
GXHT30 Accuracy tolerance	Typ.	±3	%RH
	Max.	<b>Figure 2</b>	-
GXHT31 Accuracy tolerance	Typ.	±2	%RH
	Max.	<b>Figure 3</b>	-
GXHT35 Accuracy tolerance	Typ.	±1.5	%RH
	Max.	<b>±2</b>	%RH
Repeatability <sup>2</sup>	Low	0.25	%RH
	Medium	0.15	%RH
	High	0.10	%RH
Resolution	Typ.	0.01	%RH
Hysteresis	at 25°C	±1.5	%RH
Specified range	extended <sup>4</sup>	0 to 100	%RH
Response time	τ <sub>63%</sub>	8 <sup>6</sup>	s
Long-term drift	Typ.	<0.25	%RH/y

**Table 1** Humidity sensor specification.

## Temperature Sensor Specification

Parameter	Condition	Value	Units
GXHT30 Accuracy tolerance	typ., 0°C to 65°C	±0.3	°C
GXHT31 Accuracy tolerance	typ., -40°C to 90°C	±0.3	°C
GXHT35 Accuracy tolerance	typ., -40°C to 90°C	±0.2	°C
Repeatability	Low	0.24	°C
	Medium	0.12	°C
	High	0.06	°C
Resolution	Typ.	0.015	°C
Specified Range	-	-40 to 125	°C
Response time	τ <sub>63%</sub>	>2	s
Long Term Drift	max	<0.03	°C/yr

**Table 2** Temperature sensor specification

Humidity Sensor Performance Graphs

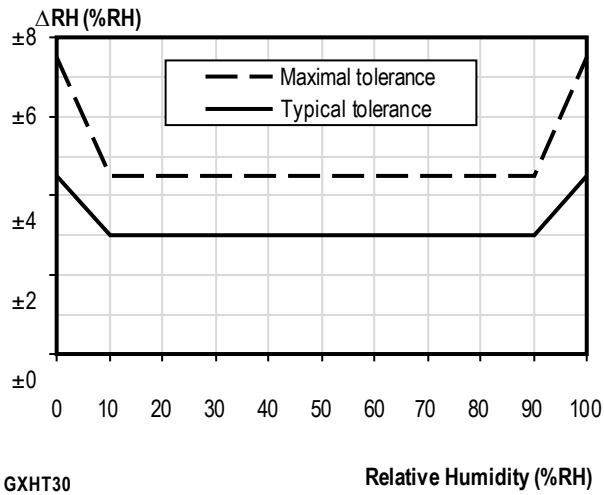

Figure 2 Tolerance of RH at 25°C for GXHT30.

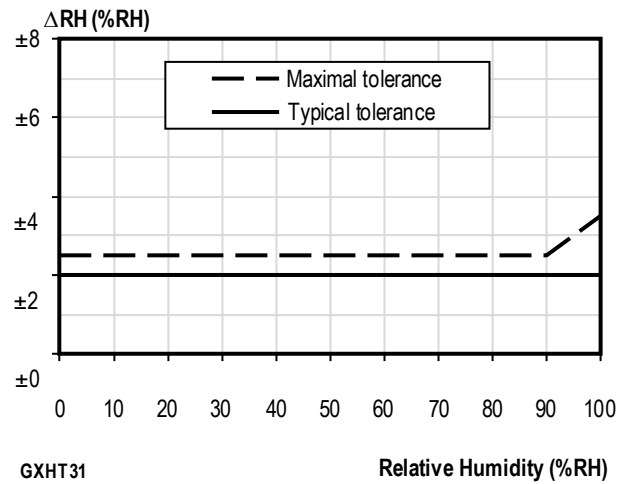

Figure 3 Tolerance of RH at 25°C for GXHT31.

Temperature Sensor Performance Graphs

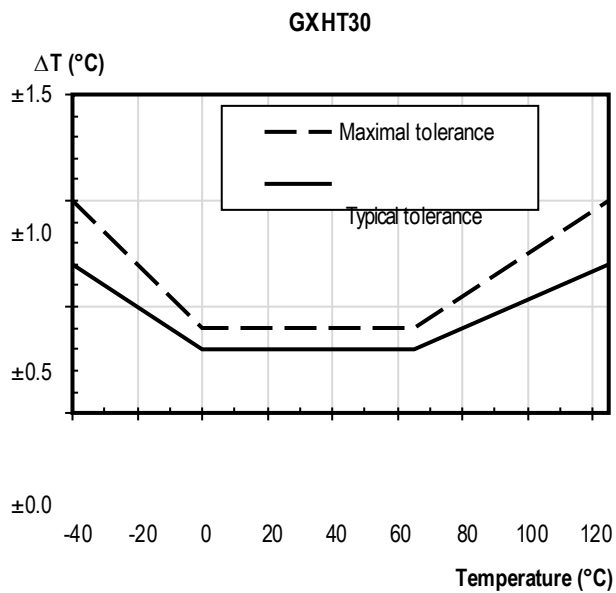

Figure 8 Temperature accuracy of the GXHT30 sensor.

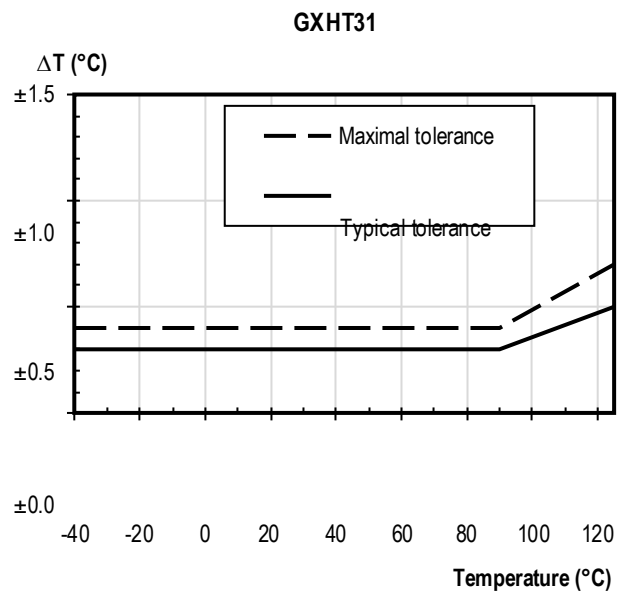

Figure 9 Temperature accuracy of the GXHT31 sensor.

### 1.1 Recommended Operating Condition

The sensor shows best performance when operated within recommended normal temperature and humidity range of 5 °C– 60 °C and 20 %RH – 80 %RH, respectively. Long-term exposure to conditions outside normal range, especially at high humidity, may temporarily offset the RH signal (e.g. +3%RH after 60h kept at >80%RH). After returning into the normal temperature and humidity range the sensor will slowly come back to calibration state by itself. Prolonged exposure to extreme conditions may accelerate ageing. To ensure stable operation of the humidity sensor, the conditions described in the document “GXHT xx Assembly of SMD Packages”, section “Storage and Handling Instructions” regarding exposure to volatile organic compounds have to be met. Please note as well that this does apply not only to transportation and manufacturing, but also to operation of the GXHT 3x.

## 2 Specifications

### 2.1 Electrical Specifications

Parameter	Symbol	Condition	Min.	Typ.	Max.	Units	Comments
Supply voltage	V <sub>DD</sub>		2.4	3.3	5.5	V	
Power-up/down level	V <sub>POR</sub>		2.1	2.3	2.4	V	
Slew rate change of the supply voltage	V <sub>DD,slew</sub>		-	-	20	V/ms	Voltage changes on the V <sub>DD</sub> line between V <sub>DD,min</sub> and V <sub>DD,max</sub> should be slower than the maximum slew rate; faster slew rates may lead to reset;
Supply current	I <sub>DD</sub>	idle state (single shot mode)	-	0.2	2.0	µA	Current when sensor is not performing a measurement during single shot mode
		idle state (periodic data acquisition mode)	-	45	70	µA	Current when sensor is not performing a measurement during periodic data acquisition mode
		Measuring	-	800	1500	µA	Current consumption while sensor is measuring
		Average	-	2	-	µA	Current consumption (operation with one measurement per second at lowest repeatability, single shot mode)
Alert Output driving strength	IOH		0.8x V <sub>DD</sub>	1.5x V <sub>DD</sub>	2.1x V <sub>DD</sub>	mA	See also section 3.5
Heater power	P <sub>Heater</sub>	Heater running	4.5	-	33	mW	Depending on the supply voltage

Table 3 Electrical specifications, valid at 25°C.

## 2.2 Timing Specification for the Sensor System

Parameter	Symbol	Conditions	Min.	Typ.	Max.	Units	Comments
Power-up time	$t_{PU}$	After hard reset, $V_{DD} \geq V_{POR}$	-	0.5	1	ms	Time between $V_{DD}$ reaching $V_{POR}$ and sensor entering idle state
Soft reset time	$t_{SR}$	After soft reset	-	0.5	1	ms	Time between ACK of soft reset command and sensor entering idle state
Duration of reset pulse	$t_{RESETN}$		1	-	-	$\mu s$	See section 3.6
Measurement duration	$t_{MEAS,l}$	Low repeatability	-	2.5	4	ms	The three repeatability modes differ with respect to measurement duration, noise level and energy consumption.
	$t_{MEAS,m}$	Medium repeatability	-	4.5	6	ms	
	$t_{MEAS,h}$	High repeatability	-	12.5	15	ms	

**Table 4** System timing specification, valid from -40 °C to 125 °C and 2.4 V to 5.5 V.

## 2.3 Absolute Minimum and Maximum Ratings

Stress levels beyond those listed in Table 5 may cause permanent damage to the device or affect the reliability of the sensor. These are stress ratings only and functional operation of the device at these conditions is not guaranteed.

Parameter	Rating	Units
Supply voltage $V_{DD}$	-0.3 to 6	V
Max Voltage on pins (pin 1 (SDA); pin 2 (ADDR); pin 3 (ALERT); pin 4 (SCL); pin 6 (nRST))	-0.3 to $V_{DD}+0.3$	V
Input current on any pin	$\pm 100$	mA
Operating temperature range	-40 to 125	°C
Storage temperature range	-40 to 150	°C
ESD HBM (human body model) <sup>9</sup>	4	kV
ESD CDM (charge device model) <sup>10</sup>	750	V

**Table 5** Minimum and maximum ratings; voltage values may only be applied for short time periods.

### 3 Pin Assignment

The GXHT3x comes in a 8-pin DFN package – See Table 6.

Pin	Name	Comments
1	SDA	Serial data; input / output
2	ADDR	Address pin; input; connect to either logic high or low, do not leave floating
3	ALERT	Indicates alarm condition; output; must be left floating if unused
4	SCL	Serial clock; input / output
5	VDD	Supply voltage; input
6	nRESET	Reset pin active low; input; if not used it is recommend to be left floating
7	R	No electrical function; to be connected to VSS
8	VSS	Ground

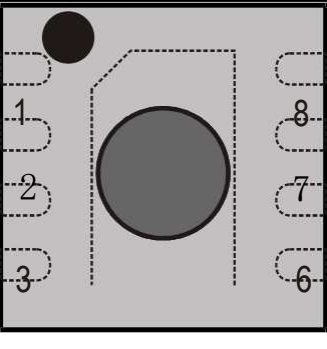

4 \_\_\_\_\_ 5

**Table 6** GXHT3x-DIS pin assignment (transparent top view). Dashed lines are only visible if viewed from below. The die pad is internally connected to VSS.

#### 3.1 Power (VDD, VSS)

The electrical specifications of the GXHT3x-DIS are shown in Table 3. The power supply pins must be decoupled with a 100nF capacitor that shall be placed as close to the sensor as possible – see Figure 11 for a typical application circuit.

#### 3.2 Serial Clock and Serial Data (SCL, SDA)

SCL is used to synchronize the communication between microcontroller and the sensor. The clock frequency can be freely chosen between 0 to 1000 kHz. Commands with clock stretching according to I2C Standard<sup>11</sup> are supported.

The SDA pin is used to transfer data to and from the sensor. Communication with frequencies up to 400 kHz must meet the I2C *Fast Mode*<sup>11</sup> standard. Communication frequencies up to 1Mhz are supported following the specifications given in **Table 20**.

Both SCL and SDA lines are open-drain I/Os with diodes to VDD and VSS. They should be connected to external pull-up resistors (please refer to Figure 11). A device on the I2C bus must only drive a line to ground. The external pull-up resistors (e.g.  $R_p=10\text{ k}\Omega$ ) are required to pull the signal high. For dimensioning resistor sizes please take bus capacity and communication frequency into account (see for example Section 7.1 of NXPs I2C Manual for more details<sup>11</sup>). It should be noted that pull-up resistors may be included in I/O circuits of microcontrollers. It is recommended to wire the sensor according to the application circuit as shown in Figure 11.

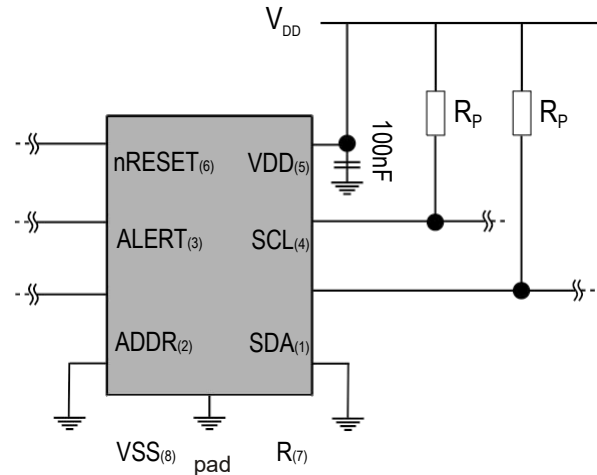

**Figure 11** Typical application circuits. Please note that the positioning of the pins does not reflect the position on the real sensor. This is shown in Table 6.

#### 3.3 Die Pad (center pad)

The die pad or center pad is visible from below and located in the center of the package. It is electrically connected to VSS. Hence electrical considerations do not impose constraints on the wiring of the die pad. However, due to mechanical reasons it is recommended to solder the center pad to the PCB.

#### 3.4 ADDR

Through the appropriate wiring of the ADDR pin the I2C address can be selected (see Table 7 for the respective addresses). The ADDR pin can either be connected to VDD or VSS, or it can be used as a selector pin. This means that the address of the sensor can be changed dynamically during operation by switching the level on the ADDR pin. The only constraint is that the level has to stay constant starting from the I2C start condition until the communication is finished. This allows to connect more than two GXHT3x-DIS onto the same bus. The dynamic switching requires individual ADDR lines to the sensors.

Please note that the I2C address is represented through the 7 MSBs of the I2C read or write header. The LSB switches between read or write header. The wiring for the default address is shown in Table 7 and Figure 11. The ADDR pin must not be left floating. Please note that only the 7 MSBs of the I2C Read/Write header constitute the I2C Address.

GXHT3x-DIS	I2C Address in Hex. representation	Condition
I2C address A	0x44 (default)	ADDR (pin 2) connected to VSS
I2C address B	0x45	ADDR (pin 2) connected to VDD

**Table 7** I2C device addresses.

### 3.5 ALERT

The alert pin may be used to connect to the interrupt pin of a microcontroller. The output of the pin depends on the value of the RH/T reading relative to programmable limits. Its function is explained in a separate application note. If not used, this pin must be left floating. The pin switches high, when alert conditions are met. The maximum driving loads are listed in Table 3. Be aware that self-heating might occur, depending on the amount of current that flows. Self-heating can be prevented if the Alert Pin is only used to switch a transistor.

### 3.6 nRESET

The nReset pin may be used to generate a reset of the sensor. Minimum pulse duration of 1  $\mu$ s is required to reliably trigger a reset of the sensor. Its function is explained in more detail in section 4. If not used it is recommended to leave the pin floating.

## 4 Operation and Communication

The GXHT3x-DIS supports I2C fast mode (and frequencies up to 1000 kHz). Clock stretching can be enabled and disabled through the appropriate user command. For detailed information on the I2C protocol, refer to NXP I2C-bus specification<sup>12</sup>.

All GXHT3x-DIS commands and data are mapped to a 16-bit address space. Additionally, data and commands are protected with a CRC checksum. This increases communication reliability. The 16 bits commands to the sensor already include a 3 bit CRC checksum. Data sent from and received by the sensor is always succeeded by an 8 bit CRC.

In write direction it is mandatory to transmit the checksum, since the GXHT3x-DIS only accepts data if it

is followed by the correct checksum. In read direction it is left to the master to read and process the checksum.

### 4.1 Power-Up and Communication Start

The sensor starts powering-up after reaching the power-up threshold voltage  $V_{POR}$  specified in Table 3. After reaching this threshold voltage the sensor needs the time  $t_{PU}$  to enter idle state. Once the idle state is entered it is ready to receive commands from the master (microcontroller).

Each transmission sequence begins with a START condition (S) and ends with a STOP condition (P) as described in the I2C-bus specification. The stop condition is optional. Whenever the sensor is powered up, but not performing a measurement or communicating, it automatically enters idle state for energy saving. This idle state cannot be controlled by the user.

### 4.2 Starting a Measurement

A measurement communication sequence consists of a START condition, the I2C write header (7-bit I2C device address plus 0 as the write bit) and a 16-bit measurement command. The proper reception of each byte is indicated by the sensor. It pulls the SDA pin low (ACK bit) after the falling edge of the 8th SCL clock to indicate the reception. A complete measurement cycle is depicted in Table 8.

With the acknowledgement of the measurement command, the GXHT3x-DIS starts measuring humidity and temperature.

### 4.3 Measurement Commands for Single Shot Data Acquisition Mode

In this mode one issued measurement command triggers the acquisition of *one data pair*. Each data pair consists of one 16 bit temperature and one 16 bit humidity value (in this order). During transmission each data value is always followed by a CRC checksum, see section 4.4.

In single shot mode different measurement commands can be selected. The 16 bit commands are shown in Table 8. They differ with respect to repeatability (low, medium and high) and clock stretching (enabled or disabled).

The repeatability setting influences the measurement duration and thus the overall energy consumption of the sensor. This is explained in section 2.



Condition		Hex. code	
Repeatability	Clock stretching	MSB	LSB
High	enabled	0x2C	06
Medium			0D
Low			10
High	disabled	0x24	00
Medium			0B
Low			16

e.g. 0x2C06: high repeatability measurement with clock stretching enabled

**Table 8** Measurement commands in single shot mode (Clear blocks are controlled by the microcontroller, grey blocks by the sensor).

#### 4.4 Readout of Measurement Results for Single Shot Mode

After the sensor has completed the measurement, the master can read the measurement results (pair of RH&T) by sending a START condition followed by an I2C read header. The sensor will acknowledge the reception of the read header and send two bytes of data (temperature) followed by one byte CRC checksum and another two bytes of data (relative humidity) followed by one byte CRC checksum. Each byte must be acknowledged by the microcontroller with an ACK condition for the sensor to continue sending data. If the sensor does not receive an ACK from the master after any byte of data, it will not continue sending data.

The sensor will send the temperature value first and then the relative humidity value. After having received the checksum for the humidity value a NACK and stop condition should be sent (see Table 8).

The I2C master can abort the read transfer with a NACK condition after any data byte if it is not interested in subsequent data, e.g. The CRC byte or the second measurement result, in order to save time.

In case the user needs humidity and temperature data but does not want to process CRC data, it is recommended to read the two temperature bytes of data with the CRC byte (without processing the CRC data); after having read the two humidity bytes, the read transfer can be aborted with a with a NACK.

#### No Clock Stretching

When a command without clock stretching has been issued, the sensor responds to a read header with a not acknowledge (NACK), if no data is present.

#### Clock Stretching

When a command with clock stretching has been issued, the sensor responds to a read header with an ACK and subsequently pulls down the SCL line. The SCL line is pulled down until the measurement is complete. As soon as the measurement is complete, the sensor releases the SCL line and sends the measurement results.

#### 4.5 Measurement Commands for Periodic Data Acquisition Mode

In this mode one issued measurement command yields a *stream of data pairs*. Each data pair consists of one 16 bit temperature and one 16 bit humidity value (in this order).

In periodic mode different measurement commands can be selected. The corresponding 16 bit commands are shown in Table 9. They differ with respect to repeatability (low, medium and high) and data acquisition frequency (0.5, 1, 2, 4 & 10 measurements per second, mps). Clock stretching cannot be selected in this mode.

The data acquisition frequency and the repeatability setting influence the measurement duration and the current consumption of the sensor. This is explained in section 2 of this datasheet.

If a measurement command is issued, while the sensor is busy with a measurement (measurement durations see Table 4), it is recommended to issue a break command first (see section 4.8). Upon reception of the break command the sensor will finish the ongoing measurement and enter the single shot mode.

Condition		Hex. code	
Repeatability	mps	MSB	LSB
High	0.5	0x20	32
Medium			24
Low			2F
High	1	0x21	30
Medium			26
Low			2D
High	2	0x22	36
Medium			20
Low			2B
High	4	0x23	34
Medium			22
Low			29
High	10	0x27	37
Medium			21
Low			2A

e.g. 0x2130: 1 high repeatability mps - measurement per second

**Table 9** Measurement commands for periodic data acquisition mode (Clear blocks are controlled by the microcontroller, grey blocks by the sensor). N.B.: At the highest mps setting self-heating of the sensor might occur.

### 4.6 Readout of Measurement Results for Periodic Mode

Transmission of the measurement data can be initiated through the fetch data command shown in Table 10. If no measurement data is present the I2C read header is responded with a NACK (Bit 9 in Table 10) and the communication stops. After the read out command fetch data has been issued, the data memory is cleared, i.e. no measurement data is present.

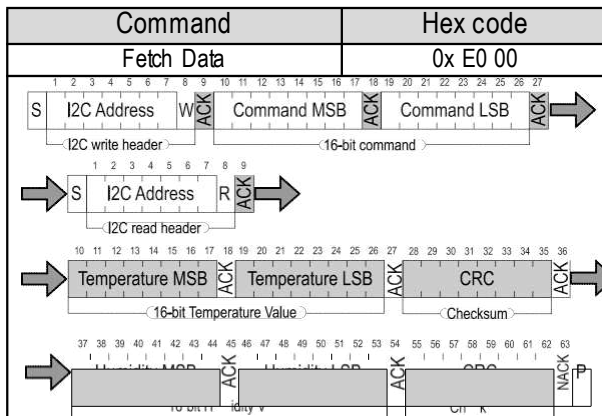
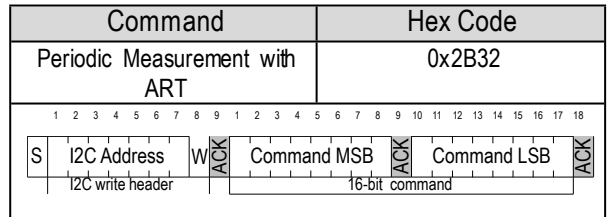

**Table 10** Fetch Data command (Clear blocks are controlled by the microcontroller, grey blocks by the sensor).

### 4.7 ART Command

The ART (accelerated response time) feature can be activated by issuing the command in Table 11. After issuing the ART command the sensor will start acquiring data with a frequency of 4Hz.

The ART command is structurally similar to any other command in Table 9. Hence section 4.5 applies for starting a measurement, section 4.6 for reading out data and section 4.8 for stopping the periodic data acquisition.



**Table 11** Command for a periodic data acquisition with the ART feature (Clear blocks are controlled by the microcontroller, greyblocks by the sensor).

### 4.8 Break command / Stop Periodic Data Acquisition Mode

The periodic data acquisition mode can be stopped using the break command shown in Table 12. It is recommended to stop the periodic data acquisition prior to sending another command (except Fetch Data command) using the break command. Upon reception of the break command the sensor enters the single shot mode, after finishing the ongoing measurement. This can take up to 15ms, depending on the selected repeatability.

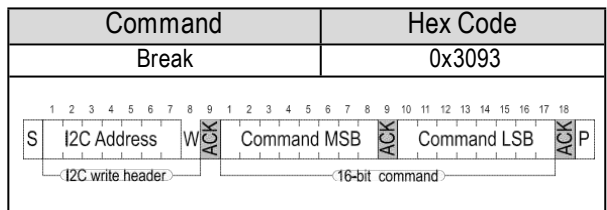

**Table 12** Break command (Clear blocks are controlled by the microcontroller, grey blocks by the sensor).

### 4.9 Reset

A system reset of the GXH3x-DIS can be generated externally by issuing a command (soft reset) or by sending a pulse to the dedicated reset pin (nReset pin). Additionally, a system reset is generated internally during power-up. During the reset procedure the sensor will not process commands.

In order to achieve a full reset of the sensor without removing the power supply, it is recommended to use the nReset pin of the GXHT3x-DIS.

**Interface Reset**

If communication with the device is lost, the following signal sequence will reset the serial interface: While leaving SDA high, toggle SCL nine or more times. This must be followed by a Transmission Start sequence preceding the next command. This sequence resets the interface only. The status register preserves its content.

**Soft Reset / Re-Initialization**

The GXHT3x-DIS provides a soft reset mechanism that forces the system into a well-defined state without removing the power supply. When the system is in idle state the soft reset command can be sent to the GXHT3x-DIS. This triggers the sensor to reset its system controller and reloads calibration data from the memory. In order to start the soft reset procedure the command as shown in Table 13 should be sent.

It is worth noting that the sensor reloads calibration data prior to every measurement by default.

Command	Hex Code
Soft Reset	0x30A2

**Table 13** Soft reset command (Clear blocks are controlled by the microcontroller, grey blocks by the sensor).

**Reset through General Call**

Additionally, a reset of the sensor can also be generated using the “general call” mode according to I2C -bus specification<sup>12</sup>. This generates a reset which is functionally identical to using the nReset pin. It is important to understand that a reset generated in this way is not device specific. All devices on the same I2C bus that support the general call mode will perform a reset. Additionally, this command only works when the sensor is able to process I2C commands. The appropriate command consists of two bytes and is shown in Table 14.

**Reset through the nReset Pin**

Pulling the nReset pin low (see Table 6) generates a reset similar to a hard reset. The nReset pin is internally connected to VDD through a pull-up resistor and hence active low. The nReset pin has to be pulled low for a minimum of 1 μs to generate a reset of the sensor.

Command	Code
Address byte	0x00
Second byte	0x06
Reset command using the general call address	0x0006

**Table 14** Reset through the general call address (Clear blocks are controlled by the microcontroller, grey blocks by the sensor).

**Hard Reset**

A hard reset is achieved by switching the supply voltage to the VDD Pin off and then on again. In order to prevent powering the sensor over the ESD diodes, the voltage to pins 1 (SDA), 4 (SCL) and 2 (ADDR) also needs to be removed.

**4.10 Heater**

The heater can be switched on and off by command, see table below. The status is listed in the status register. After a reset the heater is disabled (default condition).

Command	Hex Code	
	MSB	LSB
Heater Enable	0x30	6D
Heater Disabled		66

**Table 15** Heater command (Clear blocks are controlled by the microcontroller, grey blocks by the sensor).

**4.11 Status Register**

The status register contains information on the operational status of the heater, the alert mode and on the execution status of the last command and the last write sequence. The command to read out the status register is shown in Table 16 whereas a description of the content can be found in Table 17.

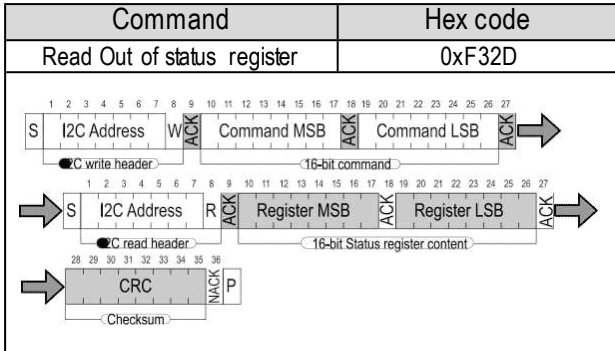

**Table 16** Command to read out the status register (Clear blocks are controlled by the microcontroller, grey blocks by the sensor).

Bit	Field description	Default value
15	Alert pending status '0': no pending alerts '1': at least one pending alert	'1'
14	Reserved	'0'
13	Heater status '0' : Heater OFF '1' : Heater ON	'0'
12	Reserved	'0'
11	RH tracking alert '0' : no alert '1' . alert	'0'
10	T tracking alert '0' : no alert '1' . alert	'0'
9:5	Reserved	'xxxxx'
4	System reset detected '0': no reset detected since last 'clear status register' command '1': reset detected (hard reset, soft reset command or supply fail)	'1'
3:2	Reserved	'00'
1	Command status '0': last command executed successfully '1': last command not processed. It was either invalid, failed the integrated command checksum	'0'
0	Write data checksum status '0': checksum of last write transfer was correct '1': checksum of last write transfer failed	'0'

**Table 17** Description of the status register.

### Clear Status Register

All flags (Bit 15, 11, 10, 4) in the status register can be cleared (set to zero) by sending the command shown in Table 18.

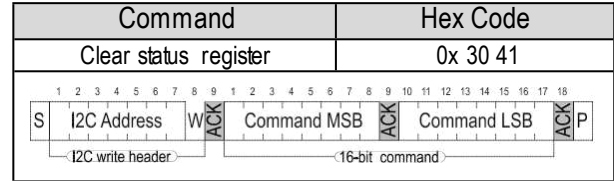

**Table 18** Command to clear the status register (Clear blocks are controlled by the microcontroller, grey blocks by the sensor).

### 4.12 Checksum Calculation

The 8-bit CRC checksum transmitted after each data word is generated by a CRC algorithm. Its properties are displayed in Table 19. The CRC covers the contents of the two previously transmitted data bytes. To calculate the checksum only these two previously transmitted data bytes are used.

Property	Value
Name	CRC-8
Width	8 bit
Protected data	read and/or write data
Polynomial	0x31 ( $x^8 + x^5 + x^4 + 1$ )
Initialization	0xFF
Reflect input	False
Reflect output	False
Final XOR	0x00
Examples	CRC (0xBEEF) = 0x92

**Table 19** I2C CRC properties.

### 4.13 Conversion of Signal Output

Measurement data is always transferred as 16-bit values (unsigned integer). These values are already linearized and compensated for temperature and supply voltage effects. Converting those raw values into a physical scale can be achieved using the following formulas.

Relative humidity conversion formula (result in %RH):

$$RH = 100 \cdot \frac{S_{RH}}{2^{16} - 1}$$

Temperature conversion formula (result in °C & °F):

$$T [^{\circ}C] = -45 + 175 \cdot \frac{S_T}{2^{16} - 1}$$

$$T [^{\circ}F] = -49 + 315 \cdot \frac{S_T}{2^{16} - 1}$$

$S_{RH}$  and  $S_T$  denote the raw sensor output for humidity and temperature, respectively. The formulas work only correctly when  $S_{RH}$  and  $S_T$  are used in decimal representation.

### 4.14 Communication Timing

Parameter	Symbol	Conditions	Min.	Typ.	Max.	Units	Comments
SCL clock frequency	$f_{SCL}$		0	-	1000	kHz	
Hold time (repeated) START condition	$t_{HD,STA}$	After this period, the first clock pulse is generated	0.24	-	-	$\mu s$	
LOW period of the SCL clock	$t_{LOW}$		0.65	-	-	$\mu s$	
HIGH period of the SCL clock	$t_{HIGH}$		0.26	-	-	$\mu s$	
SDA hold time	$t_{HD,DAT}$		0	-	250	ns	Transmitting data
			0	-	-	ns	Receiving data
SDA set-up time	$t_{SU,DAT}$		100	-	-	ns	
SCL/SDA rise time	$t_r$		-	-	300	ns	
SCL/SDA fall time	$t_f$		-	-	300	ns	
SDA valid time	$t_{VD,DAT}$		-	-	0.9	$\mu s$	
Set-up time for a repeated START condition	$t_{SU,STA}$		0.6	-	-	$\mu s$	
Set-up time for STOP condition	$t_{SU,STO}$		0.6	-	-	$\mu s$	
Capacitive load on bus line	CB		-	-	400	pF	
Low level input voltage	$V_{IL}$		-0.5	-	$0.3 \times V_{DD}$	V	
High level input voltage	$V_{IH}$		$0.7 \times V_{DD}$	-	$1 \times V_{DD}$	V	
Low level output voltage	$V_{OL}$	3 mA sink current	-	-	0.66	V	

**Table 20** Communication timing specifications for I2C fm (fast mode), specifications are at 25°C and typical VDD. The numbers above are values according to the I2C Specification (UM10204, Rev. 6, April 4, 2014).

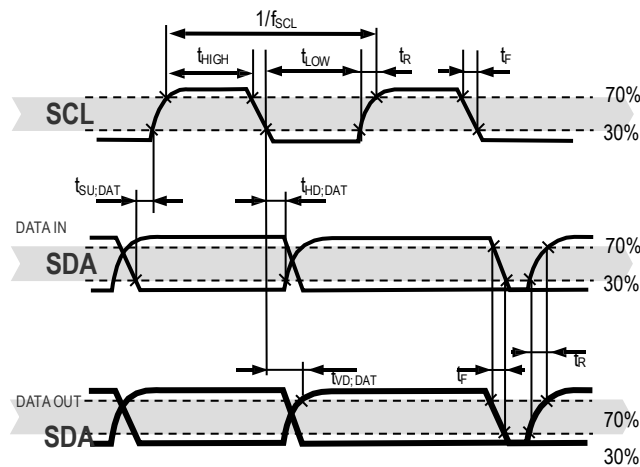

**Figure 12** Timing diagram for digital input/output pads. SDA directions are seen from the sensor. Bold SDA lines are controlled by the sensor, plain SDA lines are controlled by the micro-controller. Note that SDA valid read time is triggered by falling edge of preceding toggle.

## 5 Packaging

### 5.1 Package Outline

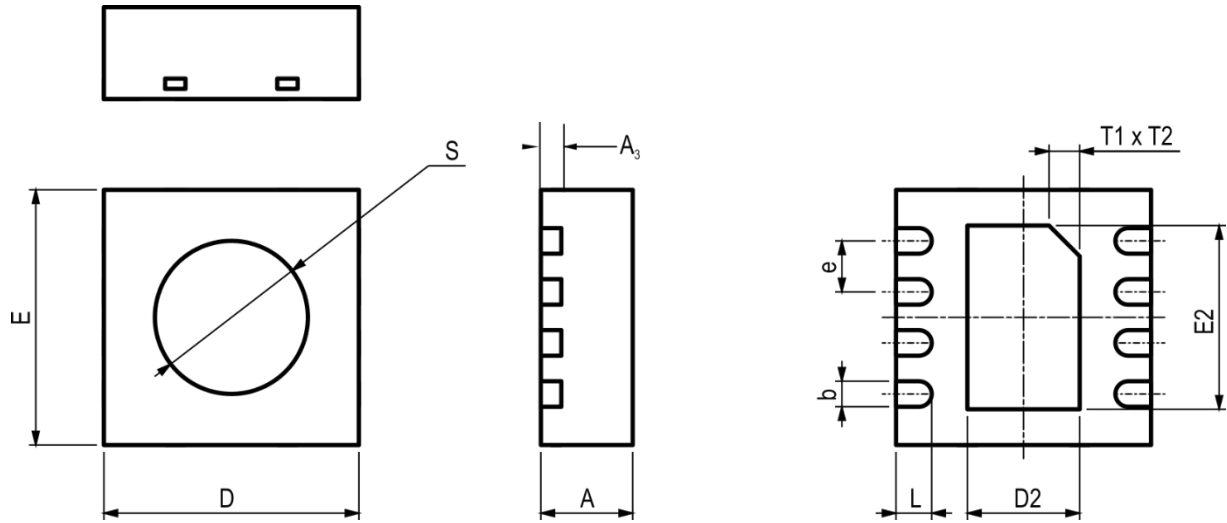
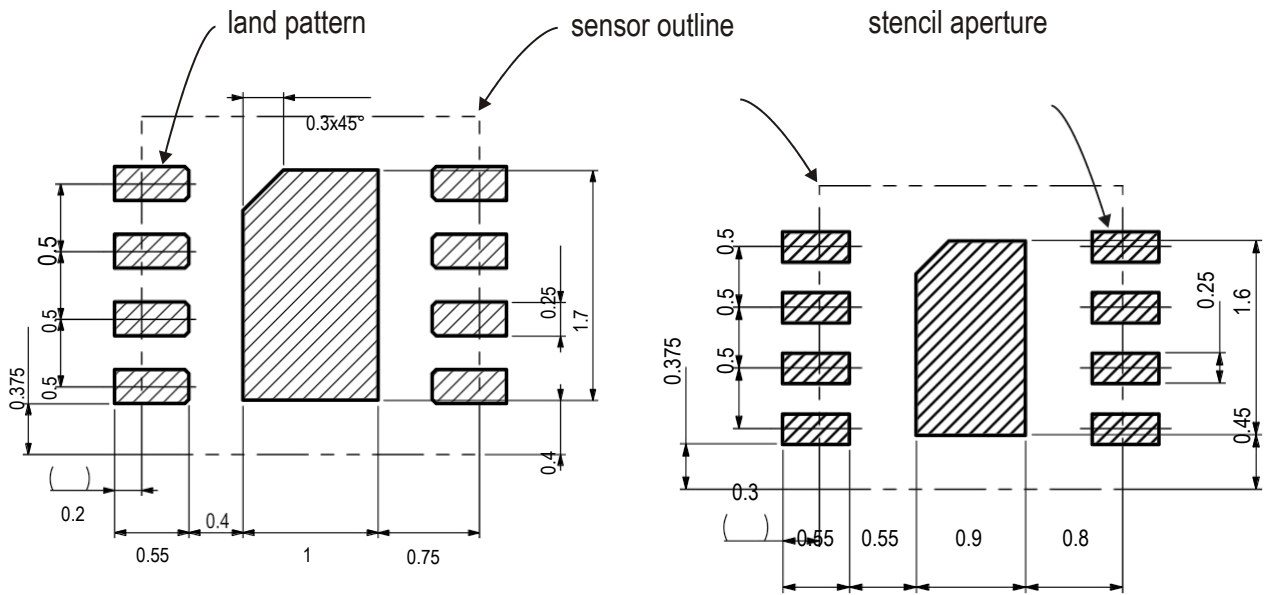

Figure 14 Dimensional drawing of GXHT3x-DIS sensor package

Parameter	Symbol	Min	Nom.	Max	Units	Comments
Package height	A	0.8	0.9	1	mm	
Leadframe height	A <sub>3</sub>	-	0.2	-	mm	
Pad width	b	0.2	0.25	0.3	mm	
Package width	D	2.4	2.5	2.6	mm	
Center pad length	D <sub>2</sub>	1	1.1	1.2	mm	
Package length	E	2.4	2.5	2.6	mm	
Center pad width	E <sub>2</sub>	1.7	1.8	1.9	mm	
Pad pitch	e	-	0.5		mm	
Pad length	L	0.3	0.35	0.4	mm	
Max cavity	S	-	-	1.5	mm	Only as guidance. This value includes all tolerances, including displacement tolerances. Typically the opening will be smaller.
Center pad marking	T1xT2	-	0.3x45°	-	mm	indicates the position of pin 1

Table 21 Package outline.





**Figure 15** Recommended metal land pattern (left) and stencil apertures (right) for the GXHT3x-DIS. The dashed lines represent the outer dimension of the DFN package. The PCB pads (left) and stencil apertures (right) are indicated through the shaded areas

