



HESTORE.HU

elektronikai alkatrész áruház

EN: This Datasheet is presented by the manufacturer.

Please visit our website for pricing and availability at www.hestore.hu.

IRFB4110PbF

HEXFET® Power MOSFET

Applications

- High Efficiency Synchronous Rectification in SMPS
- Uninterruptible Power Supply
- High Speed Power Switching
- Hard Switched and High Frequency Circuits

Benefits

- Improved Gate, Avalanche and Dynamic dv/dt Ruggedness
- Fully Characterized Capacitance and Avalanche SOA
- Enhanced body diode dV/dt and dI/dt Capability

V_{DSS}	100V
R_{DS(on)} typ.	3.7mΩ
	4.5mΩ
I_D (Silicon Limited)	180A ①
I_D (Package Limited)	120A

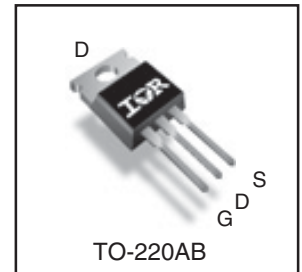
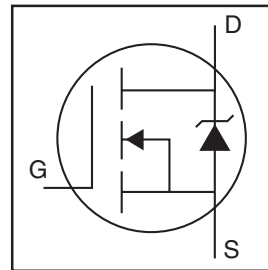

G	D	S
Gate	Drain	Source

Absolute Maximum Ratings

Symbol	Parameter	Max.	Units
I _D @ T _C = 25°C	Continuous Drain Current, V _{GS} @ 10V (Silicon Limited)	180①	A
I _D @ T _C = 100°C	Continuous Drain Current, V _{GS} @ 10V (Silicon Limited)	130①	
I _D @ T _C = 25°C	Continuous Drain Current, V _{GS} @ 10V (Wire Bond Limited)	120	
I _{DM}	Pulsed Drain Current ②	670	
P _D @ T _C = 25°C	Maximum Power Dissipation	370	W
	Linear Derating Factor	2.5	W/°C
V _{GS}	Gate-to-Source Voltage	± 20	V
dv/dt	Peak Diode Recovery ④	5.3	V/ns
T _J	Operating Junction and	-55 to + 175	°C
T _{STG}	Storage Temperature Range		
	Soldering Temperature, for 10 seconds (1.6mm from case)		
	Mounting torque, 6-32 or M3 screw	10lb·in (1.1N·m)	

Avalanche Characteristics

E _{AS} (Thermally limited)	Single Pulse Avalanche Energy ③	190	mJ
I _{AR}	Avalanche Current ②	See Fig. 14, 15, 22a, 22b	A
E _{AR}	Repetitive Avalanche Energy ⑤		mJ

Thermal Resistance

Symbol	Parameter	Typ.	Max.	Units
R _{θJC}	Junction-to-Case ③	—	0.402	°C/W
R _{θCS}	Case-to-Sink, Flat Greased Surface	0.50	—	
R _{θJA}	Junction-to-Ambient ③	—	62	

Static @ T_J = 25°C (unless otherwise specified)

Symbol	Parameter	Min.	Typ.	Max.	Units	Conditions
V _{(BR)DSS}	Drain-to-Source Breakdown Voltage	100	—	—	V	V _{GS} = 0V, I _D = 250μA
ΔV _{(BR)DSS/ΔT_J}	Breakdown Voltage Temp. Coefficient	—	0.108	—	V/°C	Reference to 25°C, I _D = 5mA ^②
R _{DS(on)}	Static Drain-to-Source On-Resistance	—	3.7	4.5	mΩ	V _{GS} = 10V, I _D = 75A ^⑤
V _{GS(th)}	Gate Threshold Voltage	2.0	—	4.0	V	V _{DS} = V _{GS} , I _D = 250μA
I _{bSS}	Drain-to-Source Leakage Current	—	—	20	μA	V _{DS} = 100V, V _{GS} = 0V
		—	—	250		V _{DS} = 100V, V _{GS} = 0V, T _J = 125°C
I _{GSS}	Gate-to-Source Forward Leakage	—	—	100	nA	V _{GS} = 20V
	Gate-to-Source Reverse Leakage	—	—	-100		V _{GS} = -20V

Dynamic @ T_J = 25°C (unless otherwise specified)

Symbol	Parameter	Min.	Typ.	Max.	Units	Conditions
g _{fs}	Forward Transconductance	160	—	—	S	V _{DS} = 50V, I _D = 75A
Q _g	Total Gate Charge	—	150	210	nC	I _D = 75A
Q _{gs}	Gate-to-Source Charge	—	35	—		V _{DS} = 50V
Q _{gd}	Gate-to-Drain ("Miller") Charge	—	43	—		V _{GS} = 10V ^⑤
R _G	Gate Resistance	—	1.3	—	Ω	
t _{d(on)}	Turn-On Delay Time	—	25	—	ns	V _{DD} = 65V
t _r	Rise Time	—	67	—		I _D = 75A
t _{d(off)}	Turn-Off Delay Time	—	78	—		R _G = 2.6Ω
t _f	Fall Time	—	88	—		V _{GS} = 10V ^⑤
C _{iss}	Input Capacitance	—	9620	—	pF	V _{GS} = 0V
C _{oss}	Output Capacitance	—	670	—		V _{DS} = 50V
C _{rss}	Reverse Transfer Capacitance	—	250	—		f = 1.0MHz
C _{oss eff. (ER)}	Effective Output Capacitance (Energy Related) ^④	—	820	—		V _{GS} = 0V, V _{DS} = 0V to 80V ^⑥
C _{oss eff. (TR)}	Effective Output Capacitance (Time Related) ^④	—	950	—		V _{GS} = 0V, V _{DS} = 0V to 80V ^⑥

Diode Characteristics

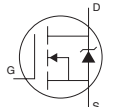
Symbol	Parameter	Min.	Typ.	Max.	Units	Conditions
I _S	Continuous Source Current (Body Diode)	—	—	170 ^①	A	MOSFET symbol showing the integral reverse p-n junction diode. 
I _{SM}	Pulsed Source Current (Body Diode) ^{②⑦}	—	—	670		
V _{SD}	Diode Forward Voltage	—	—	1.3	V	T _J = 25°C, I _S = 75A, V _{GS} = 0V ^⑤
t _{rr}	Reverse Recovery Time	—	50	75	ns	T _J = 25°C V _R = 85V, T _J = 125°C I _F = 75A
Q _{rr}	Reverse Recovery Charge	—	94	140	nC	T _J = 25°C di/dt = 100A/μs ^⑤ T _J = 125°C
I _{RRM}	Reverse Recovery Current	—	3.5	—	A	T _J = 25°C
t _{on}	Forward Turn-On Time	Intrinsic turn-on time is negligible (turn-on is dominated by LS+LD)				

Notes:

- ① Calculated continuous current based on maximum allowable junction temperature. Bond wire current limit is 120A. Note that current limitations arising from heating of the device leads may occur with some lead mounting arrangements.
- ② Repetitive rating; pulse width limited by max. junction temperature.
- ③ Limited by T_{Jmax}, starting T_J = 25°C, L = 0.033mH
R_G = 25Ω, I_{AS} = 108A, V_{GS} = 10V. Part not recommended for use above this value.
- ④ I_{SD} ≤ 75A, di/dt ≤ 630A/μs, V_{DD} ≤ V_{(BR)DSS}, T_J ≤ 175°C.
- ⑤ Pulse width ≤ 400μs; duty cycle ≤ 2%.
- ⑥ C_{oss eff. (TR)} is a fixed capacitance that gives the same charging time as C_{oss} while V_{DS} is rising from 0 to 80% V_{DSS}.
- ⑦ C_{oss eff. (ER)} is a fixed capacitance that gives the same energy as C_{oss} while V_{DS} is rising from 0 to 80% V_{DSS}.
- ⑧ When mounted on 1" square PCB (FR-4 or G-10 Material). For recommended footprint and soldering techniques refer to application note #AN-994.
- ⑨ R_{θj} is measured at T_J approximately 90°C.

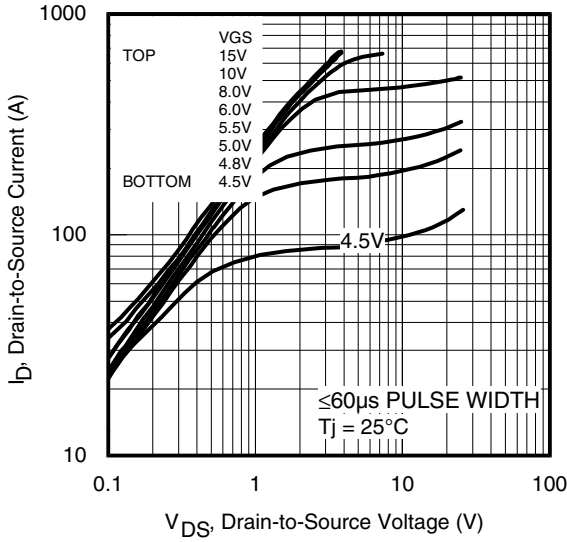

Fig 1. Typical Output Characteristics

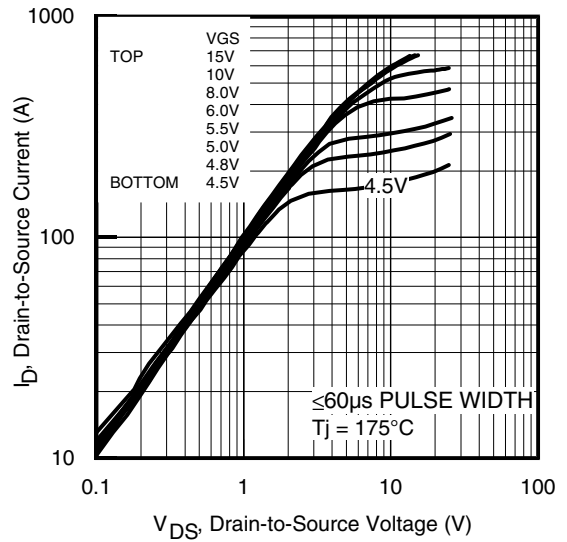

Fig 2. Typical Output Characteristics

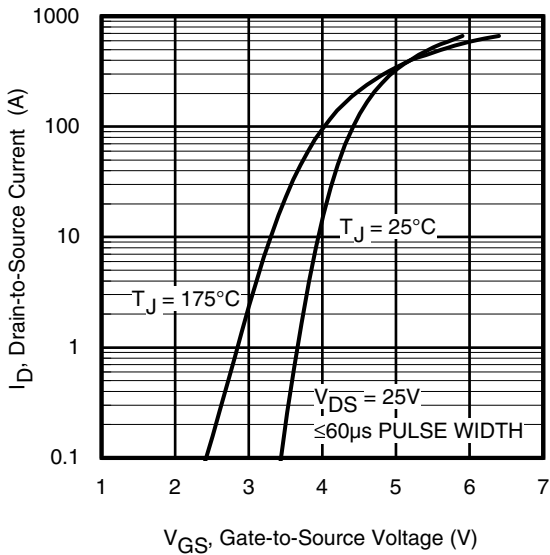

Fig 3. Typical Transfer Characteristics

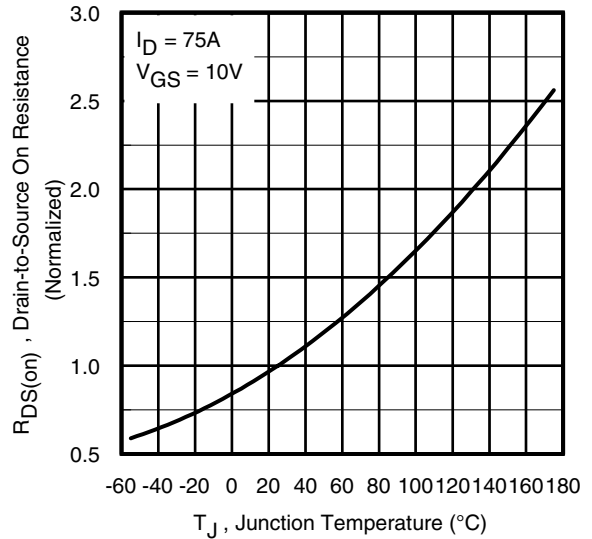

Fig 4. Normalized On-Resistance vs. Temperature

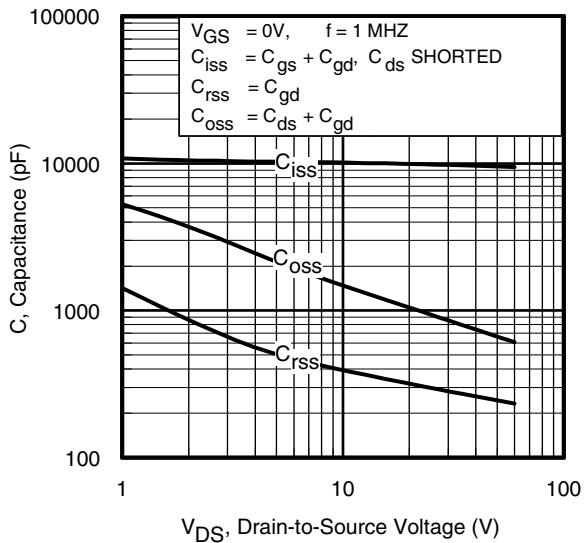

Fig 5. Typical Capacitance vs. Drain-to-Source Voltage

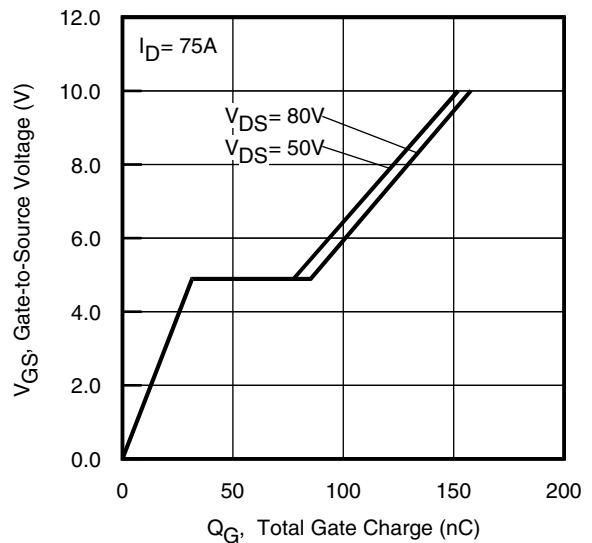

Fig 6. Typical Gate Charge vs. Gate-to-Source Voltage

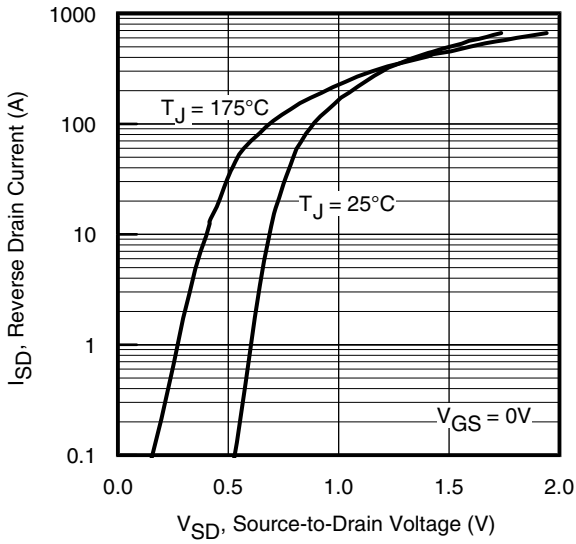

Fig 7. Typical Source-Drain Diode Forward Voltage

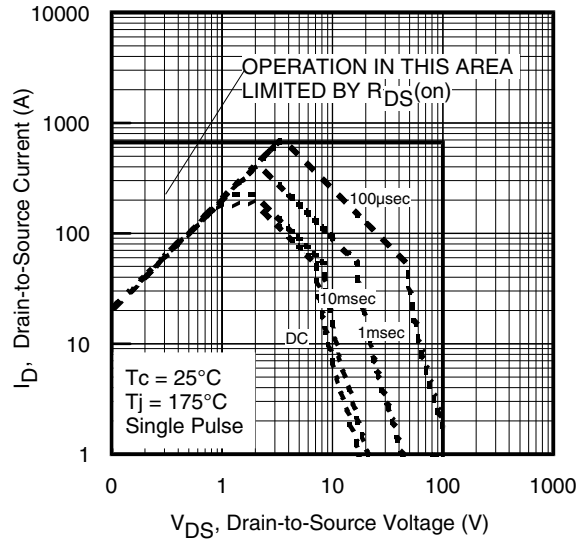

Fig 8. Maximum Safe Operating Area

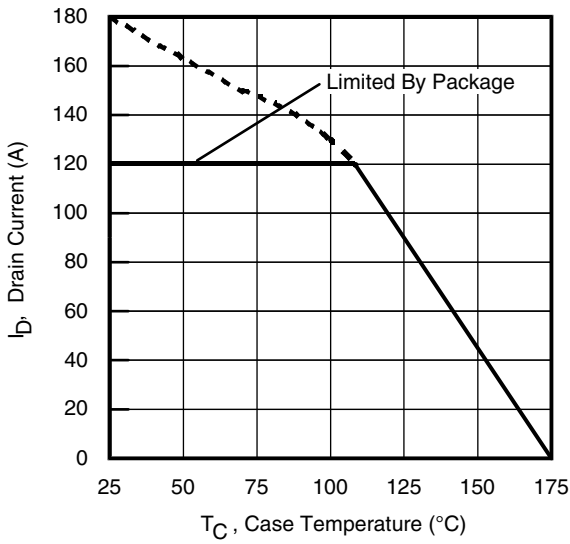

Fig 9. Maximum Drain Current vs. Case Temperature

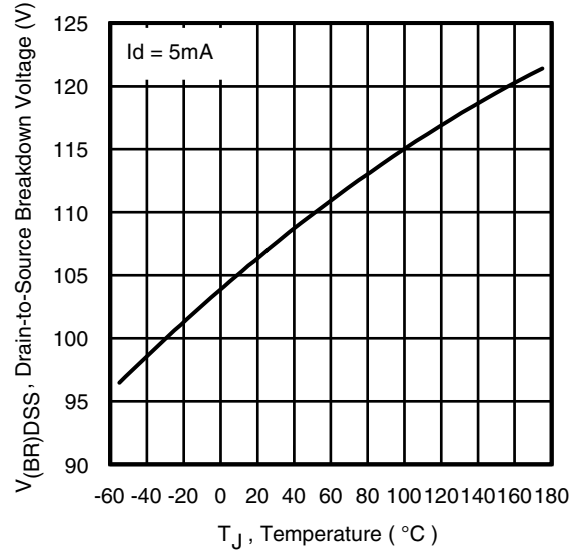

Fig 10. Drain-to-Source Breakdown Voltage

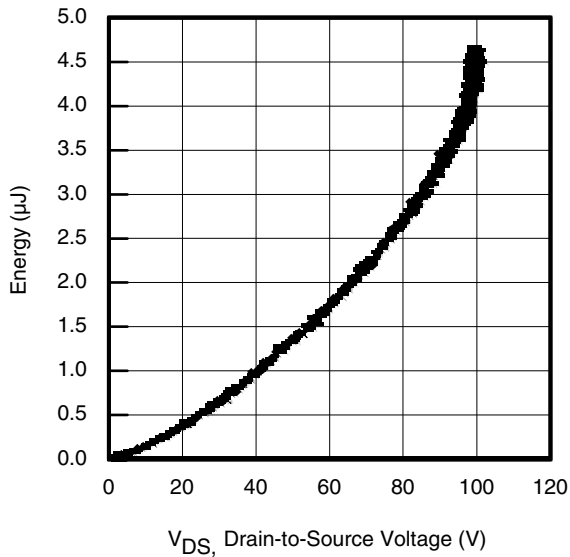

Fig 11. Typical C_{OSS} Stored Energy

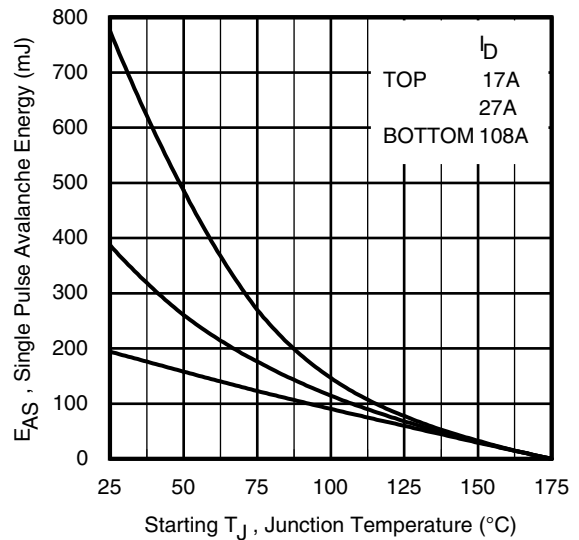

Fig 12. Maximum Avalanche Energy vs. Drain Current

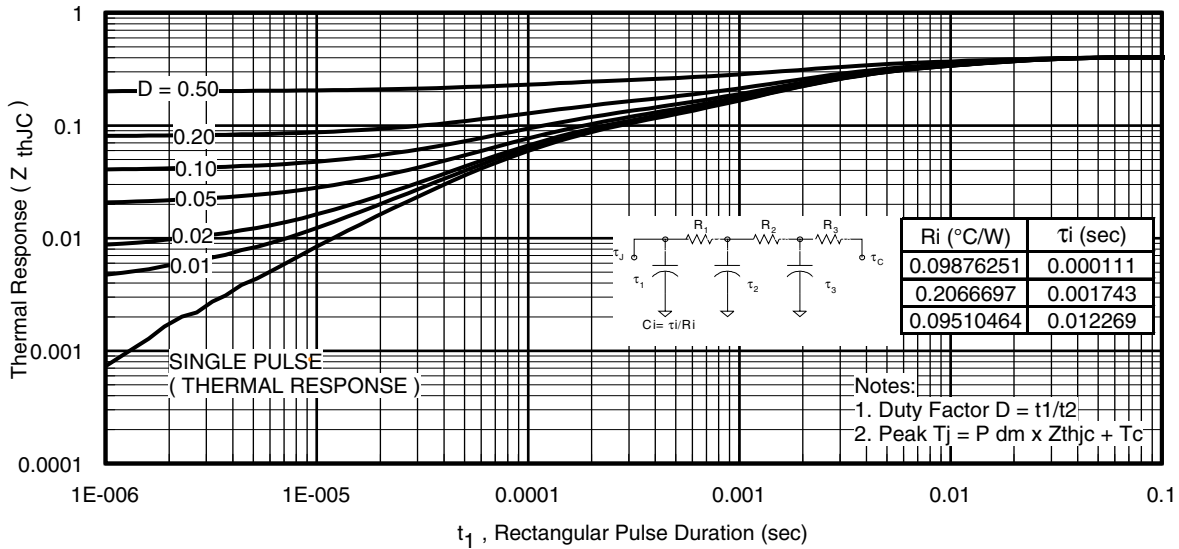

Fig 13. Maximum Effective Transient Thermal Impedance, Junction-to-Case

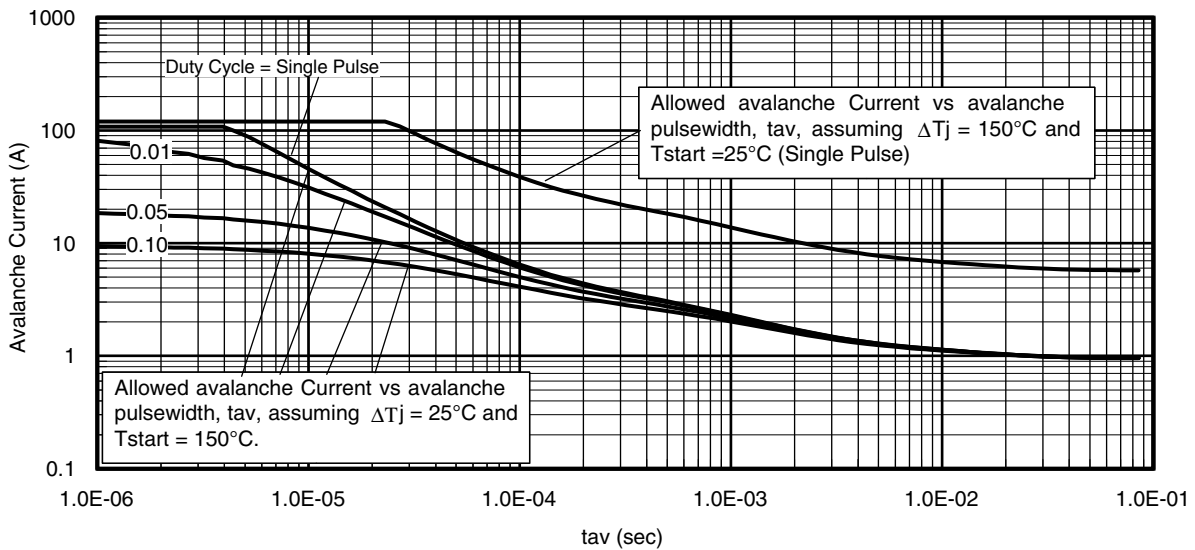
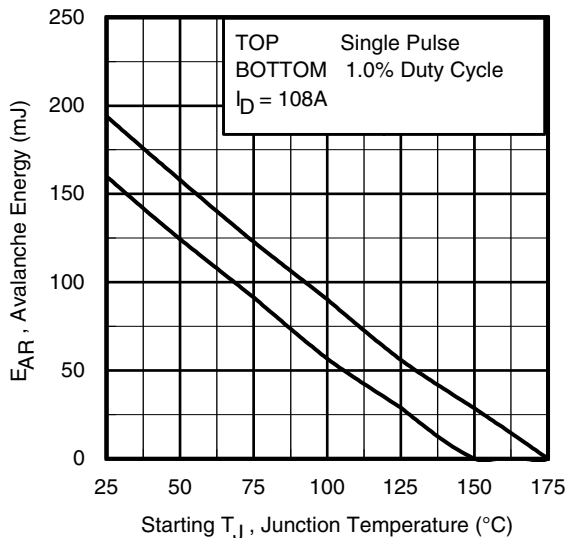

Fig 14. Typical Avalanche Current vs. Pulsewidth



Notes on Repetitive Avalanche Curves, Figures 14, 15:
(For further info, see AN-1005 at www.irf.com)

1. Avalanche failures assumption:
Purely a thermal phenomenon and failure occurs at a temperature far in excess of T_{jmax} . This is validated for every part type.
2. Safe operation in Avalanche is allowed as long as T_{jmax} is not exceeded.
3. Equation below based on circuit and waveforms shown in Figures 16a, 16b.
4. $P_{D(ave)}$ = Average power dissipation per single avalanche pulse.
5. BV = Rated breakdown voltage (1.3 factor accounts for voltage increase during avalanche).
6. I_{av} = Allowable avalanche current.
7. ΔT = Allowable rise in junction temperature, not to exceed T_{jmax} (assumed as 25°C in Figure 14, 15).
 t_{av} = Average time in avalanche.
 D = Duty cycle in avalanche = $t_{av} \cdot f$
 $Z_{thJC}(D, t_{av})$ = Transient thermal resistance, see Figures 13)

$$P_{D(ave)} = 1/2 (1.3 \cdot BV \cdot I_{av}) = \Delta T / Z_{thJC}$$

$$I_{av} = 2\Delta T / [1.3 \cdot BV \cdot Z_{th}]$$

$$E_{AS(AR)} = P_{D(ave)} \cdot t_{av}$$

Fig 15. Maximum Avalanche Energy vs. Temperature

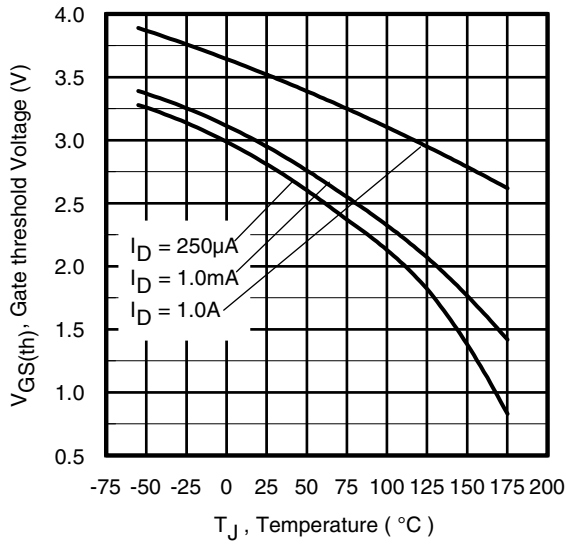

Fig 16. Threshold Voltage vs. Temperature

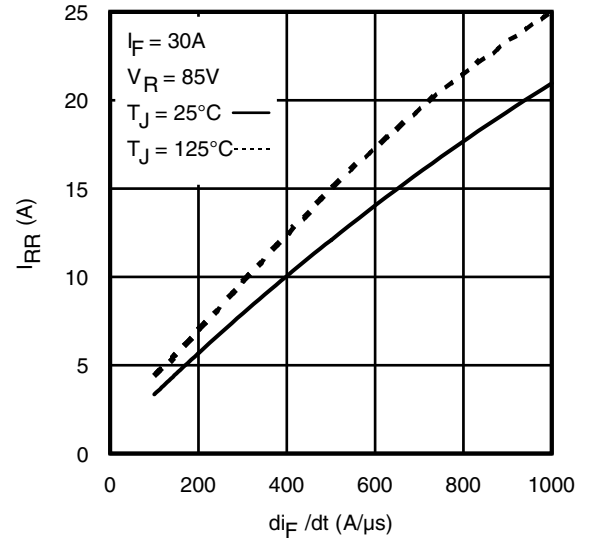

Fig. 17 - Typical Recovery Current vs. di_F/dt

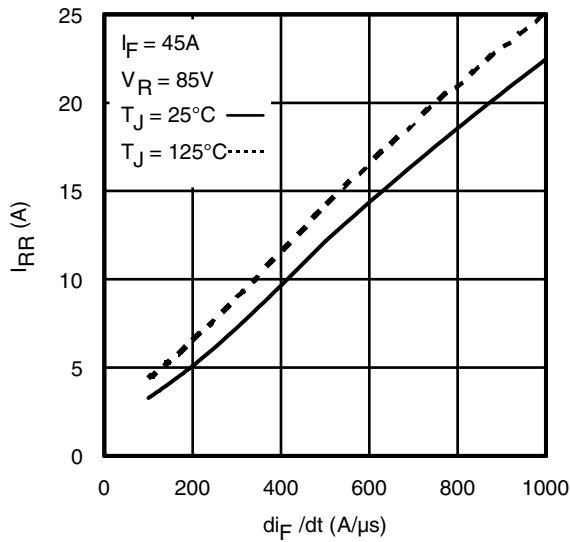

Fig. 18 - Typical Recovery Current vs. di_F/dt

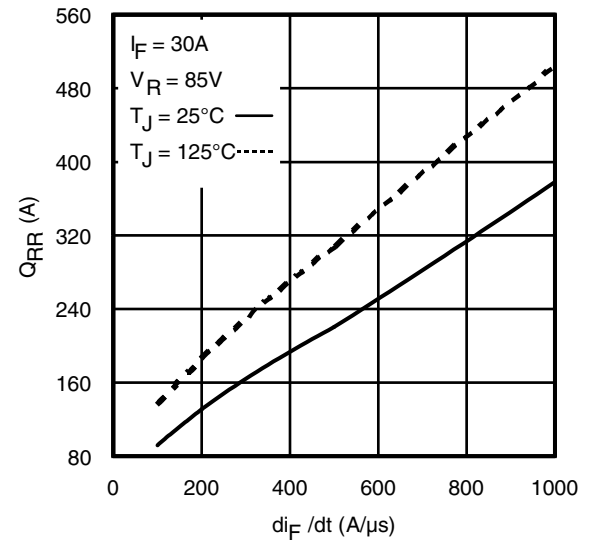

Fig. 19 - Typical Stored Charge vs. di_F/dt

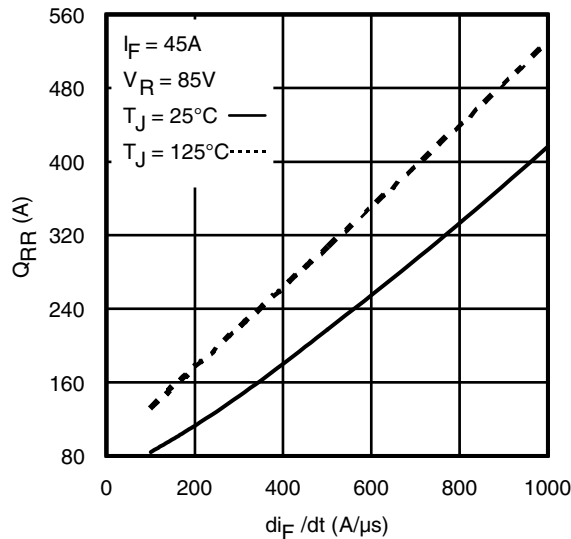
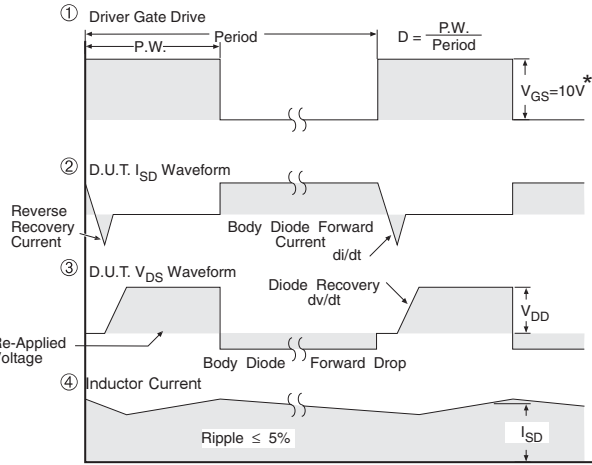
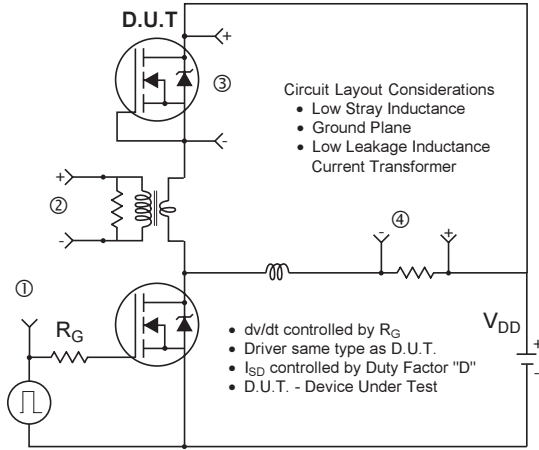

Fig. 20 - Typical Stored Charge vs. di_F/dt



* $V_{GS} = 5V$ for Logic Level Devices

Fig 20. Peak Diode Recovery dv/dt Test Circuit for N-Channel HEXFET[®] Power MOSFETs

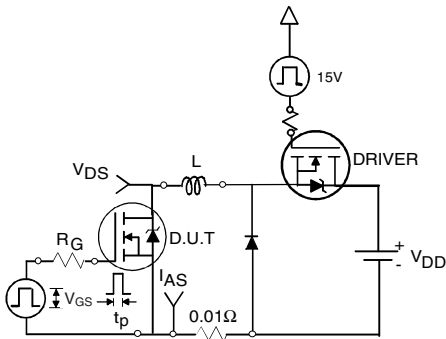

Fig 21a. Unclamped Inductive Test Circuit

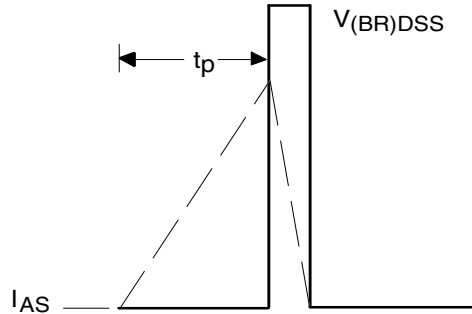

Fig 21b. Unclamped Inductive Waveforms

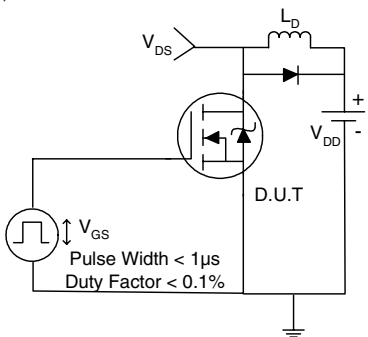

Fig 22a. Switching Time Test Circuit

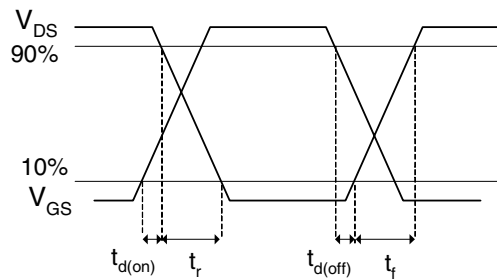

Fig 22b. Switching Time Waveforms

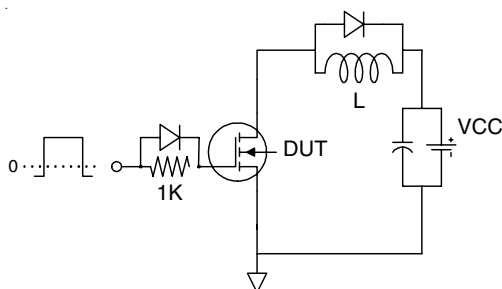

Fig 23a. Gate Charge Test Circuit

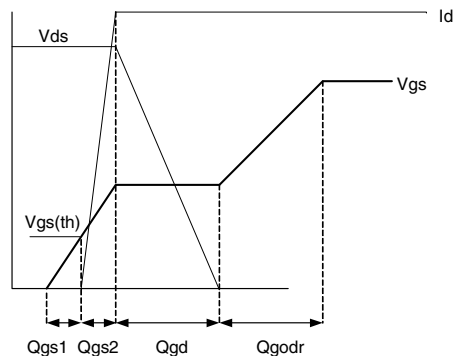
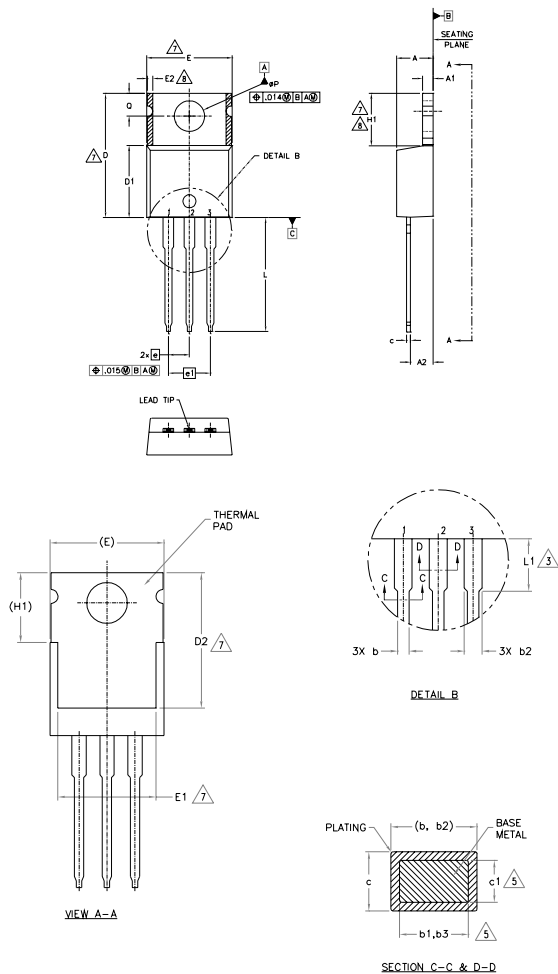

Fig 23b. Gate Charge Waveform

TO-220AB Package Outline (Dimensions are shown in millimeters (inches))



- NOTES:
- 1.- DIMENSIONING AND TOLERANCING AS PER ASME Y14.5 M- 1994.
 - 2.- DIMENSIONS ARE SHOWN IN INCHES [MILLIMETERS].
 - 3.- LEAD DIMENSION AND FINISH UNCONTROLLED IN L1.
 - 4.- DIMENSION D, D1 & E DO NOT INCLUDE MOLD FLASH. MOLD FLASH SHALL NOT EXCEED .005" (0.127) PER SIDE. THESE DIMENSIONS ARE MEASURED AT THE OUTERMOST EXTREMES OF THE PLASTIC BODY.
 - 5.- DIMENSION b1, b3 & c1 APPLY TO BASE METAL ONLY.
 - 6.- CONTROLLING DIMENSION : INCHES.
 - 7.- THERMAL PAD CONTOUR OPTIONAL WITHIN DIMENSIONS E,H1,D2 & E1
 - 8.- DIMENSION E2 X H1 DEFINE A ZONE WHERE STAMPING AND SINGULATION IRREGULARITIES ARE ALLOWED.
 - 9.- OUTLINE CONFORMS TO JEDEC TO-220, EXCEPT A2 (max.) AND D2 (min.) WHERE DIMENSIONS ARE DERIVED FROM THE ACTUAL PACKAGE OUTLINE.

SYMBOL	DIMENSIONS				NOTES
	MILLIMETERS		INCHES		
	MIN.	MAX.	MIN.	MAX.	
A	3.56	4.83	.140	.190	
A1	0.51	1.40	.020	.055	
A2	2.03	2.92	.080	.115	
b	0.38	1.01	.015	.040	
b1	0.38	0.97	.015	.038	5
b2	1.14	1.78	.045	.070	
b3	1.14	1.73	.045	.068	5
c	0.36	0.61	.014	.024	
c1	0.36	0.56	.014	.022	5
D	14.22	16.51	.560	.650	4
D1	8.38	9.02	.330	.355	
D2	11.68	12.88	.460	.507	7
E	9.65	10.67	.380	.420	4,7
E1	6.86	8.89	.270	.350	7
E2	-	0.76	-	.030	8
e	2.54 BSC		.100 BSC		
e1	5.08 BSC		.200 BSC		
H1	5.84	6.86	.230	.270	7,8
L	12.70	14.73	.500	.580	
L1	3.56	4.06	.140	.160	3
øP	3.54	4.08	.139	.161	
Q	2.54	3.42	.100	.135	

LEAD ASSIGNMENTS

- HEXFET
 1.- GATE
 2.- DRAIN
 3.- SOURCE

IGBTs, CoPACK

- 1.- GATE
 2.- COLLECTOR
 3.- EMITTER

DIODES

- 1.- ANODE
 2.- CATHODE
 3.- ANODE

TO-220AB Part Marking Information

EXAMPLE: THIS IS AN IRF1010
 LOT CODE 1789
 ASSEMBLED ON WW 19, 1997
 IN THE ASSEMBLY LINE 'C'
Note: "P" in assembly line position indicates "Lead-Free"

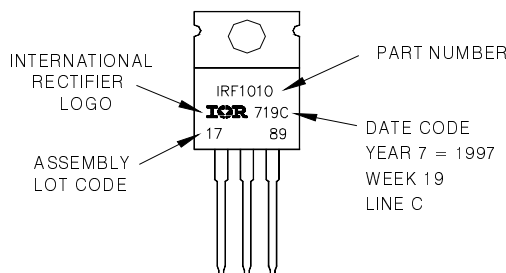

TO-220AB packages are not recommended for Surface Mount Application.

Note: For the most current drawing please refer to IR website at <http://www.irf.com/package/>

Data and specifications subject to change without notice.
 This product has been designed and qualified for the Industrial market.
 Qualification Standards can be found on IR's Web site.