



HESTORE.HU

elektronikai alkatrész áruház

EN: This Datasheet is presented by the manufacturer.

Please visit our website for pricing and availability at www.hestore.hu.



Ds212 Mini Oscilloscope

User Manual

Version 1.1

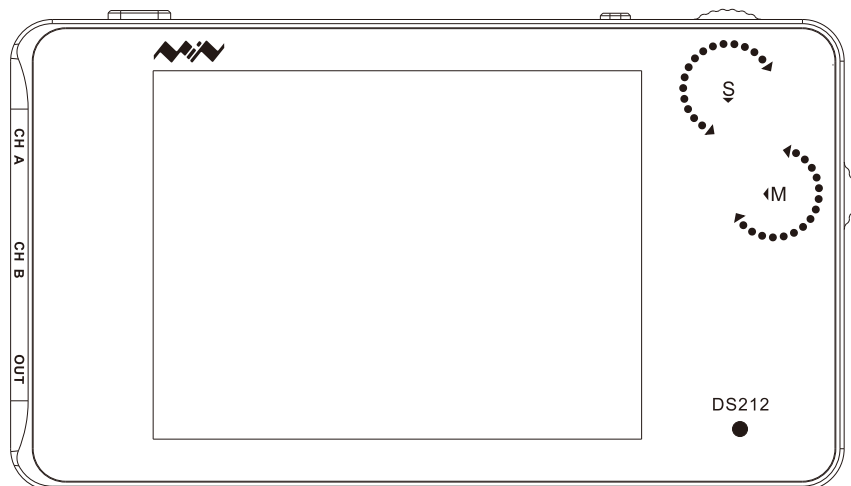

Contents

Important Safety Information	P1
Chapter 1 DS212 Overview	P2
Chapter 2 Interface Introduction	P5
Chapter 3 Getting Started	P8
Chapter 4 Functional Overview	P13
Chapter 5 Product Inspection	P20
Chapter 6 Battery Disposal	P21
Chapter 7 Technical Support	P22



Warning: Warning statements identify conditions or practices that could result in injury to yourself or others.



Caution: Caution statements identify conditions or practices that could result in damage to your device or other property.



Attention: Attention statements identify annotations, usage tips or additional information.

Important Safety Information

General Safety Information



- Read carefully all the following safety precautions to avoid personal injury and prevent damage to the device or any products connected to it. Failure to follow these safety instructions could result in personal injuries or risk of fire.



- **Use proper power supply.** Please use power supply specified for this product and certified for your country/district of use.
- **Connect and disconnect properly.** Do not connect or disconnect probe or test leads while they are connected to voltage source. Before you connect or disconnect current probes, please disconnect power to the circuit under test.
- **Observe all the terminal ratings.** To avoid fire or shock hazard, please do not measure signals at DC40V or above. Please read the User Manual carefully to learn more about ratings before connection.



- Do not operate in a humid environment.
- Do not operate in a potentially inflammable/explosive atmosphere.
- Please keep the device surface clean and dry.

Operating Environment

Operating Environment	Requirement	
Temperature	Operating Condition:	+0°C to 50°C
	Non-operating Condition:	-20°C to +60°C
Humidity	Operating Condition:	High Temperature: 40°C to 50°C, 0% to 90%RH
		Low Temperature : 0° C to 40°C, 10% to 90%RH
	Non-operating Condition:	High temperature: 40°C to 60°C, 5% to 95%RH
		Low temperature: 0° C to 40°C, 5% to 95%RH

DS212 Overview

Specifications

Performance parameters

Coupling	AC/DC
Analog bandwidth	1MHz
Maximum sampling rate	10MSa/s
Analog input impedance	1M Ω
Maximum input voltage	$\pm 40V$ (X1 probe)
Maximum sample memory depth	8K
Horizontal sensitivity	1 μ S/Div~2S/Div(in 1-2-5 sequence step)
Vertical sensitivity	20mv/Div~10V/Div (in 1-2-5 sequence step)



Functionalities

Modes	Vertical precise, horizontal precise measurement and trigger threshold
Trigger mode	Rising/Falling edge trigger
Synchronous mode	Auto, Normal, Single, None, Scan
Auto measurement	frequency, cycle time, duty cycle, DC RMS voltage/ Vpp /Vmax/Vmin/Vavg
Inbuilt signal Generator	10Hz~1MHz square wave (duty adjustable) or 10Hz~20KHz Sine/ Square/Triangle/Sawtooth wave

Product parameters

Storage	Inbuilt 8MB U disk storage for waveform data and images
Dimension	100mm×56.5mm×10mm
Battery	Internal 500mAh Lithium battery, external USB port
Display	Color TFT LCD display (320X240 pixels)

DS212 Overview

Interface & Buttons

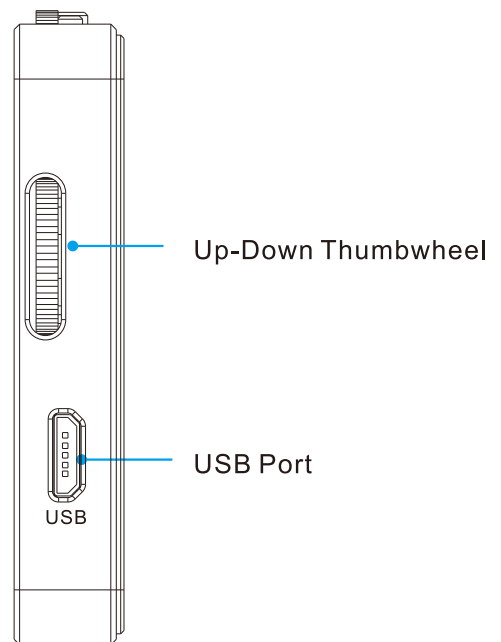
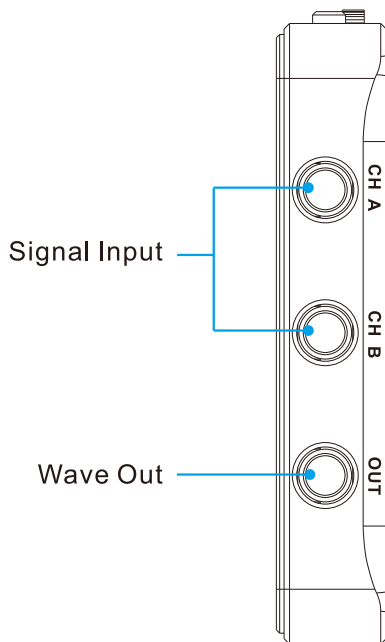
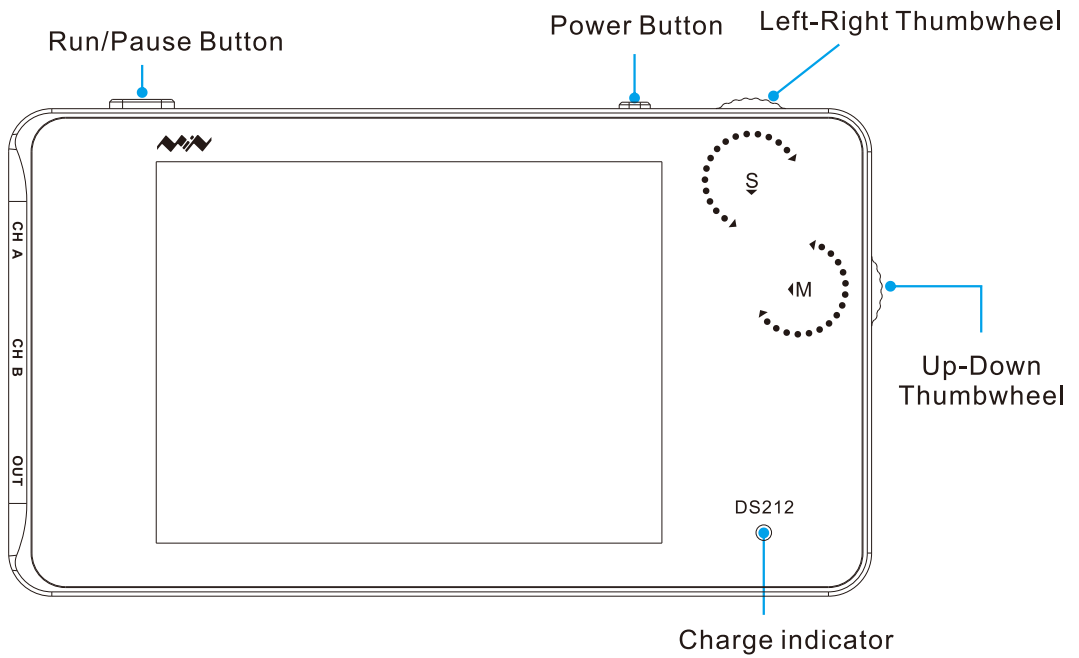

DS212 Overview

Operation on option area

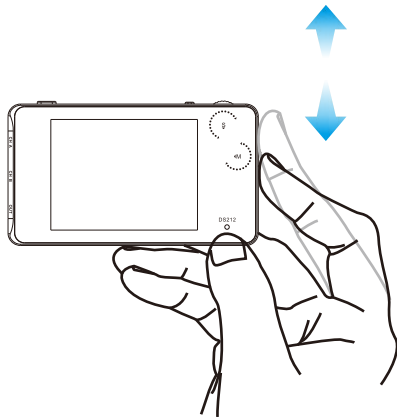

Dial Up/Down

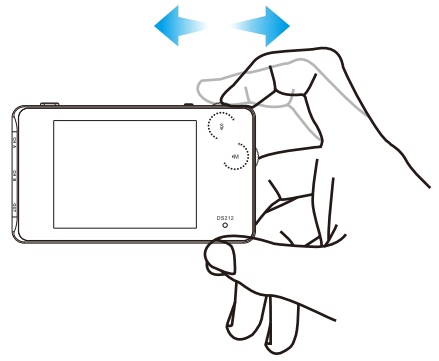

Dial Left/Right

Button	Function
	1)Click:Run/Pause 2)long press:Save current parameter/screen display
Wheel M	(Dial Up/Down) Choose up/down
Wheel M middle button	1)Click:Sub-menu On/Off 2)long press:Enter file management 3)Double click:When "Auto Fit" is ON, auto adjustment
Wheel S	Dial left/right to increase/decrease the setting parameters
Wheel S middle button	1)Click:Switch Menu/Confirm sub-menu 2)long press:Menu display/hide



Note that each item's color in Parameter Area is the same as that in Measurement Area.

Interface Introduction

Home screen introduction

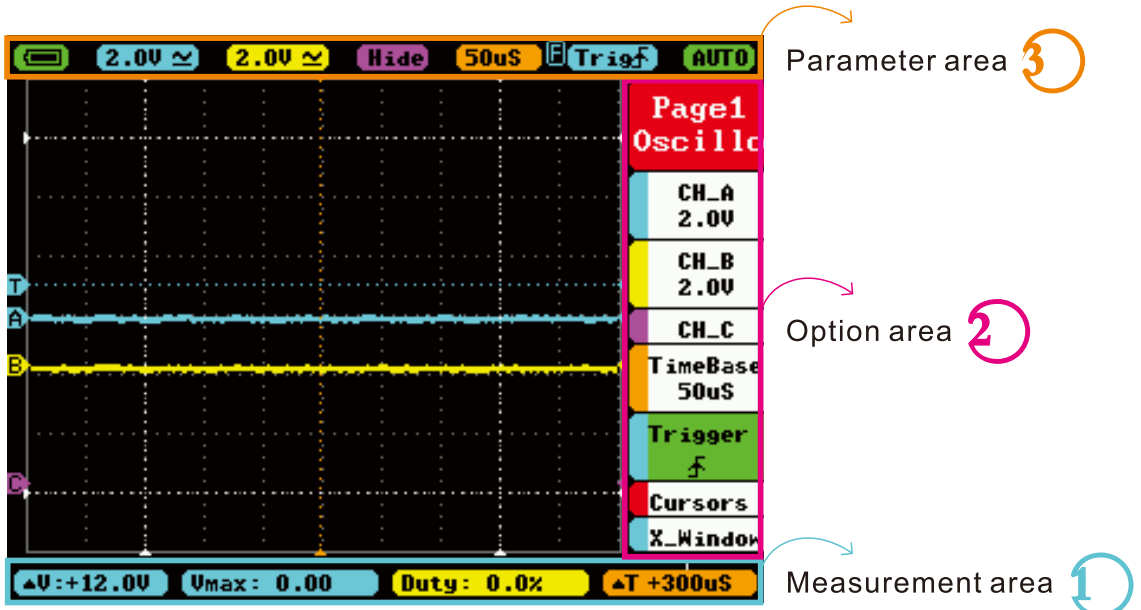

Home screen



Measurement area introduction



Menu	Function
ΔV: +6.00V	$\Delta V = V1 - V2$
Freq: 0.00Hz	Measured Value (Blue corresponds with Channel A, Yellow with Channel B) corresponding the 1st and 2nd item in Page2
Duty: 0.0%	
ΔT +120uS	$\Delta T = T2 - T1$

Interface Introduction

Home screen introduction



Option area introduction

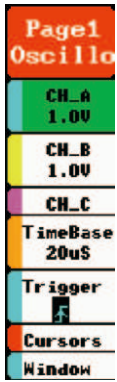
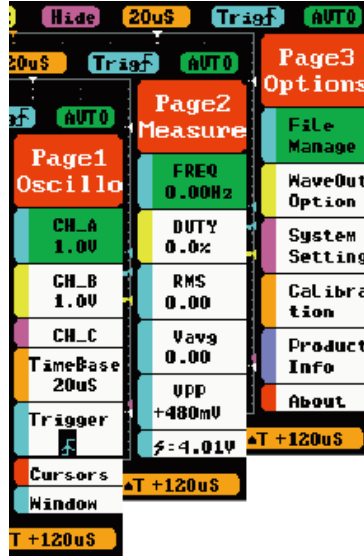

Page1(oscilloscope)

- Channel A option
- Channel B option
- Arithmetic Channel C option
- TimeBase option
- Trigger option
- Vernier option
- Horizontal window

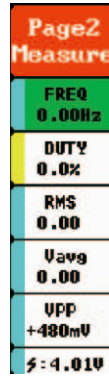

Page2(Measurement)

- Frequency
- Duty ratio
- Root-mean-square value
- Voltage average value
- Voltage peak-to-peak value
- Battery voltage



Page3(option)

- File management
- Output option
- System settings
- Calibration option
- Product information
- Relevant information



Annotation: detailed introduction to options refer to Page 13-19

Interface Introduction

Home screen introduction

3

Parameter area introduction



Menu	Item	Functions
	/ /	Battery supply/USB charging/Full charge
	20mV—10V(1-2-5 sequence step) AC/DC	(Channel A) y-axis voltage per grid, AC/ DC coupling method
	20mV—10V(1-2-5 sequence step) AC/DC	(Channel B) y-axis voltage per grid, AC/ DC coupling
	(-A)/(-B)/(A+B)/(A-B)/ RecA/RecB/RecC/Hide	(-A):Ch_A waveform reverses (-B): Ch_B waveform reverses (A+B): Ch_A waveform overlaps with Ch_B waveform; (A-B):Subtraction of channel A waveform and channel B waveform RecA:Reload the last waveform saved in Ch_A; RecB:Reload the last waveform saved in Ch_B RecC:Reload the last waveform saved in Ch_C Hide:Hide waveform
	1.0uS—1S(1-2-5sequence step)	Timebase (x-axis voltage per grid)
		Trigger mode: falling edge trigger/ rising edge trigger
	AUTO/NORM/SINGL/ NONE/SCAN/STOP	Auto/Normal/Single/Slow Scan/ Instant Scan/Run/Pause

Getting Started

Power On/Off

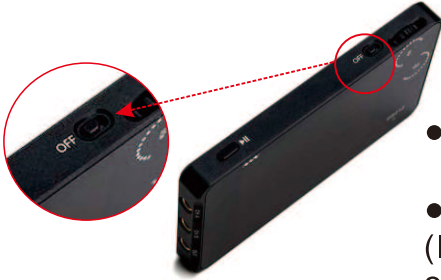

- "OFF" Power On/Off Button
- Switch power button to "OFF" to turn off DS212 (If DS212 was powered off automatically, switch off the power button before turning on.)

Turn on/off

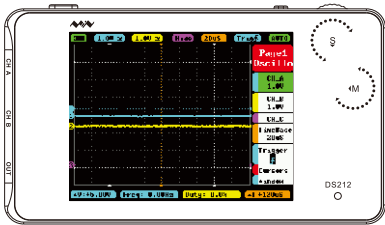

- Normally, turn on DS212, it enters APP1 by default.
- Hold Encoder S and turn on DS212, it enters APP2 (If APP2 is not installed, it enters DFU mode.)

Switch APP



- Hold Pause button "▶||" and turn on DS212, to enter DFU mode.

Upgrade mode

Getting Started

Check up before use

Make a quick inspection of functions to ensure the device is working soundly. Please perform following steps:

- Turn on power and access the homepage of the mini oscilloscope.
- Place in the standard signal (e.g. square wave 1 KHz, $V_{pp}=3V$), insert X1 probe's MCX end to CH A or CH B, and the probe to "OUT". Check if the measurement value and the standard value are equal, calibrate if different. See below for detailed instructions:

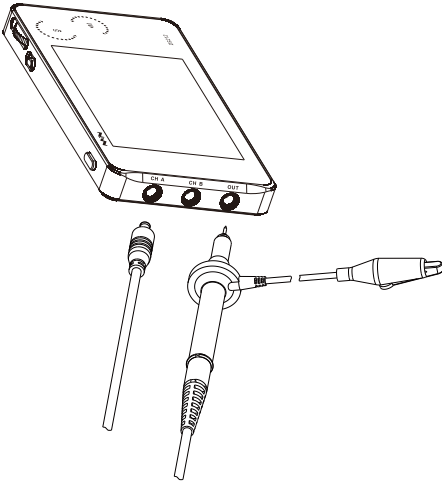

Connect probes to CH A and OUT

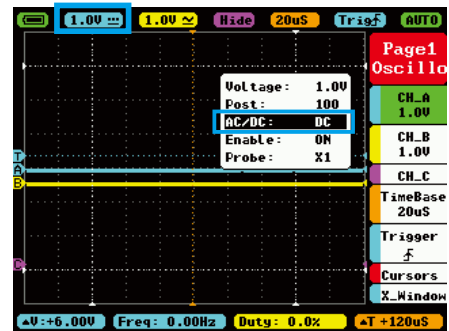

Adjust relevant parameters of CH A:

1. Adjust the DC mode in AC/DC function in CH A
2. Voltage adjustment: Switch Voltage to 1V

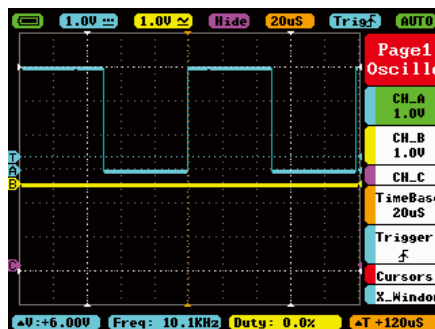

Measure WAVE OUT outlet waveform

Getting Started

Operation Introduction

Switch main menu

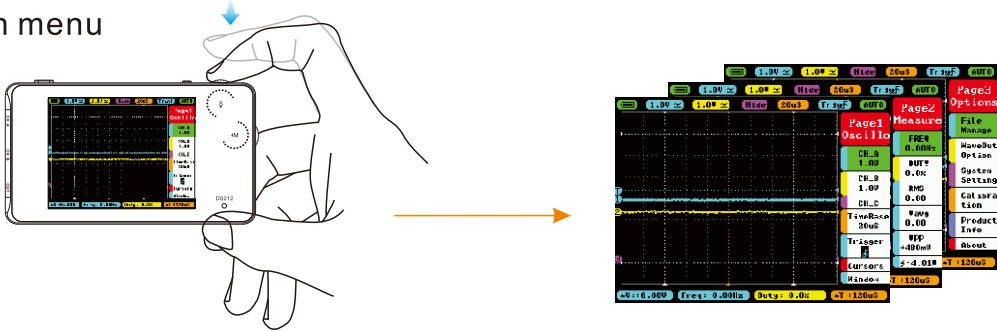

In main menu, middle click Encoder S to switch main menu.

Show/Hide main menu

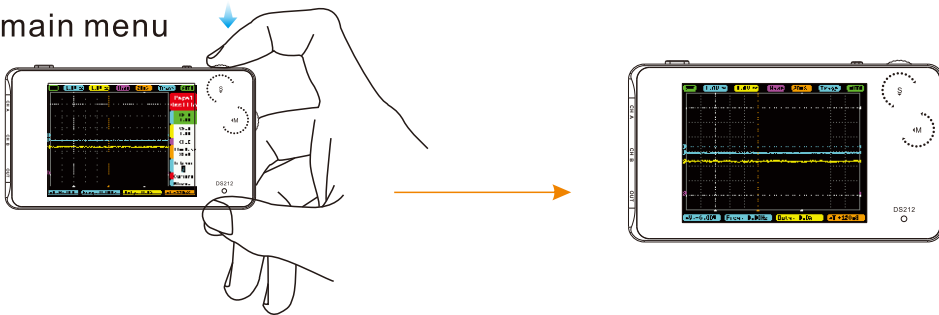

In main menu, hold Encoder S middle button to show/hide main menu.

Change time base

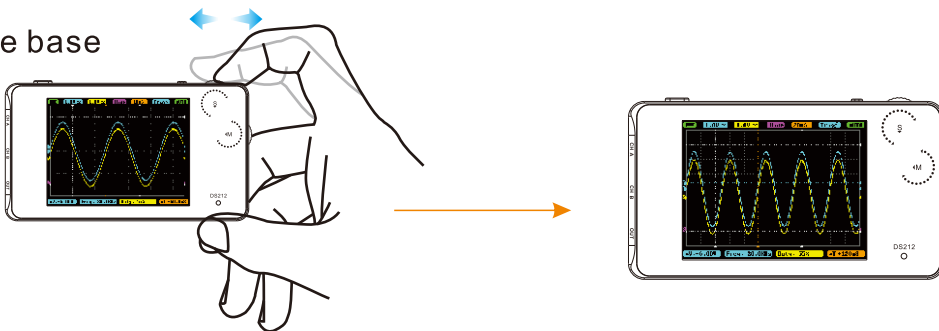

When hidden in main menu, dial left/right Encoder S to change time base (middle click Encoder S to switch current trigger channel).

Change voltage

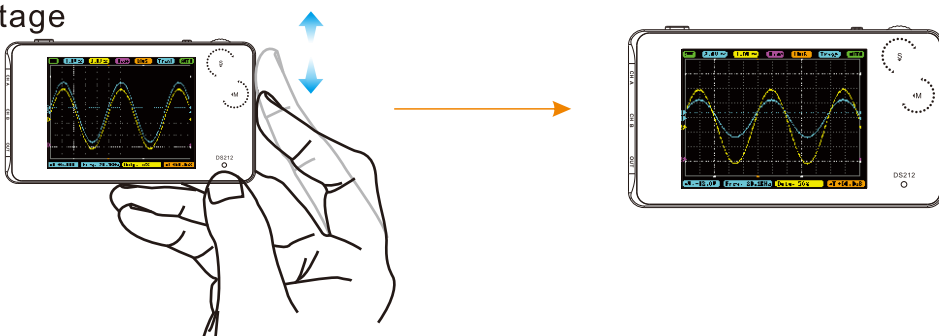

When hidden in main menu, dial up/down Encoder M to change voltage (middle click Encoder M to switch Channel A/B).

Getting Started

Operation Introduction

Show/Hide sub-menu

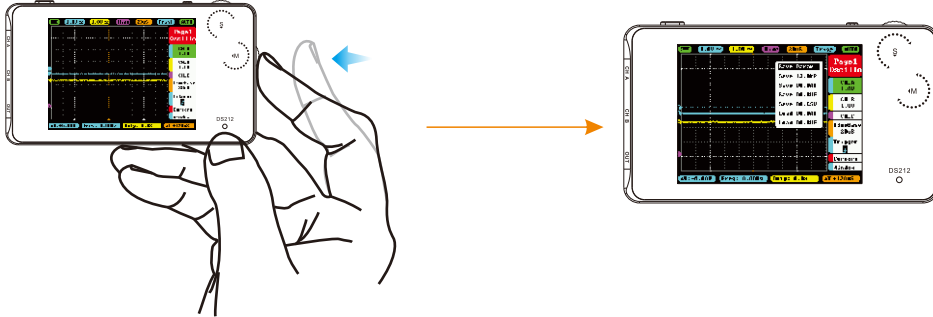

In main menu, middle click Encoder M to show/hide sub-menu.

Confirm option

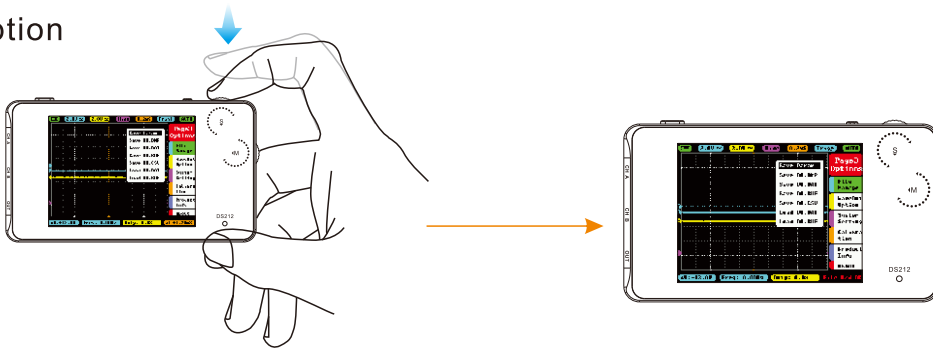

In sub-menu, middle click Encoder S to confirm operation.

Choose menu

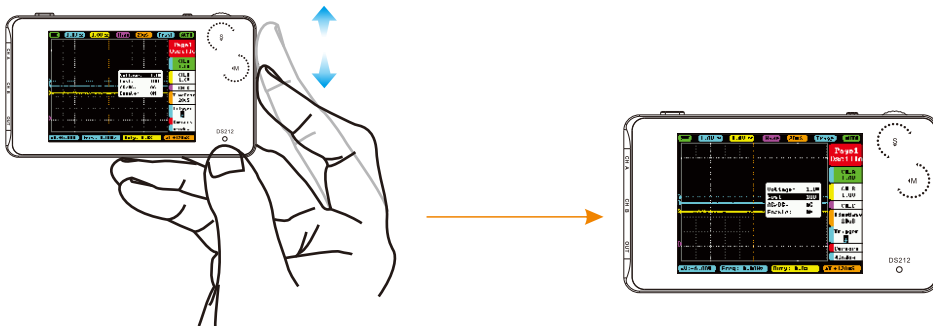

In main menu/sub-menu, dial up/down Encoder M to choose up/down menu options.

Getting Started

Operation Introduction

Adjust menu parameters

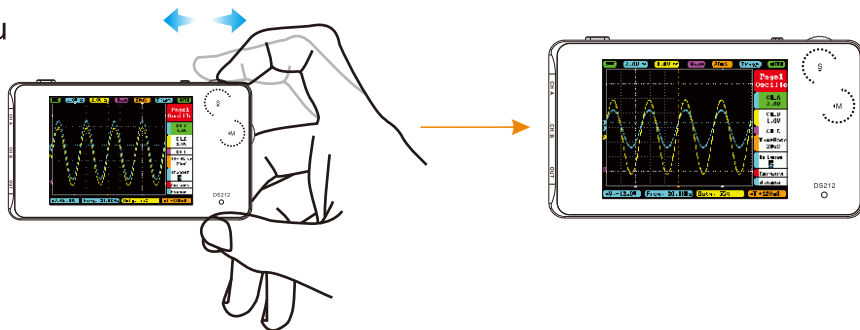

In main menu/sub-menu, dial left/right Encoder S to increase/decrease the setting parameters. (When adjusting parameters of "Post" in sub-menu, hold Encoder S middle button can fast adjust readings).

Show/Hide sub-menu of file management shortcut

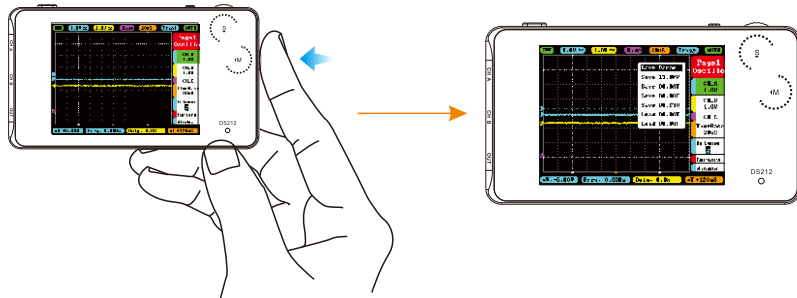

In main menu/sub-menu, hold Encoder M middle button to show/hide sub-menu of file management.

"Auto Fit" setting

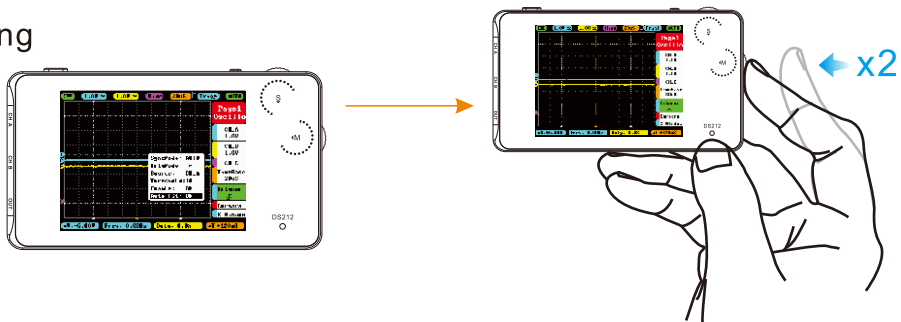

Enter "Trigger" in "Page 1" of main menu, set "Auto Fit" to "ON", double click Encoder M middle button, DS212 will automatically calibrate amplitude, time base and trigger.

Auto-off setting

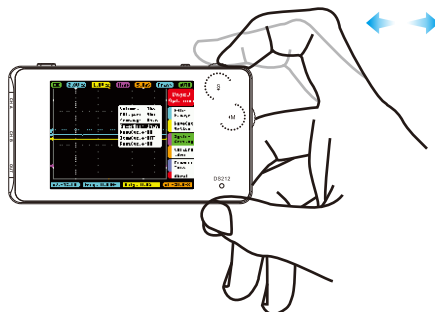

Enter "system setting" of "Page 3" under main menu, choose "Power off", and dial Encoder S left/right to choose the time setting of auto power off. If charging via USB, auto power off will not be activated.

Functional Overview

Overview of Menu options

DS212 Menu

Page1 Oscillo

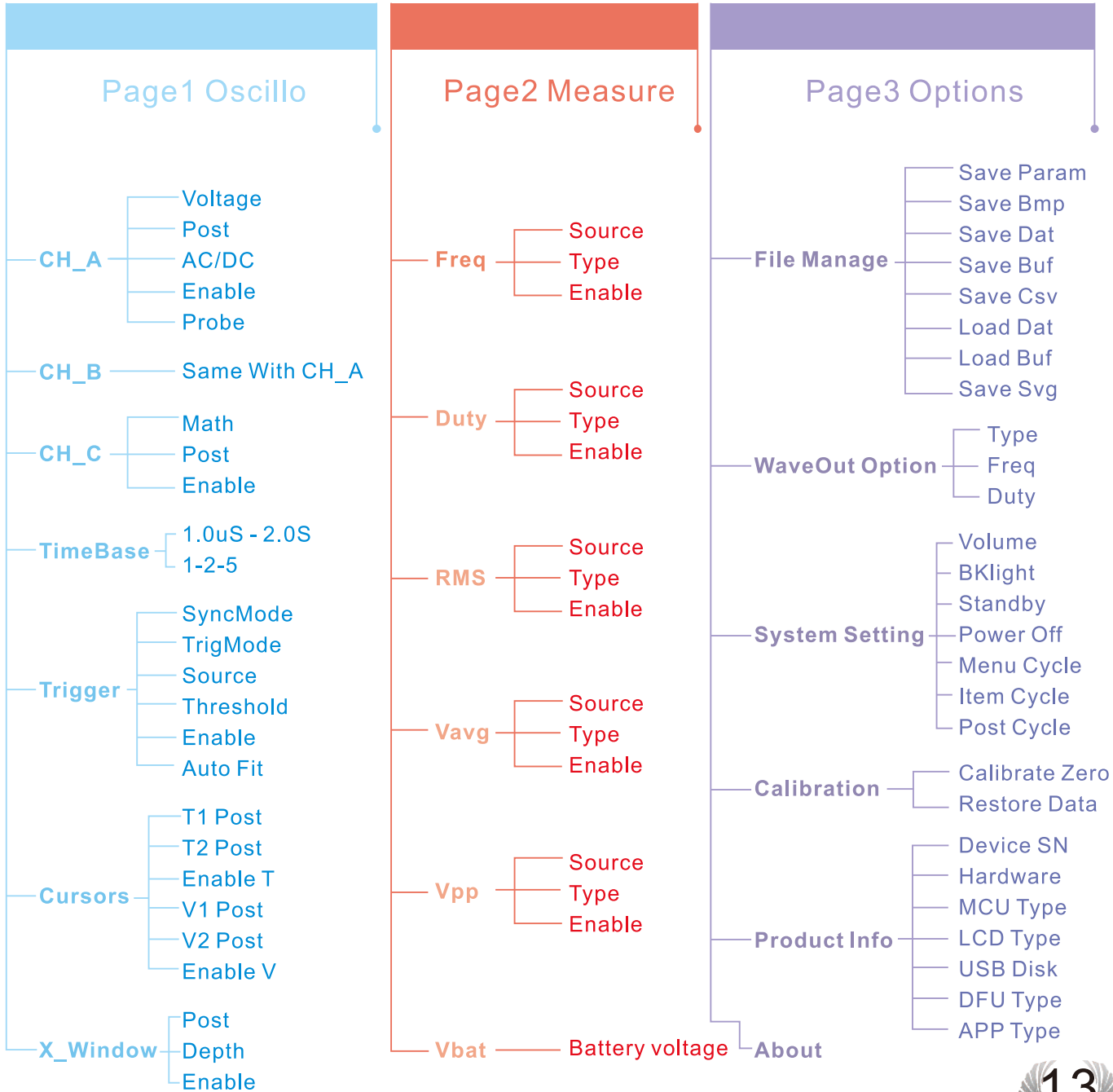

Page2 Measure

Page3 Options



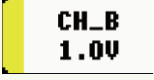

Functional Overview

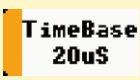
Specific Parameter Intro

Menu	Options	Functions	Annotation for Functions	Description
Page1 Oscillo Page1 Oscillo		Voltage	Channel A y-axis voltage per grid	20mV/50mV/0.1V/0.2V/0.5V/1.0V/2.0V/5.0V/10V
		Post	Adjust Channel A waveform position upward/downward in the window	Position:5-195
		AC/DC	Channel A coupling	AD/DC
		Enable	Channel A display/hide	ON/OFF
		Probe		X1 / X10
		Voltage	Channel B y-axis voltage per grid	20mV/50mV/0.1V/0.2V/0.5V/1.0V/2.0V/5.0V/10V
		Post	Adjust Channel B waveform position upward/downward in the window	Position : 5-195
		AC/DC	Channel B coupling	AD/DC
		Enable	Channel B display/hide	ON/OFF
		Probe		X1 / X10
		Match	Calculation between CH_A waveform and CH_B waveform	-A, -B,A+B,A-B, RecA,RecB,RecC
		Post	Adjust CH_C waveform position upward/downward in the window	Position:5-195
		Enable	CH_C display / hide	ON/OFF
		TimeBase	TimeBase X-axis voltage per grid	1.0us-2.0s(1-2-5 sequence step)

Functional Overview

Specific Parameter Intro

Menu	Options	Functions	Annotation for Functions	Description
Page1 Oscillo Page1 Oscillo		Syncmode	Synchronous mode selection	AUTO/NORM/SINGL/ NONE/SCAN Note: Automatic/standard/ single/slow scan/ instant scan
		Trigmode	Trigger mode	Rising edge/Falling edge Trigger mode
		Source	Trigger channel	CH A/CH B
		Threshold	Horizontal trigger position level	Position:-80-110
		Enable	Display/Hide horizontal trigger position level	ON/OFF
		Auto Fit	Automatic adjustment	ON/OFF
		T1.Post	Time measurement cursor T1	Position : 5-248
		T2.Post	Time measurement cursor T2	Position:5-248
		Enable.T	Display/Hide time measurement cursor	ON/OFF
		V1.Post	Voltage Measurement Cursor V1	Site selection : 2-198
		V2.Post	Voltage measurement cursor V2	Site selection:2-198
		Enable.V	Display/Hide voltage measurement cursor	CH A/CH B/OFF



Functional Overview

Specific Parameter Intro

Menu	Item	Options	Annotation for Functions	Description
Page1 Oscillo	Window	Post	Horizontal movement to view waveform	Depends on sample memory depth
		Depth	Internal storage depth	1k/2k/4k/8k
		Enable	Display/hide trigger line cursor	ON/OFF
Page2 Measure	FREQ 0.00Hz	Source	Measurement channel	CH A/CH B
		Type	Measurement type	FREQ/DUTY/ RMS/ Vavg/Vpp/Max/Min Note: Frequency/Duty/ Root Mean Square/ Voltage Average/ Voltage Peak-Peak/ Voltage Maximum/ Voltage Minimum
		Enable	Display/Hide measurement window	ON/OFF
	DUTY 0.0%	Source	Measurement channel	CH A/CH B
		Type	Measurement type	FREQ/DUTY/RMS/ Vavg/Vpp/Vmax/ Vmin Note: Frequency/Duty/ Root Mean Square/ Voltage Average/ Voltage Peak-Peak/ Voltage Maximum/ Voltage Minimum
		Enable	Display/Hide measurement window	ON/OFF

Functional Overview

Specific Parameter Intro

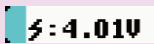
Menu	Options	Functions	Annotation for Functions	Description
Page2 Measure Page2 Measure		Source	Measurement channel	CH A/CH B
		Type	Measurement Type	FREQ/DUTY/RMS/ Vavg/Vpp/Max/Min
				Note: Frequency/Duty/ Root Mean Square/ Voltage Avergage/ Voltage Peak-Peak/ Voltage Maximum/ Voltage Minimum
	Enable	Display/Hide measurement window	ON/OFF	
		Source	Measurement channel	CH A/CH B
		Type	Measurement Type	FREQ/DUTY/RMS/ Vavg/Vpp/Max/Min
				Note: Frequency/Duty/ Root Mean Square/ Voltage Avergage/ Voltage Peak-Peak/ Voltage Maximum/ Voltage Minimum
	Enable	Display/Hide measurement window	ON/OFF	
		Source	Measurement Type	CH A/CH B
		Type	Measurement Type	FREQ/DUTY/RMS/ Vavg/Vpp/Max/Min
				Note: Frequency/Duty/ Root Mean Square/ Voltage Avergage/ Voltage Peak-Peak/ Voltage Maximum/ Voltage Minimum
	Enable	Display/Hide measurement window	ON/OFF	
	Vbat	Battery voltage		

Functional Overview

Specific Parameter Intro

Menu	Options	Functions	Annotation for Functions	Description	
Page3 Setting	File Manage	Save Param	Save current parameter settings	Middle click Encoder S to save	
		Save Bmp	Save bmp file (waveform image) to built-in U disk.	Middle click Encoder S to save. (Shortcut: long press "Run/Pause" button)	
		Save Dat	Save dat file to built-in U disk	Middle click Encoder S to save	
		Save Buf	Save buf file (sampling data in buffering area) to built-in U disk	Middle click Encoder S to save	
		Save Csv	Save csv file (export sampling data in buffering area) to built-in U disk	Middle click Encoder S to save	
		Load Dat	Load dat file	Middle click Encoder S to save	
		Load Buf	Load buf file	Middle click Encoder S to save	
		Save Svg	Save Svg file (sampling buffer figure) to built-in U disk	Middle click Encoder S to save	
	Page3 Options	WaveOut Option	Type	Output signal type	square/sine/triangle/sawtooth
			Freq	Output signal frequency	Square(10Hz-1Mhz)sine/triangle/sawtooth(10Hz-20kHz)
Duty			Output signal duty cycle	10%-90%	
System Setting		Volume	Adjust buzzer volume	0%-90%	
		Blight	Adjust backlight brightness	10%-100%	
		Standby	Adjust standby time	0min-60min	

Functional Overview

Dial up/down Encoder M to choose options in option menu, middle click Encoder M to open option setting menu; dial left/right Encoder S to choose parameters and change current values.

Specific Parameter Intro

Menu	Options	Functions	Annotation for Functions	Description	
Page3 Setting Page3 Options	System Setting	PowerOff	Auto power off time	0min-60min	
		MenuCycle	Main Menu option cycle	ON/OFF	
		ItemCycle	Sub-menu option cycle	ON/OFF	
		PostSlide	Ripid Slide post	ON/OFF	
	Calibra tion	Calibrate Zero	Middle click Encoder S, an auto calibration window will pop up, middle click Encoder S to auto calibrate; after auto calibration, save calibration data in the pop-up window.		
		Restore Data	Middle click Encoder S, a restore factory setting window will pop up, then middle click Encoder S to restore factory settings.		
	Product Info	DeviceSN	Device serial number		
		Hardware	Hardware version number		
		MCU Type	Processor type		
		LCD Type	LCD screen mode		
		USB Disk	U Disk capacity		
		DFU Type	DFU version		
		APP Type	APP version		
	About	Other relevant information			

Product Inspection

Charge and monitor the battery



- When the battery voltage status turns to “” or display brightness is relatively dim, please charge the battery in time. Charging is accessible in both power-on and off mode. When the battery is being charged, the LED will light on red until the charging process is finished.
- Under any circumstances, switching power button to OFF can turn off DS212.

General Inspection

- When you get a new mini DS212 Mini Oscilloscope, you are advised to inspect the product by the following steps.
- Inspect damages caused by shipping.
If the packaging carton is seriously damaged, keep the package until the oscilloscope & accessories pass the electrical and the mechanical test.
- Inspect the product.
Please contact the seller if the following problems occur:
 - 1) product surface is damaged,
 - 2) product doesn't work properly,
 - 3) product does not pass performance test.If the damage is resulted from shipping, please keep the package and contact the seller for repair or exchange.

Battery Disposal

Regulatory Markings



FCC compliance statement

This device is complied with the regulation in the 15th part of FCC regulation. Operation is subject to the following two conditions:
(1) This device may not cause harmful interference, and
(2) This device must accept any interference received, including the interference that may cause undesired operation.



The CE mark is a registered trademark of European Community. This CE mark shows that the product complies with all the relevant European Legal Directives.



This product contains batteries and/or recyclable electronic parts. Please do not dispose of the product together with household garbage. Please handle it according to your local laws and regulations.

Firmware upgrading

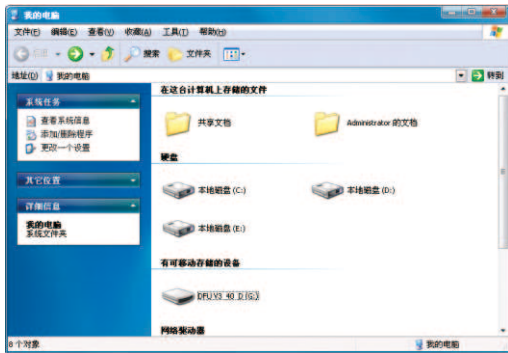

To upgrade the firmware of oscilloscope, please carry out the operation below:

1. Visit www.miniware.com.cn, download the applicable firmware appropriate to oscilloscope to your PC.
2. Hold “▶||” button and turn on DS212, to enter DFU mode for upgrade.
3. Use USB data cord to connect DS212 to your PC, and a removable hard disk named “DFU X.XX” will appear on your PC. Copy the hex firmware to the root directory of that disk. After the extension of the firmware changes from “hex” to “rdy”, restart DS212. Then the upgrading process is finished.

For more information, please visit www.miniware.com.cn.