



HESTORE.HU

elektronikai alkatrész áruház

EN: This Datasheet is presented by the manufacturer.

Please visit our website for pricing and availability at www.hestore.hu.



Designers' Choice

PLASTIC BATTERY HOLDERS

PLASTIC BATTERY HOLDERS FOR "AA" • "AAA" SIZES

- Economical design, available with PC terminals or wire leads
- Batteries securely held in place to assure a positive connection and maintain a low contact resistance
- Contact springs self-adjust to variations in battery length
- Withstands shock and vibration
- Available with solder lugs or male/female snap fasteners

SPECIFICATIONS

- **Holder:** Polypropylene
- **Springs:** Spring Steel, Nickel Plate
- **PC Pins:** .031 Brass, Nickel Plate
- **Wires (Red & Black):** #26AWG, Tinned, .187 end strip UL/CSA1007

Holds One (1) "AA" Cell

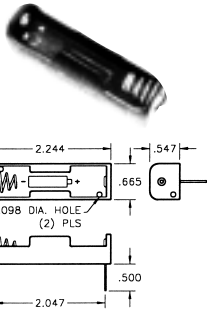

CAT. NO. 2460 – PC Mount
CAT. NO. 2461 – 6" Wire Leads

Holds Two (2) "AA" Cells in Series

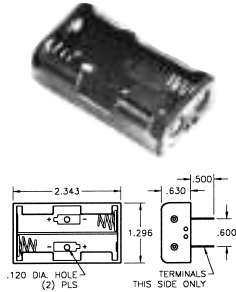

CAT. NO. 2462 – PC Mount
CAT. NO. 2463 – 6" Wire Leads

Holds Three (3) "AA" Cells in Series

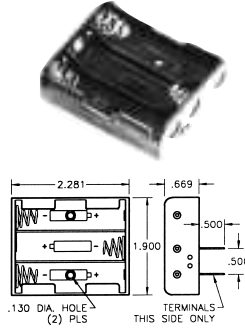

CAT. NO. 2464 – PC Mount
CAT. NO. 2465 – 6" Wire Leads

Holds Four (4) "AA" Cells in Series

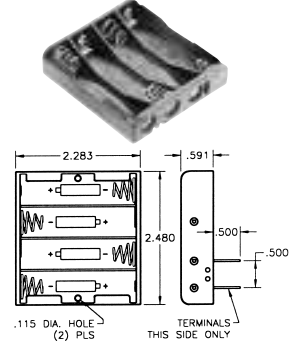

CAT. NO. 2477 – PC Mount
CAT. NO. 2478 – 6" Wire Leads

Holds One (1) "AAA" Cells

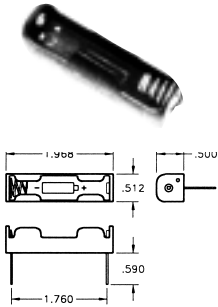

CAT. NO. 2466 – PC Mount
CAT. NO. 2467 – 6" Wire Leads

Holds Two (2) "AAA" Cells in Series

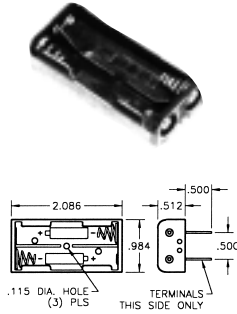

CAT. NO. 2468 – PC Mount
CAT. NO. 2469 – 6" Wire Leads

Holds Three (3) "AAA" Cells in Series

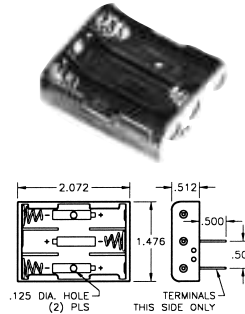

CAT. NO. 2479 – PC Mount
CAT. NO. 2480 – 6" Wire Leads

Holds Four (4) "AAA" Cells in Series

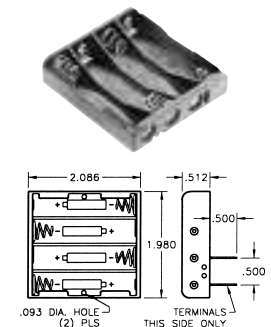

CAT. NO. 2481 – PC Mount
CAT. NO. 2482 – 6" Wire Leads

"AA" SIZE BATTERY HOLDERS WITH SNAP-ON CONNECTOR

- Features separable "snap-on/snap-off" battery connector (9 Volt type) to assure reliable connections to battery powered equipment, controls and systems
- Economical design, holders available for two, three or four cells. Wired in series to accept connector (9 Volt type)
- Batteries securely held in place to maintain a positive contact and a low contact resistance

- Battery contact springs self adjust to variations in battery length
- Withstands shock and vibration
- Ideally mates with Keystone 9 Volt battery straps and connectors

SPECIFICATIONS

Holder: Polypropylene; **Male/Female Contacts:** Brass, Nickel Plate
Battery Springs: Spring Steel, Nickel Plate

Holds Two (2) "AA" Cells in Series

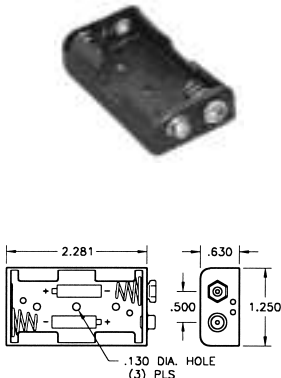

CAT. NO. 2474

Holds Three (3) "AA" Cells in Series

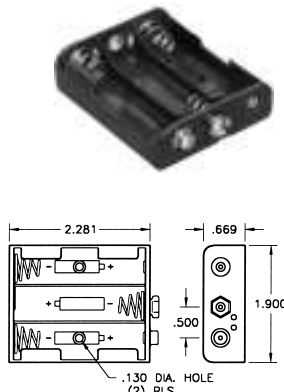

CAT. NO. 2475

Holds Four (4) "AA" Cells in Series

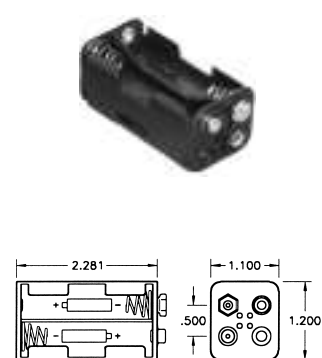

CAT. NO. 2476