



HESTORE.HU

elektronikai alkatrész áruház

EN: This Datasheet is presented by the manufacturer.

Please visit our website for pricing and availability at www.hestore.hu.

10 cm Breitbandlautsprecher / 4" Fullrange Speakers

Art. No. 2020 – 4 Ω Art. No. 2021 – 8 Ω FR 10

10 cm (4") Breitbandlautsprecher mit guten Tieftoneigenschaften, ausgeglichenem Frequenzgang und hohem Wirkungsgrad. Besonders geeignet als Einbaulautsprecher für die Musikwiedergabe sowie zur Bestückung von ELA-Zeilen. **Zubehör:** Schutzgitter (Art. No. 4642, 4640, 4670, 4744)

Anwendungsmöglichkeiten: ELA-Zeilen, Deckenlautsprecher in Schienenfahrzeugen und Bussen, Car-HiFi Einbaulautsprecher, Elektronische Musikinstrumente

10 cm (4") fullrange speaker with good bass reproduction, balanced frequency response and high efficiency. Especially suitable as built-in speaker for music reproduction and as driver for 100 V network column speakers. **Accessories:** Protective grille (Art. No. 4642, 4640, 4670, 4744)

Typical applications: Network column speakers, Ceiling-mounted speakers in railway carriages and busses, Built-in car hi-fi speakers, Electronic musical instruments

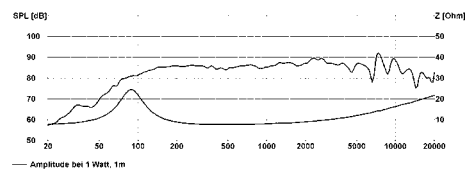
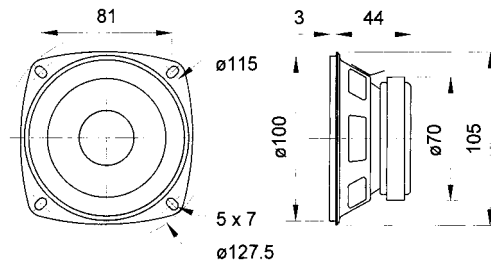
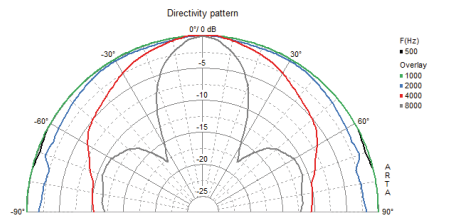
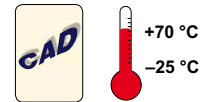

Art. No. 4744



Art. No. 4670



Art. No. 4640



Art. No. 4642

Art. No. 4898 – 4 Ω Art. No. 4899 – 8 Ω FR 10 HM

10 cm (4") Breitbandlautsprecher mit Hochtongel und Euro-Normkorb. Einfache Montage in Fahrzeugen mit Einbauorten für 10-cm-Lautsprecher.

Anwendungsmöglichkeiten:

- Fahrzeuge
- Reisemobile

Zubehör: Schutzgitter (Art. No. 4642, 4640, 4744)

10 cm (4") fullrange speaker with tweeter cone and European standard basket. Simple fitting in vehicles with cut-outs for 10 cm speakers.

Typical applications:

- Vehicles
- Mobile homes

Accessories: Protective grille (Art. No. 4642, 4640, 4744)

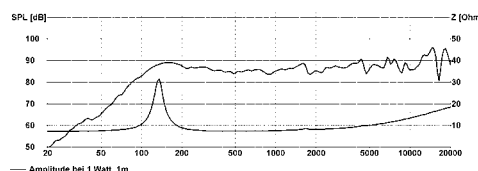
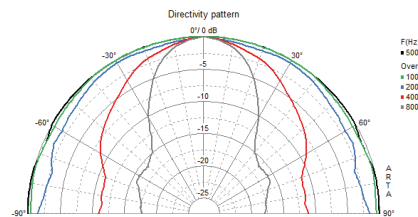
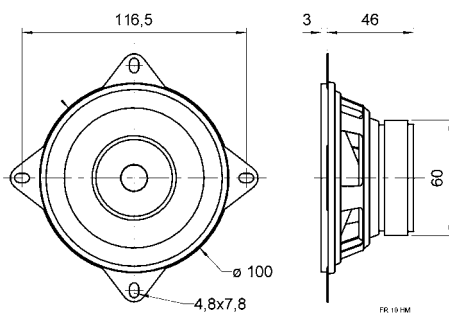
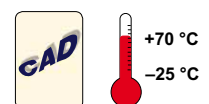

Art. No. 4640



Art. No. 4642



Art. No. 4744

		FR 10	FR 10 HM
Nenn-/Musikbelastbarkeit	Rated/maximum power	20 W / 30 W	20 W / 30 W
Impedanz	Impedance	4 Ω/8 Ω	4 Ω/8 Ω
Übertragungsbereich (-10 dB)	Frequency response (-10 dB)	80-20000 Hz	95-22000 Hz
Mittlerer Schalldruckpegel	Mean sound pressure level	86 dB (1 W/1 m)	86 dB (1 W/1 m)
Grenzauslenkung x	Excursion limit x	± 4 mm	± 2 mm
Resonanzfrequenz	Resonance frequency	92 Hz/88 Hz	120 Hz
Obere Polplattenhöhe	Height of front pole-plate	3 mm	2 mm
Schwingspulendurchmesser	Voice coil diameter	20 mm Ø	14 mm Ø
Wickelhöhe	Height of winding	6 mm	5 mm
Schallwandöffnung	Cutout diameter	100 mm Ø	94 mm Ø
Gewicht netto	Net weight	0,38 kg	0,34 kg

Weitere Daten Seiten 156-157 / for further data see pages 156-157