



**HESTORE.HU**

elektronikai alkatrész áruház

**EN:** This Datasheet is presented by the manufacturer.

Please visit our website for pricing and availability at [www.hestore.hu](http://www.hestore.hu).

# DTMSS-40 SENDUST POWER INDUCTORS



## APPLICATIONS:

- interference suppressing chokes (DC - 300kHz)
- energy storage inductors (DC - 300kHz)
- DC/DC converters
- SMPS
- EMI filters (DC - 1 MHz)
- acoustic filters

## ORDERING CODE:

DTMSS- 40 / 4,7 / 0,5 -V

mounting: V - vertical, H - horizontal, BV - base vertical,  
 CH - case horizontal  
 rated current in Amps  
 inductance in mH@ $I_{DC} = 0A$   
 sendust core outer diameter  
 product symbol

## DIMENSIONS:

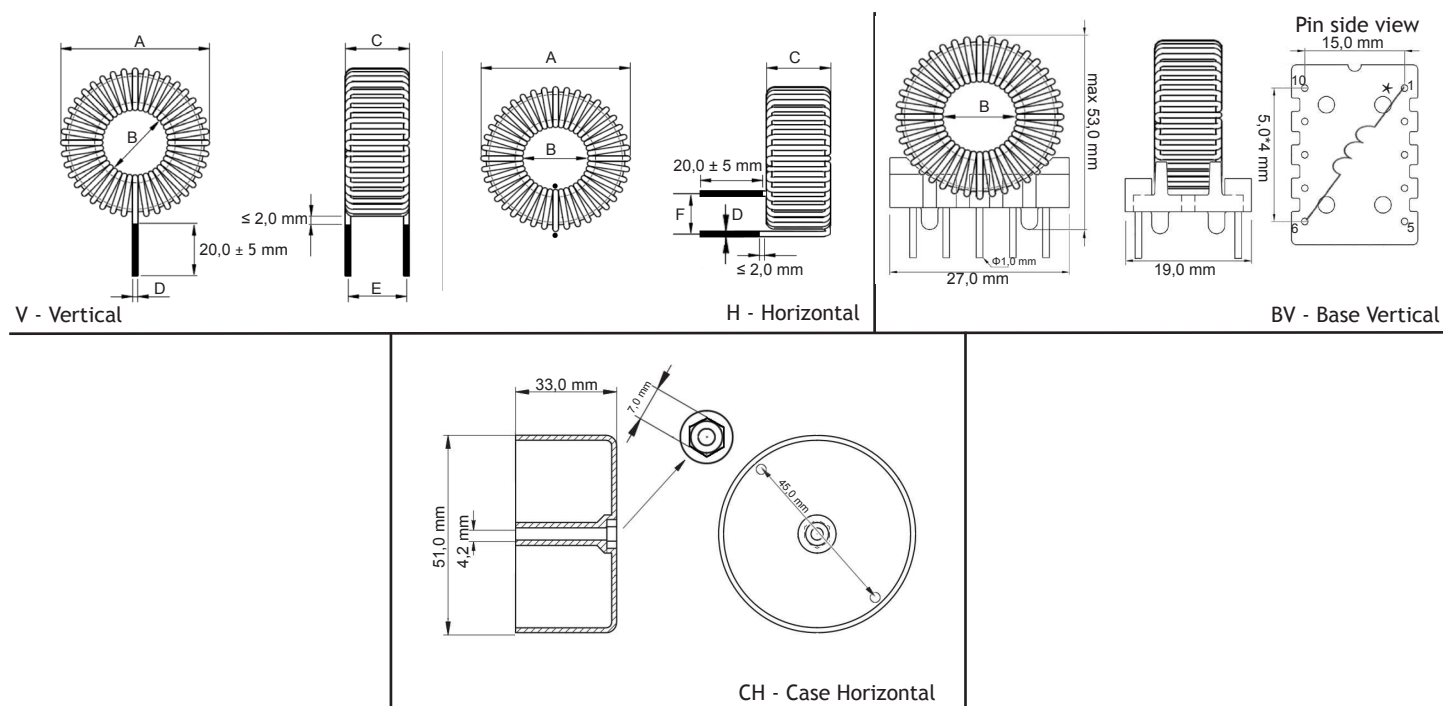

Part number	Type - core dimension ( $\pm 10\%$ )						Mounting version			
	A [mm]	B [mm]	C [mm]	D [mm]	E [mm]	F [mm]	V	H	BV	CH
DTMSS-40/4,7/0,5	41,5	22,0	16,0	0,25	17,0	9,5	✓	✓	✓	–
DTMSS-40/3,3/0,7	42,0	21,5	16,5	0,30	17,0	9,5	✓	✓	✓	–
DTMSS-40/2,2/1,2	42,5	21,0	17,0	0,40	17,5	10,0	✓	✓	✓	–
DTMSS-40/1,5/1,6	42,5	20,5	17,0	0,45	17,5	10,0	✓	✓	✓	–
DTMSS-40/1,0/2,4	43,0	19,5	17,5	0,75	17,5	12,5	✓	✓	✓	–
DTMSS-40/0,68/4,0	44,0	18,0	18,5	1,05	18,5	12,5	✓	✓	✓	–
DTMSS-40/0,47/6,0	44,5	17,0	19,0	1,15	18,5	13,0	✓	✓	✓	–
DTMSS-40/0,33/8,0	45,0	16,5	19,0	1,55	18,5	13,0	✓	✓	–	✓
DTMSS-40/0,22/10	45,5	16,0	19,5	1,60	19,5	14,0	✓	✓	–	✓
DTMSS-40/0,15/15	46,5	15,0	20,5	1,90	20,5	16,5	✓	✓	–	✓
DTMSS-40/0,10/20	47,0	12,5	21,0	2,50	21,0	17,0	✓	✓	–	✓
DTMSS-40/0,068/30	47,0	12,5	21,0	2,90	21,0	17,0	✓	✓	–	✓
DTMSS-40/0,047/45	47,5	10,0	23,5	3,90	24,0	18,5	✓	✓	–	✓

**ELECTRICAL PROPERTIES:**

Part number	Lmax [μH]	I <sub>max</sub> [A]	L@I <sub>max</sub> [μH]	RDC [Ω]	Δt [°C]
DTMSS-40/4,7/0,5	4700	0,50	4520	3,31	10,5
DTMSS-40/3,3/0,7	3300	0,70	3130	2,33	13,3
DTMSS-40/2,2/1,2	2200	1,00	2060	1,20	13,7
DTMSS-40/1,5/1,6	1500	1,60	1330	0,611	17,2
DTMSS-40/1,0/2,4	1000	2,40	852	0,309	19,4
DTMSS-40/0,68/4,0	680	4,00	511	0,223	31,5
DTMSS-40/0,47/6,0	470	6,00	313	0,112	35,7
DTMSS-40/0,33/8,0	330	8,00	205	0,0574	33,3
DTMSS-40/0,22/10	220	10,0	136	0,0408	33,8
DTMSS-40/0,15/15	150	15,0	78,7	0,0208	38,0
DTMSS-40/0,10/20	100	20,0	47,1	0,0107	33,8
DTMSS-40/0,068/30	68	30,0	26,1	0,00762	46,7
DTMSS-40/0,047/45	47	45,0	13,9	0,00389	54,6

**CHARACTERISTICS:**

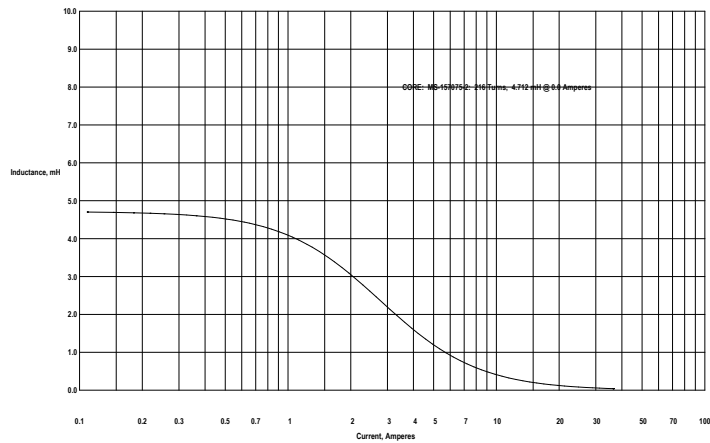

CREATED IN MICROMETALS ARNOLD POWDER CORES - DESIGN OF INDUCTORS FOR POWER FILTER APPLICATIONS Mon Nov 28 09:30:51 2011

DTMSS-40/4,7/0,5

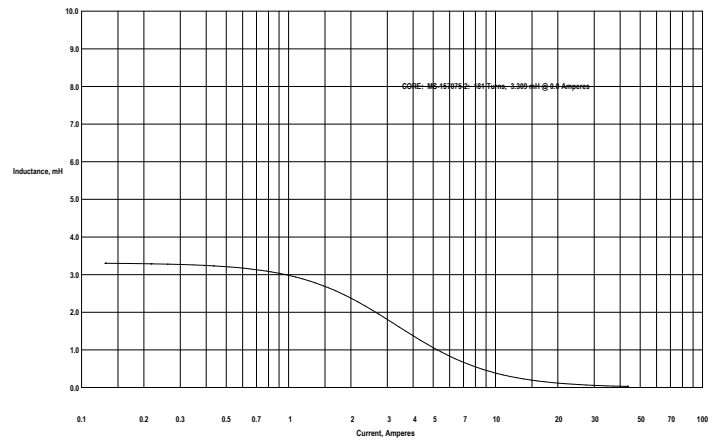

CREATED IN MICROMETALS ARNOLD POWDER CORES - DESIGN OF INDUCTORS FOR POWER FILTER APPLICATIONS Mon Nov 28 09:32:06 2011

DTMSS-40/3,3/0,7

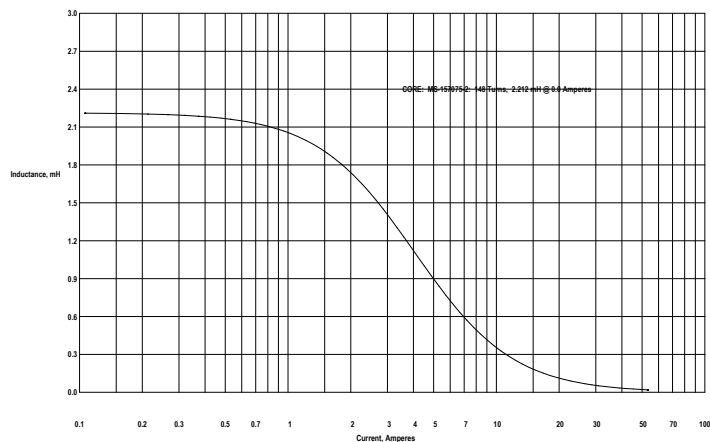

CREATED IN MICROMETALS ARNOLD POWDER CORES - DESIGN OF INDUCTORS FOR POWER FILTER APPLICATIONS Mon Nov 28 09:35:02 2011

DTMSS-40/2,2/1,2

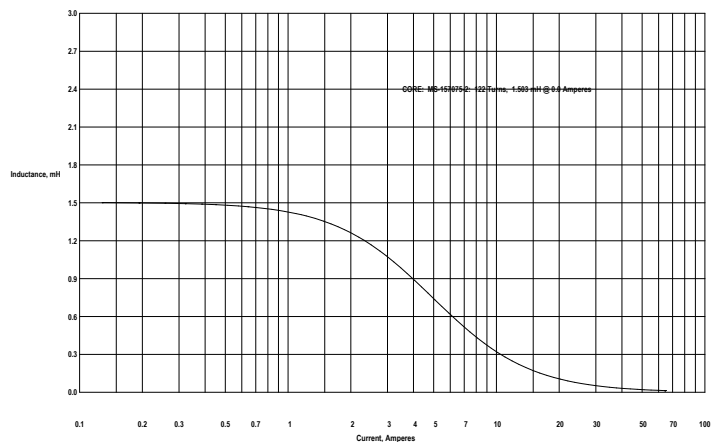

CREATED IN MICROMETALS ARNOLD POWDER CORES - DESIGN OF INDUCTORS FOR POWER FILTER APPLICATIONS Mon Nov 28 09:36:04 2011

DTMSS-40/1,5/1,6

**CHARACTERISTICS:**

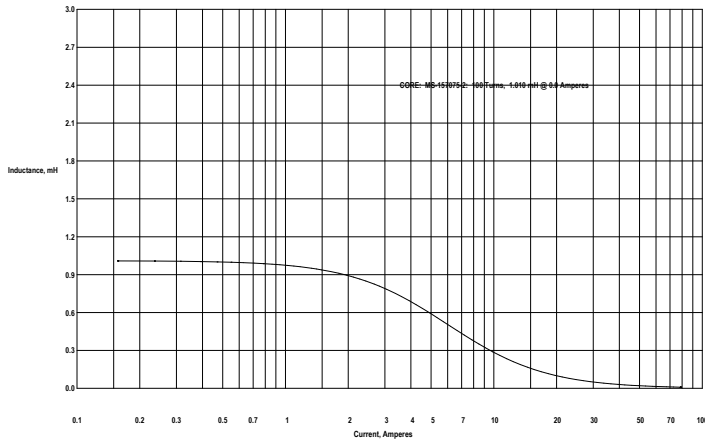

CREATED IN MICROMETALS ARNOLD POWDER CORES - DESIGN OF INDUCTORS FOR POWER FILTER APPLICATIONS Mon Nov 28 09:37:06 2011

DTMS-40/1/2,4

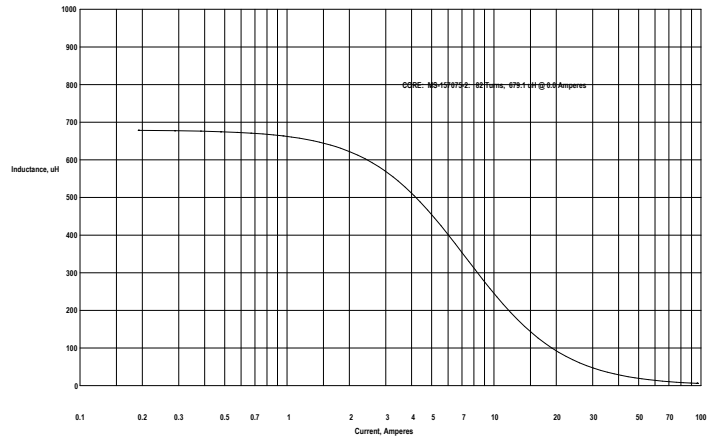

CREATED IN MICROMETALS ARNOLD POWDER CORES - DESIGN OF INDUCTORS FOR POWER FILTER APPLICATIONS Mon Nov 28 09:39:38 2011

DTMS-40/0,68/4,0

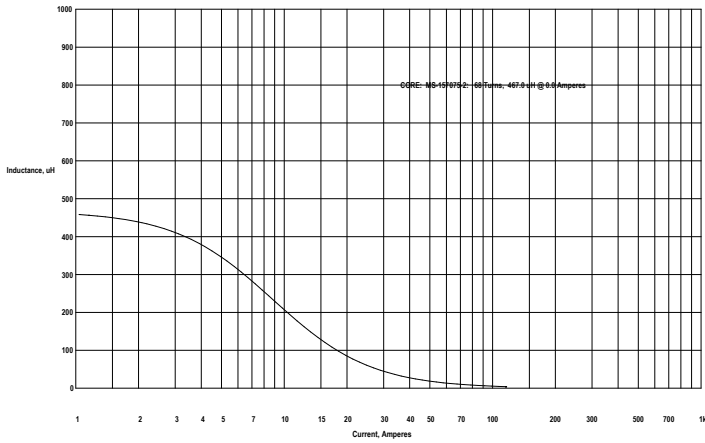

CREATED IN MICROMETALS ARNOLD POWDER CORES - DESIGN OF INDUCTORS FOR POWER FILTER APPLICATIONS Mon Nov 28 09:40:53 2011

DTMS-40/0,47/6,0

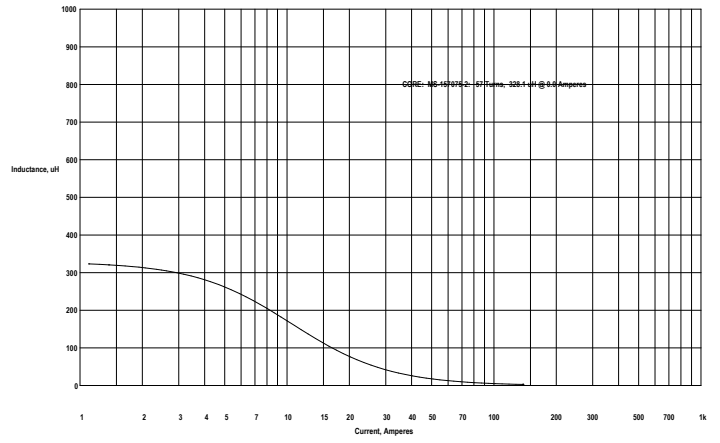

CREATED IN MICROMETALS ARNOLD POWDER CORES - DESIGN OF INDUCTORS FOR POWER FILTER APPLICATIONS Mon Nov 28 09:42:38 2011

DTMS-40/0,33/8,0

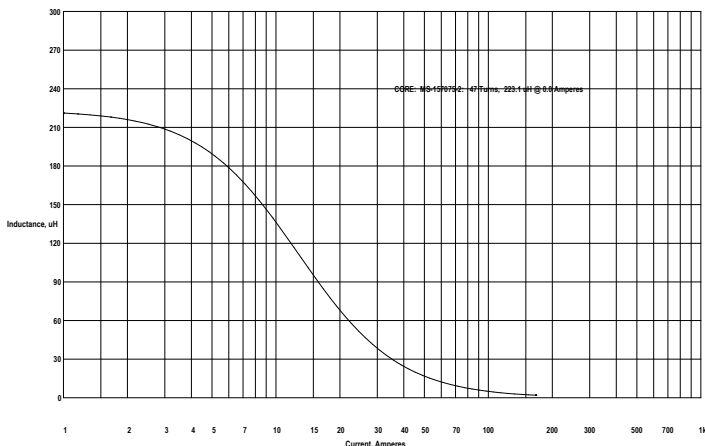

CREATED IN MICROMETALS ARNOLD POWDER CORES - DESIGN OF INDUCTORS FOR POWER FILTER APPLICATIONS Mon Nov 28 09:45:17 2011

DTMS-40/0,22/10

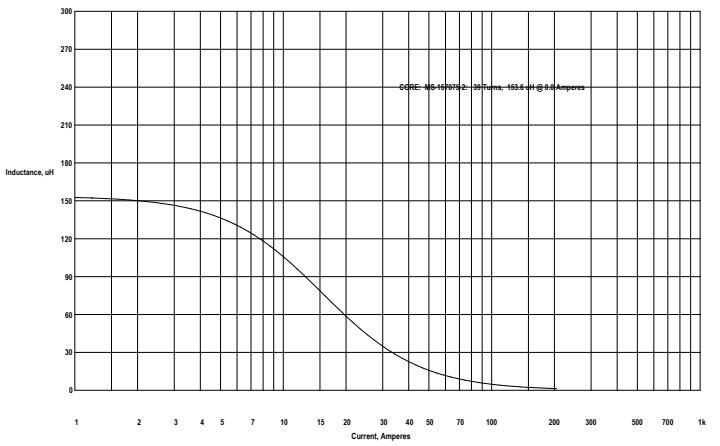

CREATED IN MICROMETALS ARNOLD POWDER CORES - DESIGN OF INDUCTORS FOR POWER FILTER APPLICATIONS Mon Nov 28 09:45:17 2011

DTMS-40/0,15/15

**CHARACTERISTICS:**

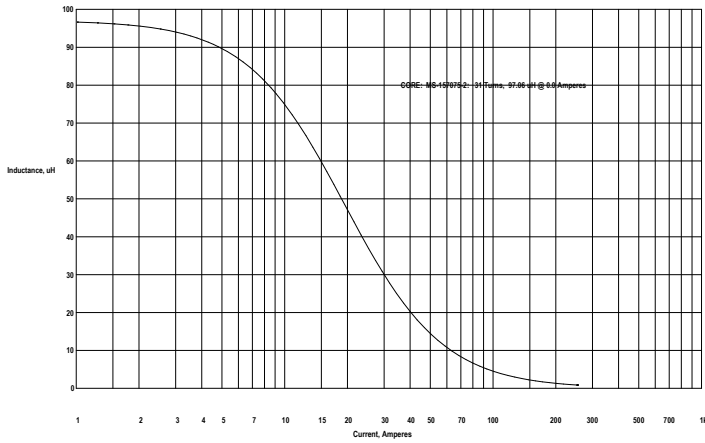

CREATED IN MICROMETALS ARNOLD POWDER CORES - DESIGN OF INDUCTORS FOR POWER FILTER APPLICATIONS Mon Nov 28 09:47:38 2011

DTMS-40/0,1/20

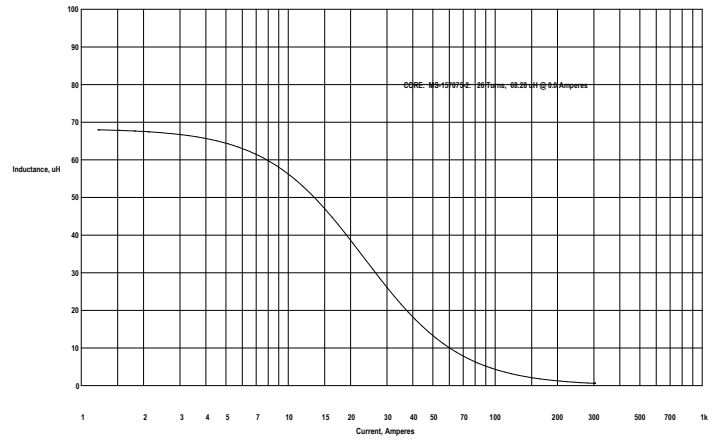

CREATED IN MICROMETALS ARNOLD POWDER CORES - DESIGN OF INDUCTORS FOR POWER FILTER APPLICATIONS Mon Nov 28 09:50:49 2011

DTMS-40/0,068/30

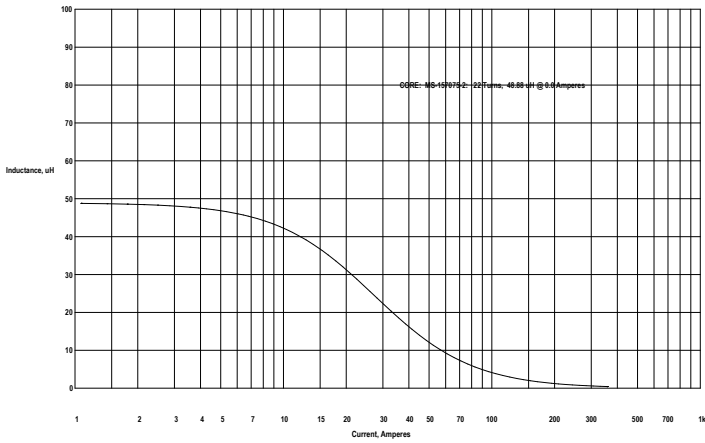

CREATED IN MICROMETALS ARNOLD POWDER CORES - DESIGN OF INDUCTORS FOR POWER FILTER APPLICATIONS Mon Nov 28 09:52:05 2011

DTMS-40/0,047/45