



**HESTORE.HU**

elektronikai alkatrész áruház

**EN:** This Datasheet is presented by the manufacturer.

Please visit our website for pricing and availability at [www.hestore.hu](http://www.hestore.hu).

# mikroProg™ for AVR®

mikroProg™ for AVR® is a fast USB programmer. With it's outstanding performance, simplicity and unique design it is a great tool for programming Atmel® AVR microcontroller family.



# TO OUR VALUED CUSTOMERS

I want to express my thanks to you for being interested in our products and for having confidence in MikroElektronika.

The primary aim of our company is to design and produce high quality electronic products and to constantly improve the performance thereof in order to better suit your needs.

A white handwritten signature in cursive script, appearing to read 'N. Matic', set against a blue background.

Nebojsa Matic  
General Manager

# Table of Contents

Introduction to mikroProg™	4	2. Connecting to a PC	9
Key features	5	3. AVRFlash software	10
1. Driver installation	6	4. Connecting with a target device	12
step 1 - Start installation	7	5. Connector Pinout	13
step 2 - Accept EULA	7	6. Connection schematic example	14
step 3 - Installing the drivers	8	40-pin ATmega16 schematic	15
step 4 - Finish installation	8		

# Introduction to mikroProg™



**mikroProg™ for AVR®** is a fast USB programmer. It is a great tool for programming Atmel® AVR microcontroller family. Outstanding performance, easy operation, elegant design and low price are its top features.

# Key features

## What you see

- 01 Flat cable
- 02 USB MINIB connector
- 03 DATA transfer indication LED
- 04 ACTIVE indication LED
- 05 LINK indication LED
- 06 POWER indication LED



# 1. Driver installation

mikroProg™ requires drivers in order to work. Drivers are located on the **Product DVD** that you received with the mikroProg™ package:



*DVD://download/eng/software/  
development-tools/avr/avr-  
prog2/avrprog2\_drivers\_v200.  
zip*

When you locate the drivers, please extract files from the ZIP archive. Folder with extracted files contains folders with drivers for different operating systems. Depending on which operating system you use, choose adequate folder and open it.



avrprog2\_drivers\_v200  
WinRAR ZIP archive  
1.51 MB



Windows 7 32 bit,  
Vista 32bit, Win  
2008 32 bit



Windows 7 64 bit,  
Vista 64bit, Win  
2008 64 bit



Win 2000, XP,  
2003 32-bit



Win 98



Win XP, 2003  
64-bit

In the opened folder you should be able to locate the driver setup file. Double click on setup file to begin installation of the programmer drivers.



USB18PRG-Vista-  
x64

## step 1 - Start installation

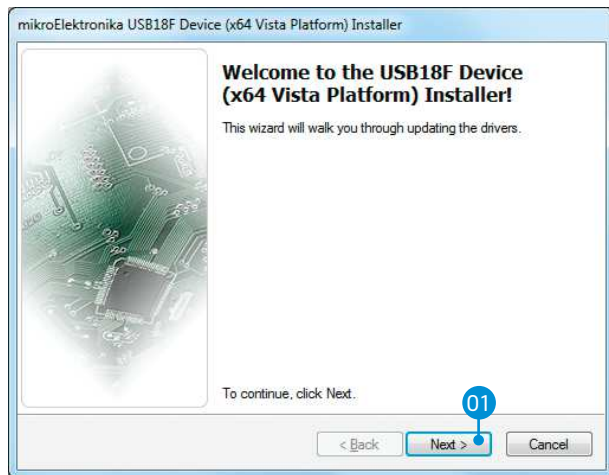

- 01 In welcome screen click the **Next >** button

## step 2 - Accept EULA

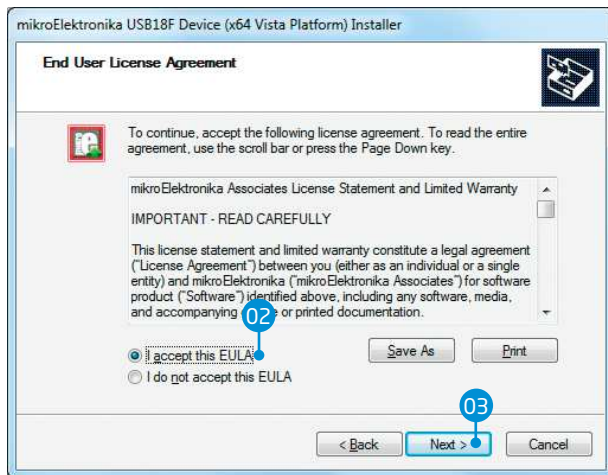

- 02 Select **I accept this EULA** option
- 03 Click the **Next >** button



## step 3 - Installing the drivers

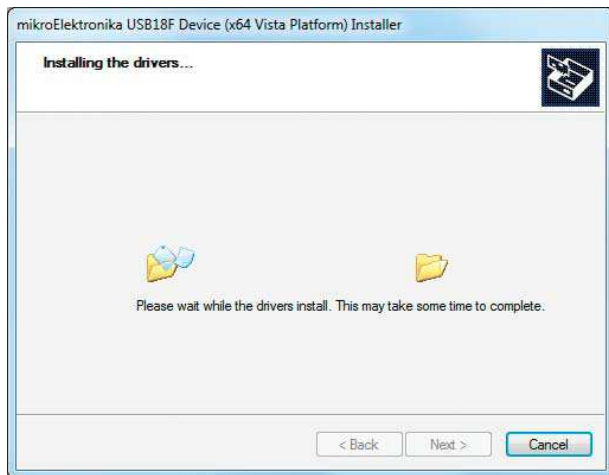

## step 4 - Finish installation

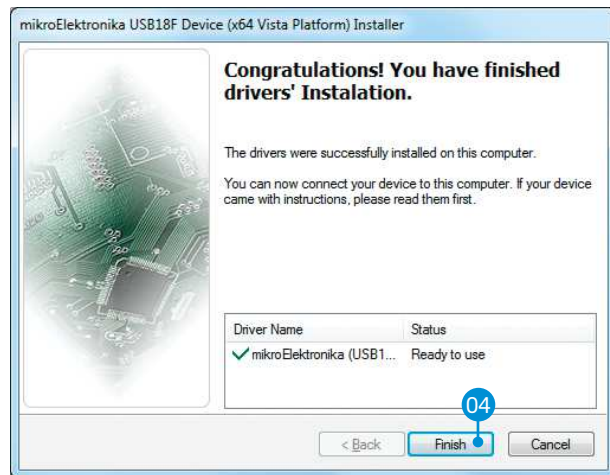

04 Click the **Finish** button to end installation process

## 2. Connecting to a PC

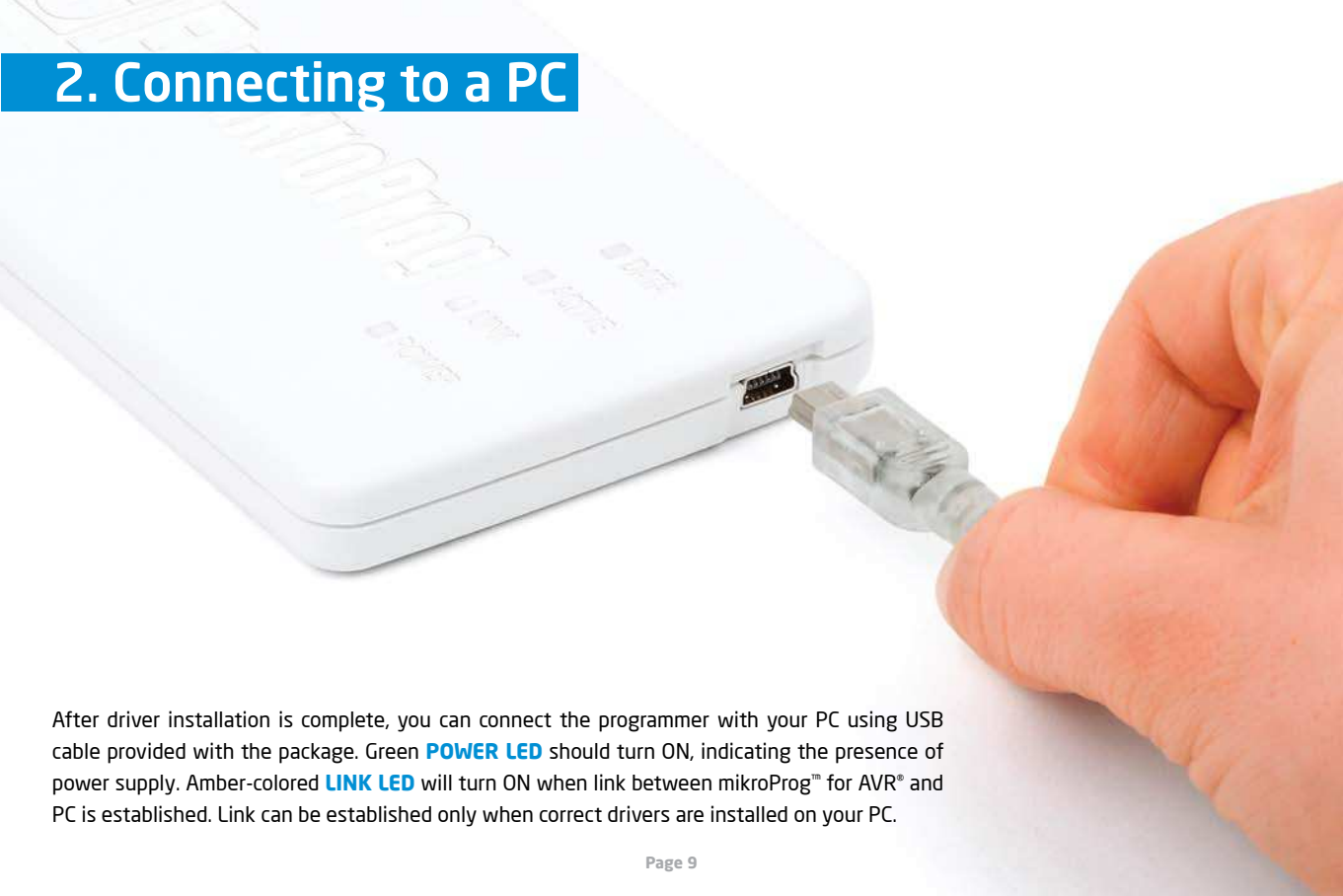

After driver installation is complete, you can connect the programmer with your PC using USB cable provided with the package. Green **POWER LED** should turn ON, indicating the presence of power supply. Amber-colored **LINK LED** will turn ON when link between mikroProg™ for AVR® and PC is established. Link can be established only when correct drivers are installed on your PC.

# 3. AVRFlash software

mikroProg™ for AVR® programmer requires special programming software called AVRFlash. This software is used for programming AVR® microcontrollers from Atmel®. It features intuitive interface and SingleClick™ programming technology.

Software installation comes on a Product

DVD:



*DVD://download/eng/software/  
development-tools/avr/avrprog2/  
avrprog2\_programmer\_v214.zip*

After downloading, extract the package and double click the executable setup file, to start installation.



avrprog2\_programmer\_v214  
WinRAR ZIP archive  
2.03 MB



AVRFlash\_v214\_setup  
1/29/2013 2:24 PM  
2.06 MB

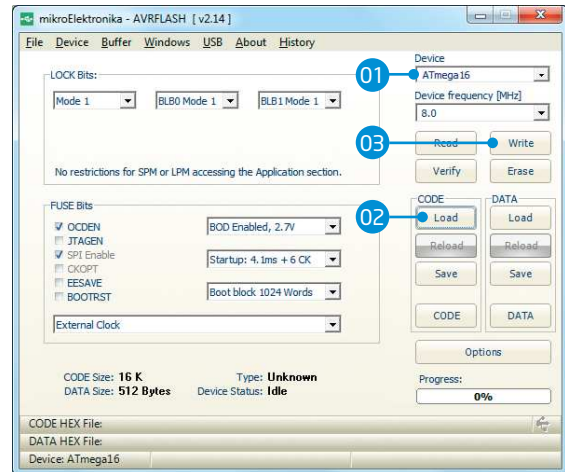

Figure 3-1: AVRFlash software window

## Quick Guide

- 01 Select the microcontroller to be programmed
- 02 Click the **Load** button to open pop-up window and select the .hex code to be loaded in microcontroller
- 03 Click the **Write** option to start programming

# Software installation wizard



01 Start Installation



02 Accept EULA and continue



03 Click Next > button

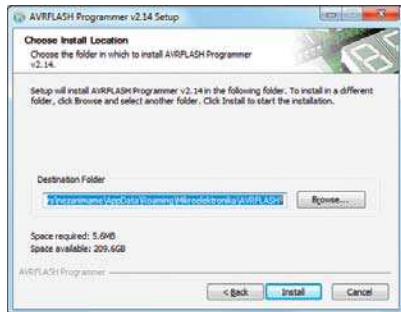

04 Choose destination folder



05 Installation in progress



06 Finish installation

## 4. Connecting with a target device

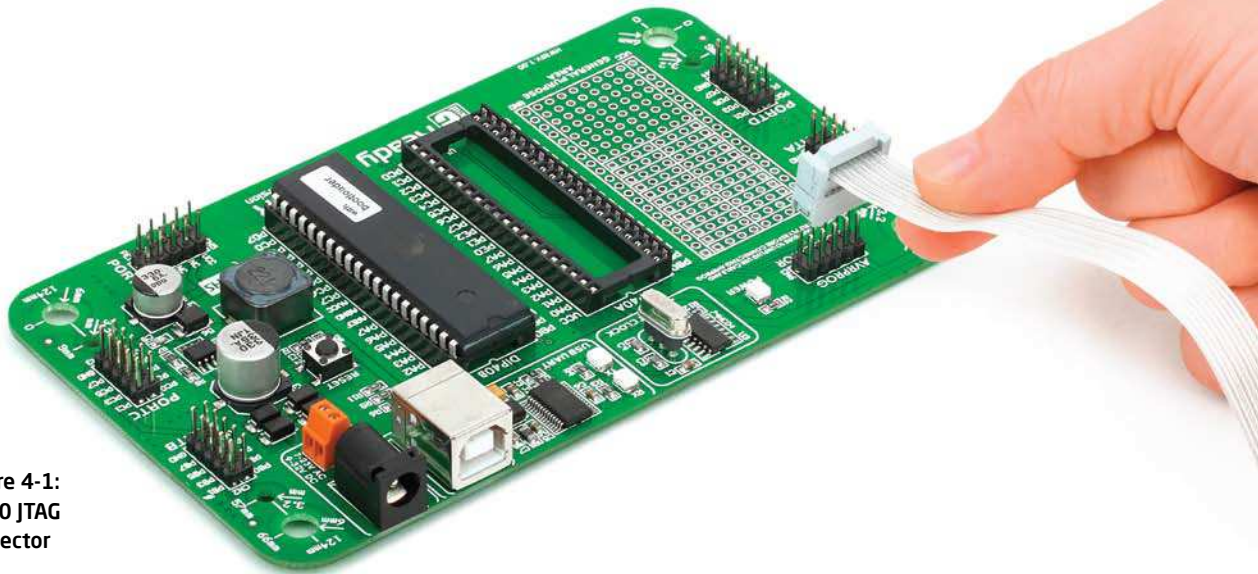

Figure 4-1:  
IDC10 JTAG  
connector

For connection with a target device mikroProg™ uses IDC10 connector, as shown on **Figure 4-1**. In order to make proper connection with the target board it is necessary to pay attention to IDC10 connector pinout. Every pin has a different purpose and for easy orientation IDC10 connector is marked with a little knob and incision between pins number 9 and 7, **Figure 5-1**.

# 5. Connector Pinout

- 01 **MOSI** - Master output slave input
- 03 **NC** - Not connected
- 05 **RST** - Reset pin
- 07 **SCK** - Clock
- 09 **MISO** - Master input slave output
  
- 02 **VCC** - Power supply
- 04 **NC** - Not connected
- 06 **NC** - Not connected
- 08 **NC** - Not connected
- 10 **GND** - Ground

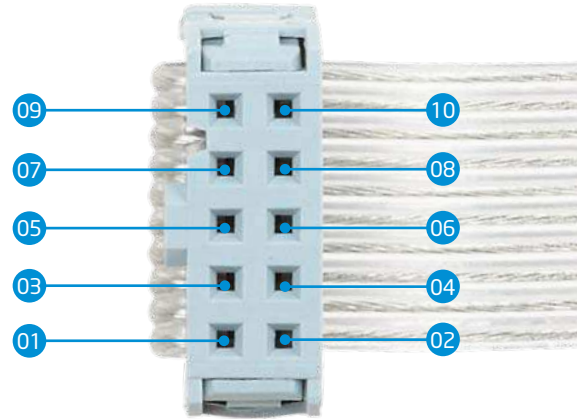
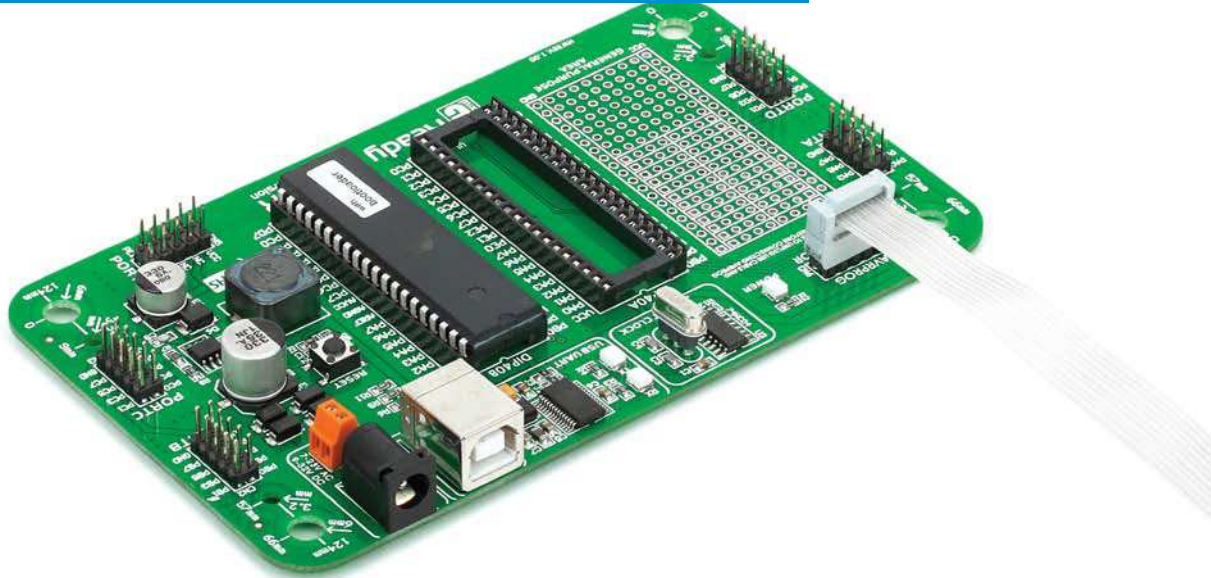

Figure 5-1: Female connector pinout

## 6. Connection schematic example



Following example demonstrate connections with one of the most popular supported microcontroller. MCU use MISO, MOSI, SCK and RST lines for programming. In order for microcontroller to work properly, decoupling capacitors must be connected as close as possible to microcontroller's VCC pins. Whichever microcontroller you decide to use, make sure to connect each pin properly.

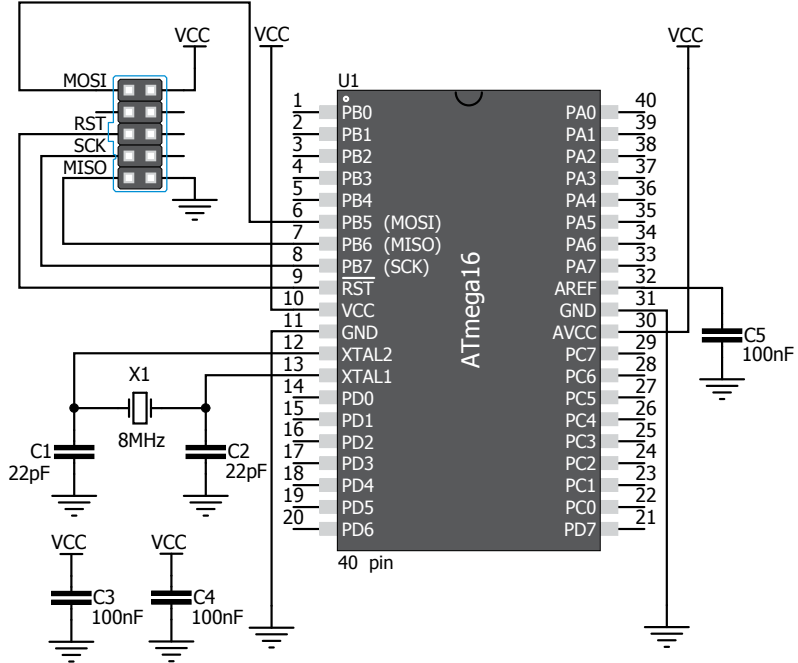
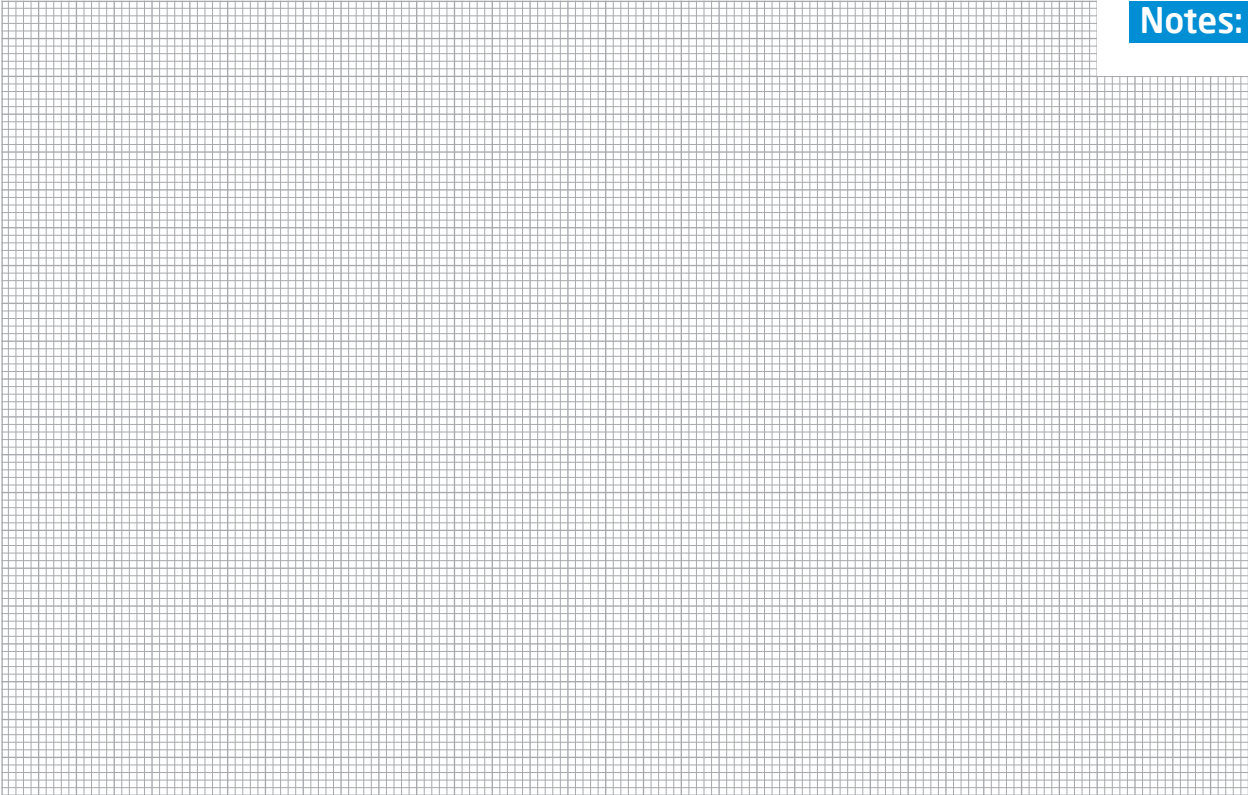

Figure 6-1: Connection schematic for 40-pin ATmega16 MCU via 2x5 male header



Notes:



Notes:

## DISCLAIMER

All the products owned by MikroElektronika are protected by copyright law and international copyright treaty. Therefore, this manual is to be treated as any other copyright material. No part of this manual, including product and software described herein, may be reproduced, stored in a retrieval system, translated or transmitted in any form or by any means, without the prior written permission of MikroElektronika. The manual PDF edition can be printed for private or local use, but not for distribution. Any modification of this manual is prohibited.

MikroElektronika provides this manual 'as is' without warranty of any kind, either expressed or implied, including, but not limited to, the implied warranties or conditions of merchantability or fitness for a particular purpose.

MikroElektronika shall assume no responsibility or liability for any errors, omissions and inaccuracies that may appear in this manual. In no event shall MikroElektronika, its directors, officers, employees or distributors be liable for any indirect, specific, incidental or consequential damages (including damages for loss of business profits and business information, business interruption or any other pecuniary loss) arising out of the use of this manual or product, even if MikroElektronika has been advised of the possibility of such damages. MikroElektronika reserves the right to change information contained in this manual at any time without prior notice, if necessary.

## HIGH RISK ACTIVITIES

The products of MikroElektronika are not fault - tolerant nor designed, manufactured or intended for use or resale as on - line control equipment in hazardous environments requiring fail - safe performance, such as in the operation of nuclear facilities, aircraft navigation or communication systems, air traffic control, direct life support machines or weapons systems in which the failure of Software could lead directly to death, personal injury or severe physical or environmental damage ('High Risk Activities'). MikroElektronika and its suppliers specifically disclaim any expressed or implied warranty of fitness for High Risk Activities.

## TRADEMARKS

The MikroElektronika name and logo, the MikroElektronika logo, mikroC™, mikroBasic™, mikroPascal™, mikroProg™, EasyAVR™, mikromedia™ and Ready™ are trademarks of MikroElektronika. All other trademarks mentioned herein are property of their respective companies.

All other product and corporate names appearing in this manual may or may not be registered trademarks or copyrights of their respective companies, and are only used for identification or explanation and to the owners' benefit, with no intent to infringe.



If you want to learn more about our products, please visit our website at [www.mikroe.com](http://www.mikroe.com)

If you are experiencing some problems with any of our products or just need additional information, please place your ticket at [www.mikroe.com/esupport](http://www.mikroe.com/esupport)

If you have any questions, comments or business proposals,  
do not hesitate to contact us at [office@mikroe.com](mailto:office@mikroe.com)

mikroProg for AVR Manual  
ver. 1.00



0 100000 023273