



HESTORE.HU

elektronikai alkatrész áruház

EN: This Datasheet is presented by the manufacturer.

Please visit our website for pricing and availability at www.hestore.hu.

5mm Standard T-1 3/4 Type Full Color
With Common Anode LED
Technical Data Sheet

Part No.: LL-509RGBM2E-004

Features:

- ◇ Uniform light output.
- ◇ Low power consumption.
- ◇ I.C. Compatible.
- ◇ Long life-solid state reliability.
- ◇ The product itself will remain within RoHS compliant Version.

Descriptions:

- ◇ The Hyper Red source color devices are made with AlGaInP on GaAs substrate Light Emitting Diode.
- ◇ The Pure Green source color devices are made with InGaN on Sapphire substrate Light Emitting Diode.
- ◇ The Blue source color devices are made with InGaN on Sapphire substrate Light Emitting Diode.

Applications:

- ◇ TV set.
- ◇ Monitor.
- ◇ Telephone.
- ◇ Computer.
- ◇ Circuit board, etc.

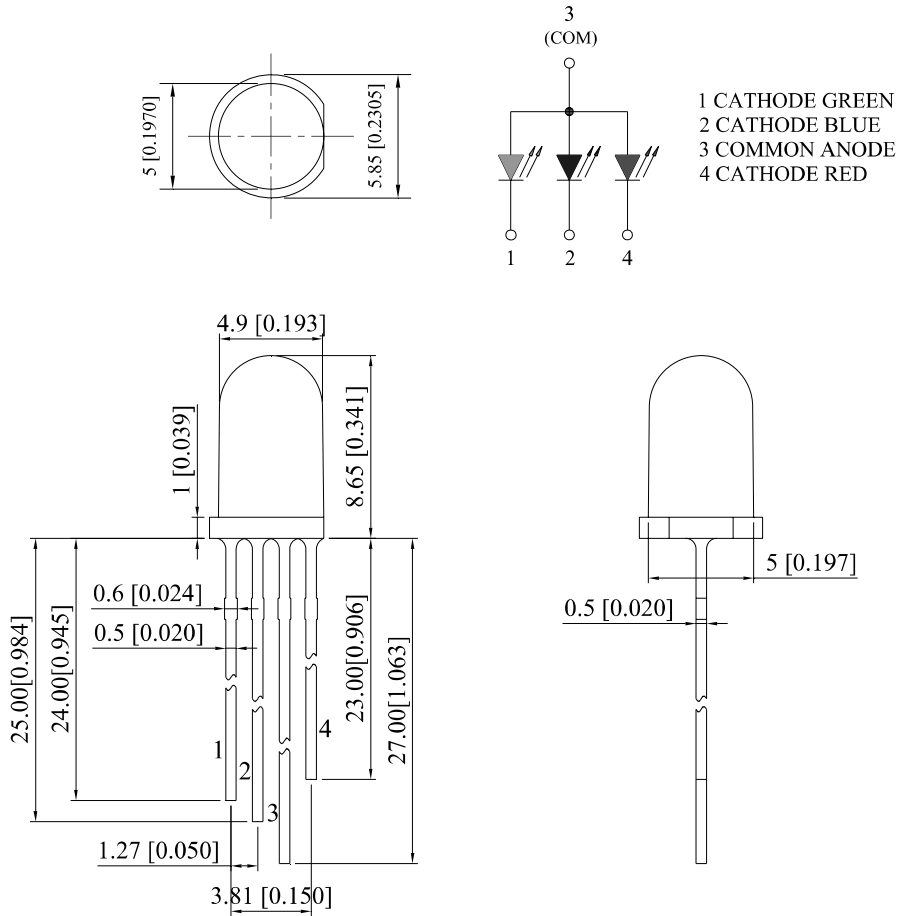
Package Dimension:

Part No.	Chip Material	Lens Color	Source Color
LL-509RGBM2E-004	AlGaInP	White Diffused	Hyper Red
	InGaN		Pure Green
	InGaN		Blue

Notes:

1. All dimensions are in millimeters (inches).
2. Tolerance is $\pm 0.25\text{mm}$ (.010") unless otherwise noted.
3. Protruded resin under flange is 1.00mm (.039") max.
4. Specifications are subject to change without notice.

Absolute Maximum Ratings at Ta=25°C

Parameters	Emitting Color	Symbol	Max.	Unit
Power Dissipation	Hyper Red	PD	65	mW
	Pure Green		100	
	Blue		100	
Peak Forward Current (1/10 Duty Cycle, 0.1ms Pulse Width)		IFP	100	mA
Forward Current	Hyper Red	IF	25	mA
	Pure Green	IF	25	mA
	Blue	IF	25	mA
Reverse Voltage		VR	5	V
Operating Temperature Range		Topr	-40°C to +85°C	
Storage Temperature Range		Tstg	-40°C to +100°C	
Lead Soldering Temperature [4mm (.157") From Body]		Tsld	260°C for 5 Seconds	

Electrical Optical Characteristics at Ta=25°C

Parameters	Symbol	Emitting Color	Min.	Typ.	Max.	Unit	Test Condition
Luminous Intensity *	IV	Hyper Red	350	600	---	mcd	IF=20mA (Note 1)
		Pure Green	450	1000	---		
		Blue	250	500	---		
Viewing Angle *	$2\theta_{1/2}$	Hyper Red	---	60	---	Deg	IF=20mA (Note 2)
		Pure Green	---	60	---		
		Blue	---	60	---		
Peak Emission Wavelength	λ_p	Hyper Red	---	632	---	nm	IF=20mA
		Pure Green	---	520	---		
		Blue	---	468	---		
Dominant Wavelength	λ_d	Hyper Red	---	624	---	nm	IF=20mA (Note 3)
		Pure Green	---	525	---		
		Blue	---	470	---		
Forward Voltage	VF	Hyper Red	1.60	2.20	2.60	V	IF=20mA
		Pure Green	2.80	3.50	4.00		
		Blue	2.80	3.50	4.00		
Reverse Current	IR	Hyper Red	---	---	10	μ A	$V_R=5V$
		Pure Green	---	---	10		
		Blue	---	---	10		

Notes:

- Luminous Intensity Measurement allowance is $\pm 10\%$.
- $\theta_{1/2}$ is the off-axis angle at which the luminous intensity is half the axial luminous intensity.
- The dominant wavelength (λ_d) is derived from the CIE chromaticity diagram and represents the single wavelength which defines the color of the device.

Typical Electrical / Optical Characteristics Curves
 (25°C Ambient Temperature Unless Otherwise Noted)

Hyper Red:

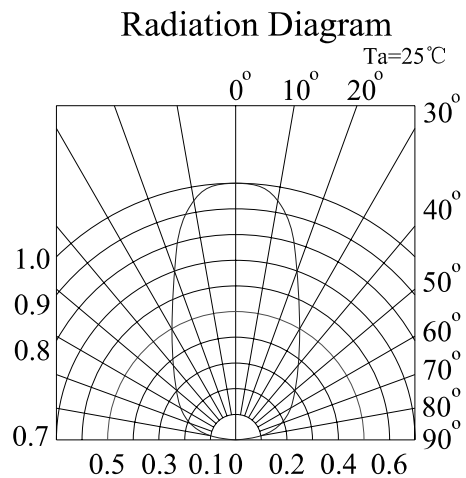
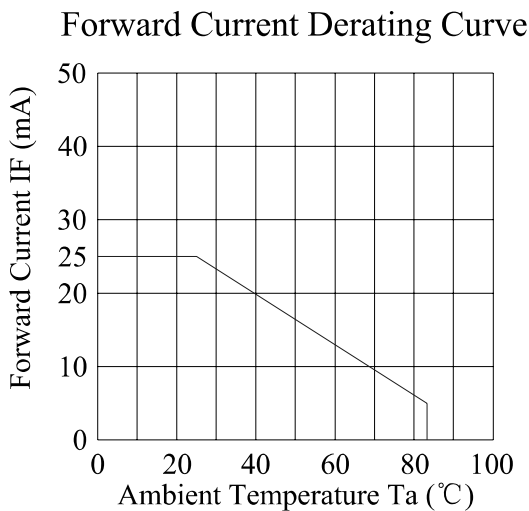
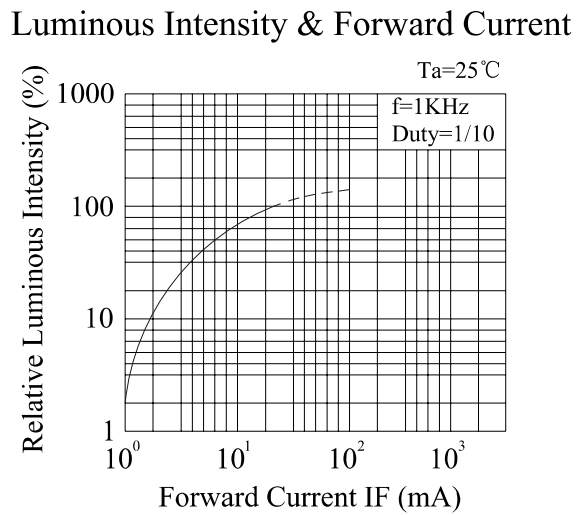
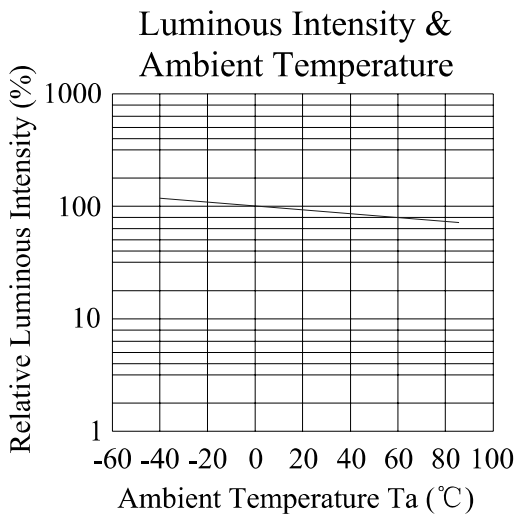
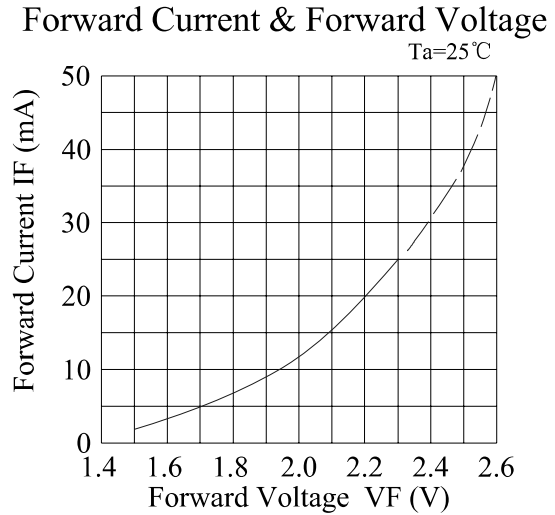
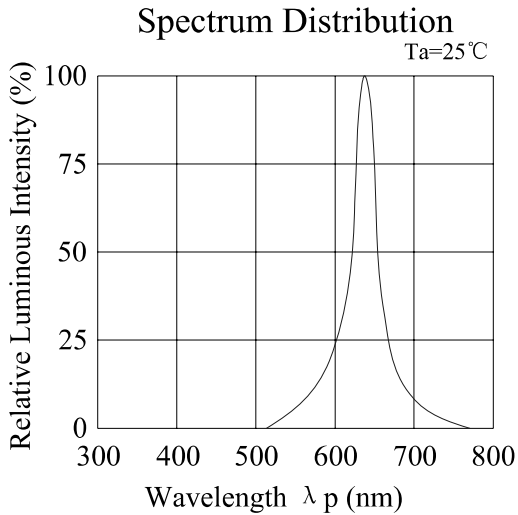

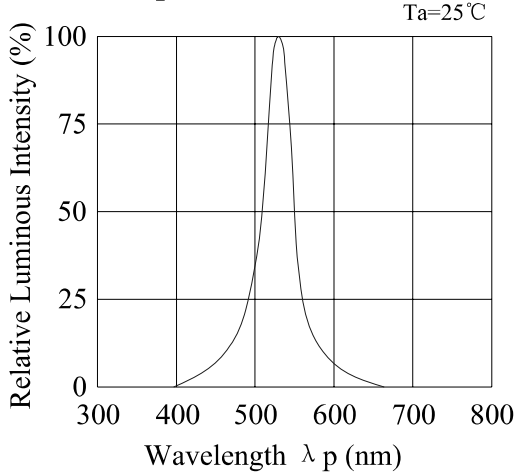
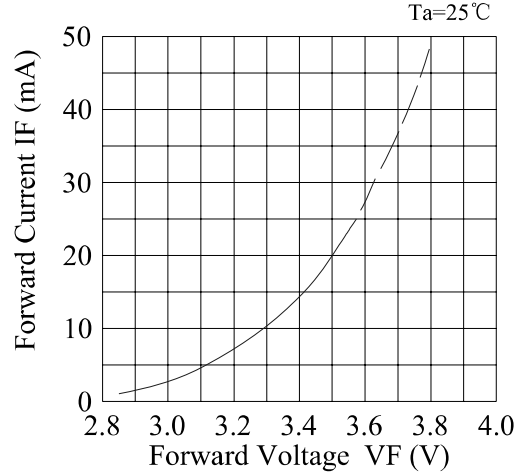
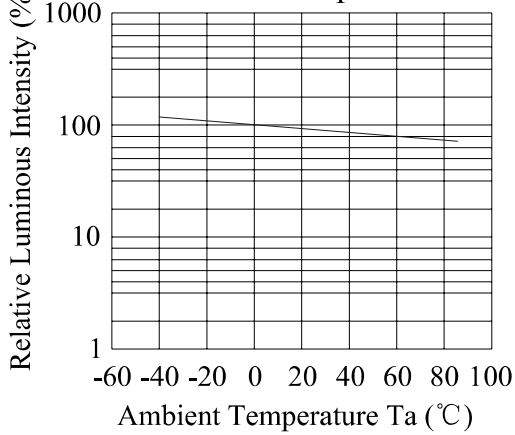
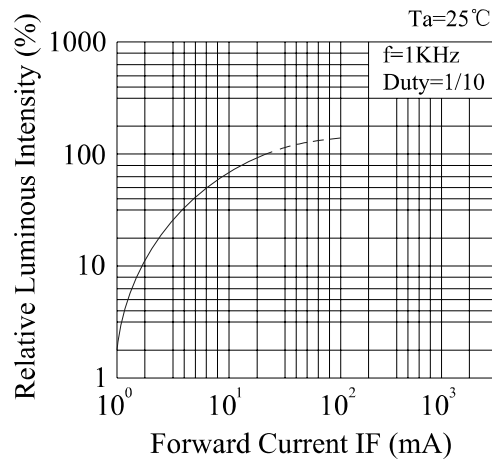
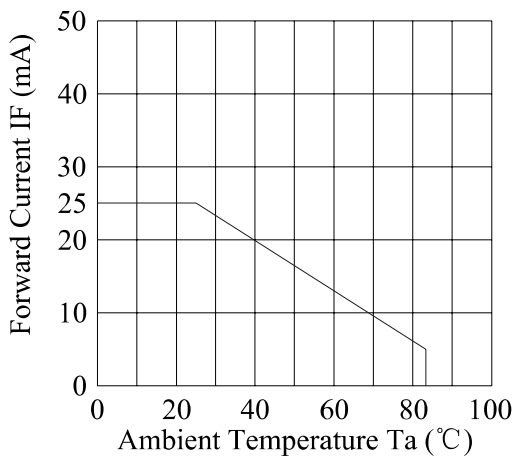
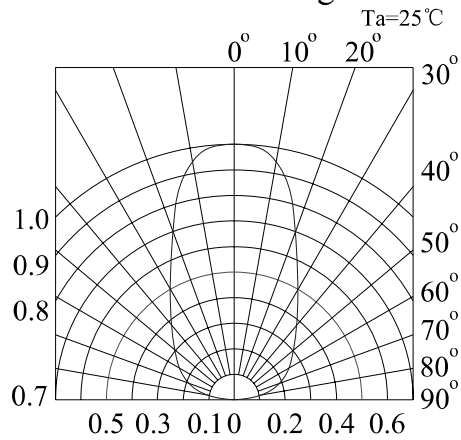
Pure Green:
Spectrum Distribution

Forward Current & Forward Voltage

Luminous Intensity & Ambient Temperature

Luminous Intensity & Forward Current

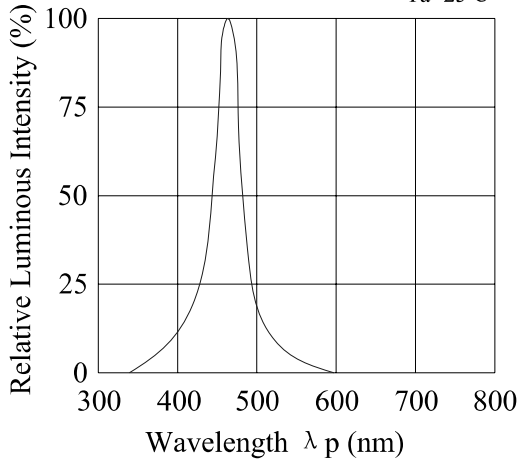
Forward Current Derating Curve

Radiation Diagram

Blue:

Spectrum Distribution

Ta=25°C



Forward Current & Forward Voltage

Ta=25°C

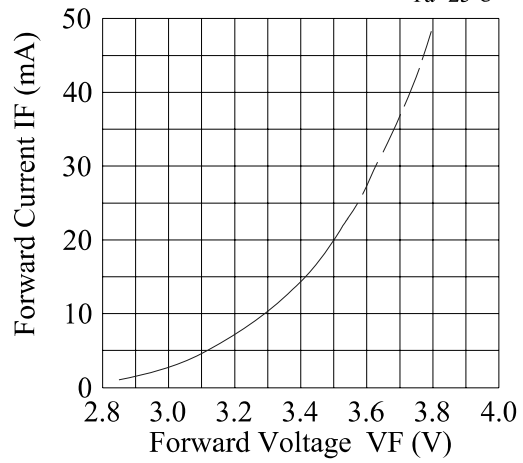

Luminous Intensity & Ambient Temperature

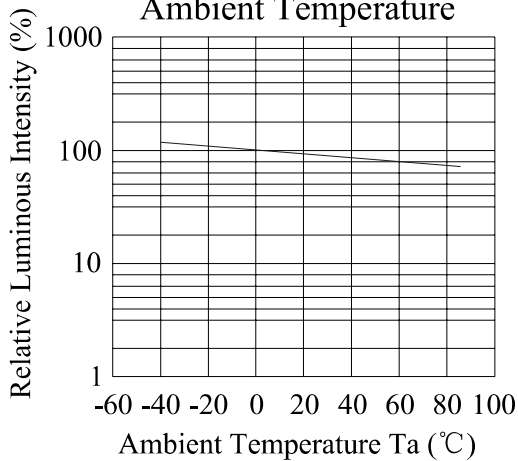

Luminous Intensity & Forward Current

Ta=25°C

f=1KHz
Duty=1/10

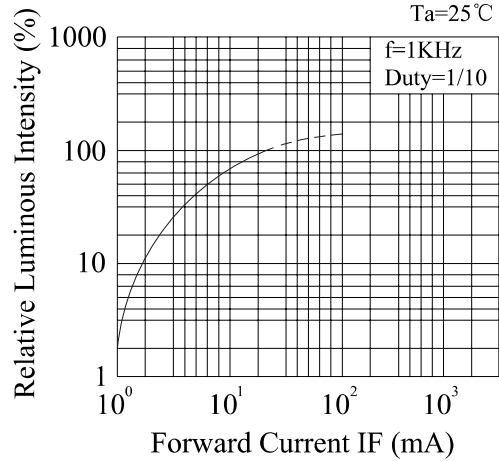

Forward Current Derating Curve

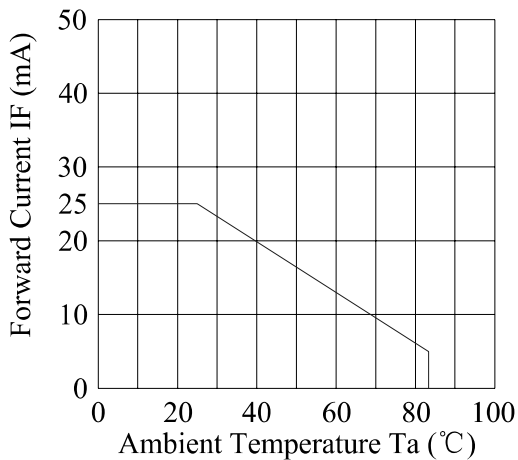

Radiation Diagram

Ta=25°C

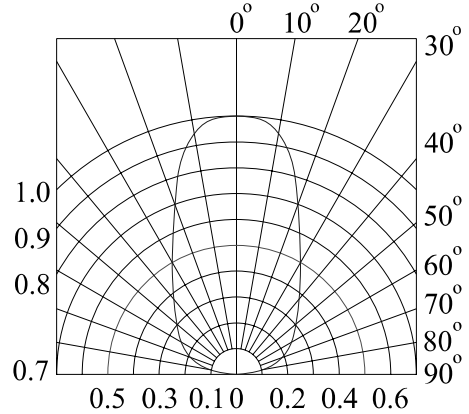

Reliability Test Items And Conditions:

The reliability of products shall be satisfied with items listed below:

Confidence level: 90%.

LTPD: 10%.

1) Test Items and Results:

Test Item	Standard Test Method	Test Conditions	Note	Number of Damaged
Resistance to Soldering Heat	JEITA ED-4701 300 302	Tsld=260±5°C, 10sec 3mm from the base of the epoxy bulb	1 time	0/100
Solder ability	JEITA ED-4701 300 303	Tsld=235±5°C, 5sec (using flux)	1time over 95%	0/100
Thermal Shock	JEITA ED-4701 300 307	0°C~100°C 15sec, 15sec	100 cycles	0/100
Temperature Cycle	JEITA ED-4701 100 105	-40°C~25°C~100°C~25°C 30min,5min,30min,5min	100 cycles	0/100
Moisture Resistance Cycle	JEITA ED-4701 200 203	25°C~65°C~-10°C 90%RH 24hrs/1cycle	10 cycles	0/100
High Temperature Storage	JEITA ED-4701 200 201	Ta=100°C	1000hrs	0/100
Terminal Strength (Pull test)	JEITA ED-4701 400 401	Load 10N (1kgf) 10±1sec	No noticeable damage	0/100
Terminal Strength (bending test)	JEITA ED-4701 400 401	Load 5N (0.5kgf) 0°~90°~0° bend 2 times	No noticeable damage	0/100
Temperature Humidity Storage	JEITA ED-4701 100 103	Ta=60°C, RH=90%	1000hrs	0/100
Low Temperature Storage	JEITA ED-4701 200 202	Ta=-40°C	1000hrs	0/100
Steady State Operating Life		Ta=25°C, IF=30mA	1000hrs	0/100
Steady State Operating Life of High Humidity Heat		Ta=60°C, RH=90%, IF=30mA	500hrs	0/100
Steady State Operating Life of Low Temperature		Ta=-30°C, IF=20mA	1000hrs	0/100

2) Criteria for Judging the Damage:

Item	Symbol	Test Conditions	Criteria for Judgment	
			Min	Max
Forward Voltage	VF	IF=20mA	---	F.V.*)×1.1
Reverse Current	IR	VR=5V	---	F.V.*)×2.0
Luminous Intensity	IV	IF=20mA	F.V.*)×0.7	---

*) F.V.: First Value.

Please read the following notes before using the product:

1. Over-current-proof

Customer must apply resistors for protection, otherwise slight voltage shift will cause big current change (Burn out will happen).

2. Storage

2.1 Do not open moisture proof bag before the products are ready to use.

2.2 Before opening the package, the LEDs should be kept at 30°C or less and 90%RH or less.

2.3 The LEDs should be used within a year.

2.4 After opening the package, the LEDs should be kept at 30°C or less and 70%RH or less.

2.5 The LEDs should be used within 168 hours (7 days) after opening the package.

3. Soldering Condition

3.1 Pb-free solder temperature profile

3.2 Reflow soldering should not be done more than two times.

3.3 When soldering, do not put stress on the LEDs during heating.

3.4 After soldering, do not warp the circuit board.

4. Soldering Iron

Each terminal is to go to the tip of soldering iron temperature less than 260°C for 5 seconds within once in less than the soldering iron capacity 25W. Leave two seconds and more intervals, and do soldering of each terminal. Be careful because the damage of the product is often started at the time of the hand solder.

5. Repairing

Repair should not be done after the LEDs have been soldered. When repairing is unavoidable, a double-head soldering iron should be used. It should be confirmed beforehand whether the characteristics of the LEDs will or will not be damaged by repairing.

6. Caution in ESD

Static Electricity and surge damages the LED. It is recommended to use a wrist band or anti-electrostatic glove when handling the LED. All devices equipment and machinery must be properly grounded.