



**HESTORE.HU**

elektronikai alkatrész áruház

**EN:** This Datasheet is presented by the manufacturer.

Please visit our website for pricing and availability at [www.hestore.hu](http://www.hestore.hu).

### Extrusion

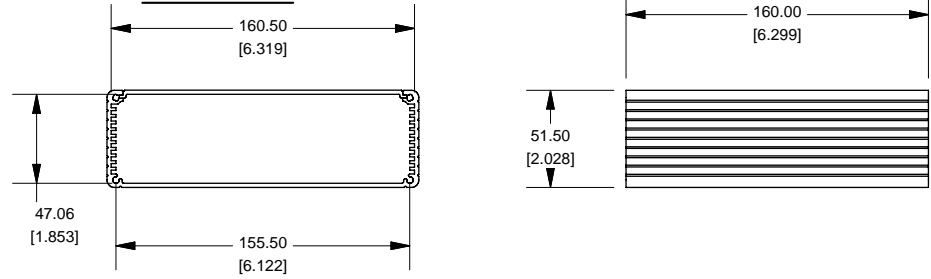

EXTRUSION DESIGNED FOR 160MM WIDE P BOARD

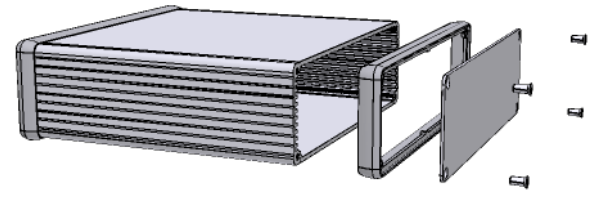

### Slot Details

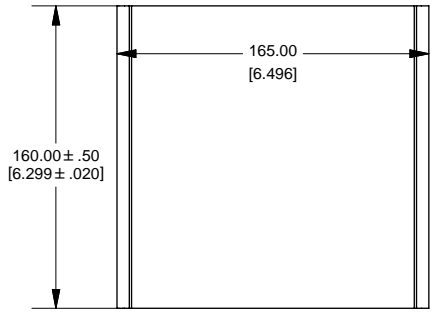
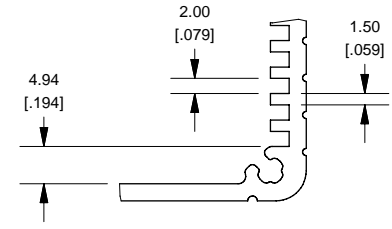

### End Plate

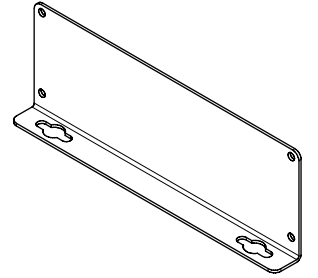
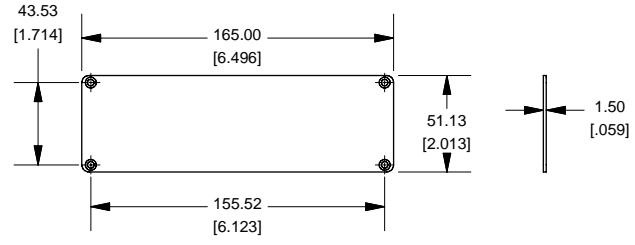

**OPTIONAL FLANGE END PANELS  
1455TF**

### Open Bezel

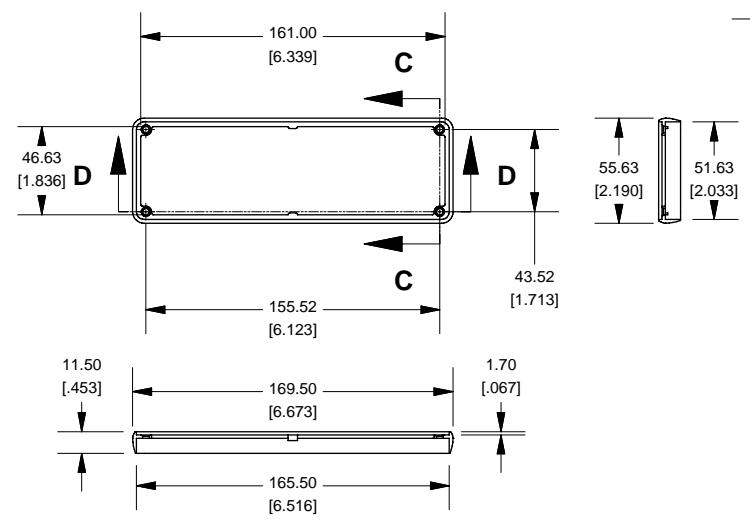

**NOTE**  
 Purchased assembly includes box, plastic bezels, end panels, #6 Taptight screws and self adhesive rubber feet.  
 Box made from Extruded Aluminum 6063.  
 Bezels made with polycarbonate.

1455T1601	
PART NUMBERS	
Clear Anodized	1455T1601
Black Anodized	1455T1601BK
ACCESSORIES	
See website for accessories.	

**HAMMOND  
MANUFACTURING™**

**1455T1601**  
www.hammondmfg.com

Enclosures can be Factory Modified ( Milling, Drilling, Printing etc. )  
 Solid models of this enclosure available in STEP or IGES.  
 Contact Factory [mjm@hammondmfg.com](mailto:mjm@hammondmfg.com)