



**HESTORE.HU**

elektronikai alkatrész áruház

**EN:** This Datasheet is presented by the manufacturer.

Please visit our website for pricing and availability at [www.hestore.hu](http://www.hestore.hu).

## NPN Silicon AF Transistors

## BCX 54 ... BCX 56

### Features

- For AF driver and output stages
- High collector current
- Low collector-emitter saturation voltage
- Complementary types: BCX 51 ... BCX 53 (PNP)

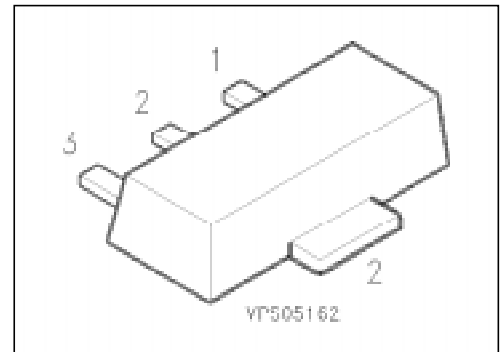

Type	Marking	Ordering Code (tape and reel)	Pin Configuration			Package <sup>1)</sup>
			1	2	3	
BCX 54	BA	Q62702-C954	B	C	E	SOT-89
BCX 54-10	BC	Q62702-C1861				
BCX 54-16	BD	Q62702-C1731				
BCX 55	BE	Q62702-C1729				
BCX 55-10	BG	Q62702-C1730				
BCX 55-16	BM	Q62702-C1903				
BCX 56	BH	Q62702-C1614				
BCX 56-10	BK	Q62702-C1635				
BCX 56-16	BL	Q62702-C1613				

<sup>1)</sup> For detailed information see chapter Package Outlines.

## Maximum Ratings

Parameter	Symbol	Values			Unit
		BCX 54	BCX 55	BCX 56	
Collector-emitter voltage	$V_{CE0}$	45	60	80	V
Collector-base voltage	$V_{CB0}$	45	60	100	
Emitter-base voltage	$V_{EB0}$	5	5	5	
Collector current	$I_C$	1			A
Peak collector current	$I_{CM}$	1.5			
Base current	$I_B$	100			mA
Peak base current	$I_{BM}$	200			
Total power dissipation, $T_s = 130\text{ °C}$	$P_{tot}$	1			W
Junction temperature	$T_j$	150			°C
Storage temperature range	$T_{stg}$	- 65 ... + 150			

## Thermal Resistance

Junction - ambient <sup>1)</sup>	$R_{th JA}$	≤ 75	K/W
Junction - soldering point	$R_{th JS}$	≤ 20	

<sup>1)</sup> Package mounted on epoxy pcb 40 mm × 40 mm × 1.5 mm/6 cm<sup>2</sup> Cu.

## Electrical Characteristics

at  $T_A = 25\text{ °C}$ , unless otherwise specified.

Parameter	Symbol	Values			Unit
		min.	typ.	max.	

### DC characteristics

Collector-emitter breakdown voltage $I_C = 10\text{ mA}$	$V_{(BR)CE0}$				V
BCX 54		45	—	—	
BCX 55		60	—	—	
BCX 56		80	—	—	
Collector-base breakdown voltage $I_C = 100\text{ }\mu\text{A}$	$V_{(BR)CB0}$				
BCX 54		45	—	—	
BCX 55		60	—	—	
BCX 56		100	—	—	
Emitter-base breakdown voltage $I_E = 10\text{ }\mu\text{A}$	$V_{(BR)EB0}$	5	—	—	
Collector cutoff current $V_{CB} = 30\text{ V}$ $V_{CB} = 30\text{ V}, T_A = 150\text{ °C}$	$I_{CB0}$	—	—	100	nA
		—	—	20	$\mu\text{A}$
Emitter cutoff current $V_{EB} = 4\text{ V}$	$I_{EB0}$	—	—	20	nA
DC current gain <sup>1)</sup> $I_C = 5\text{ mA}, V_{CE} = 2\text{ V}$ $I_C = 150\text{ mA}, V_{CE} = 2\text{ V}$ BCX 54, BCX 55, BCX 56 BCX 54-10, BCX 55-10, BCX 56-10 BCX 54-16, BCX 55-16, BCX 56-16 $I_C = 500\text{ mA}, V_{CE} = 2\text{ V}$	$h_{FE}$	25	—	—	—
		40	—	250	
		63	100	160	
		100	160	250	
		25	—	—	
Collector-emitter saturation voltage <sup>1)</sup> $I_C = 500\text{ mA}, I_B = 50\text{ mA}$	$V_{CEsat}$	—	—	0.5	V
Base-emitter voltage <sup>1)</sup> $I_C = 500\text{ mA}, V_{CE} = 2\text{ V}$	$V_{BE}$	—	—	1	

### AC characteristics

Transition frequency $I_C = 50\text{ mA}, V_{CE} = 10\text{ V}, f = 20\text{ MHz}$	$f_T$	—	100	—	MHz
---	-------	---	-----	---	-----

<sup>1)</sup> Pulse test:  $t \leq 300\text{ }\mu\text{s}, D = 2\%$ .

**Total power dissipation  $P_{tot} = f(T_A^*; T_S)$**

\* Package mounted on epoxy

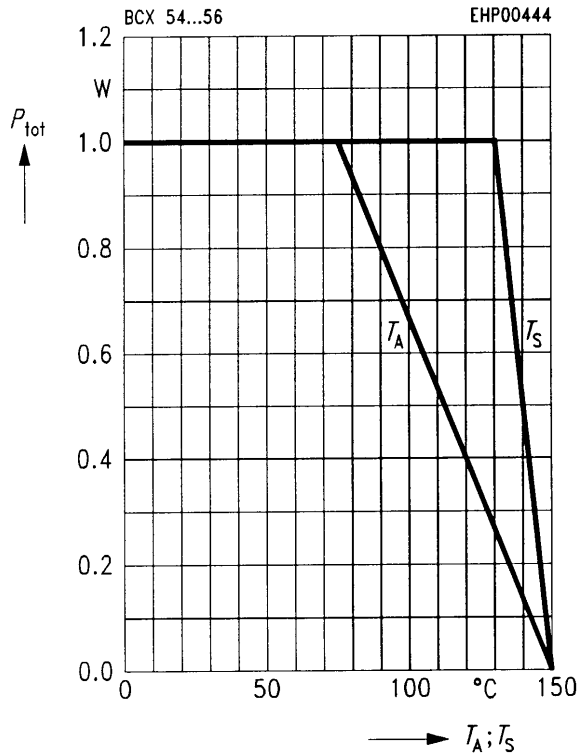

**Transition frequency  $f_T = f(I_C)$**

$V_{CE} = 10\text{ V}$

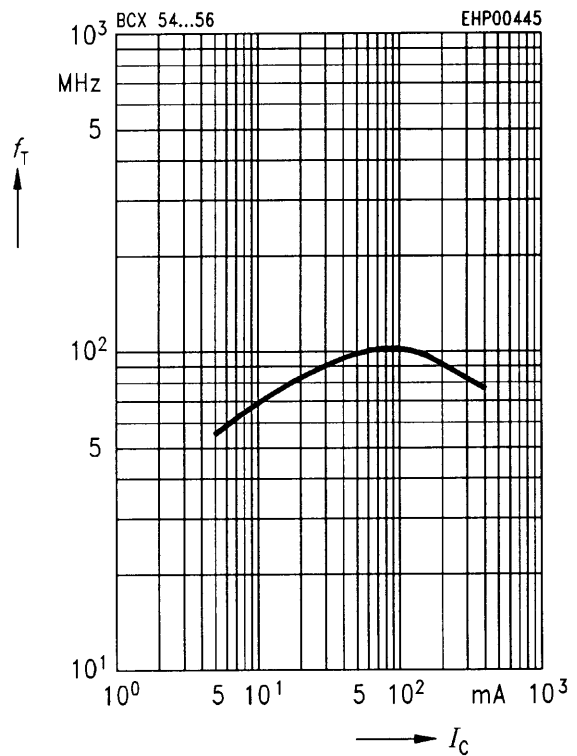

**Permissible pulse load  $P_{tot\ max}/P_{tot\ DC} = f(t_p)$**

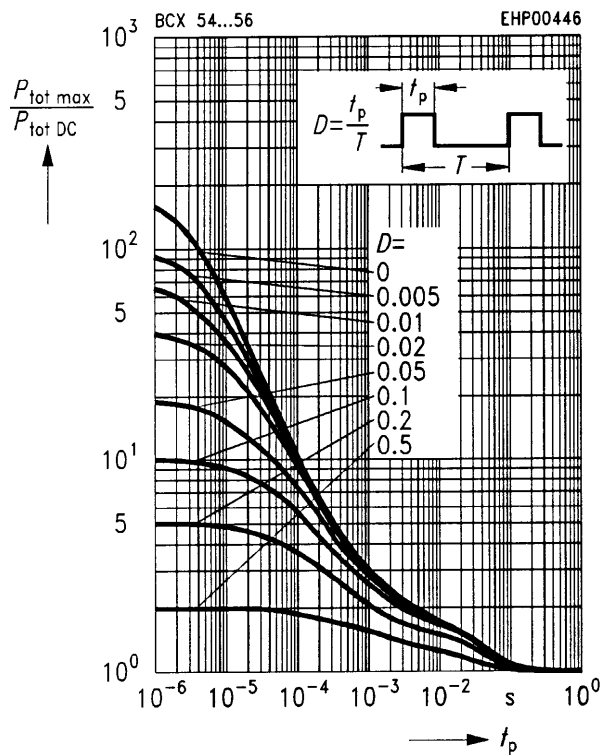

**Collector cutoff current  $I_{CB0} = f(T_A)$**

$V_{CB} = 30\text{ V}$

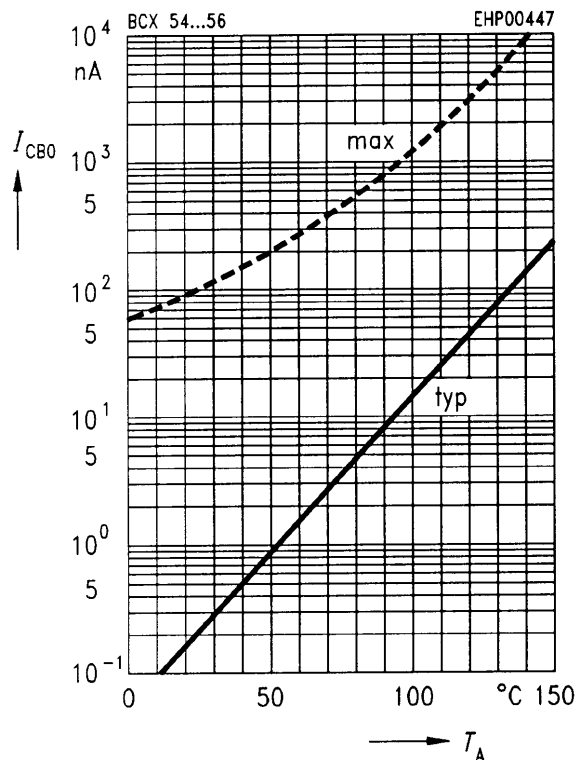

**Collector current  $I_C = f(V_{BE})$**

$V_{CE} = 2\text{ V}$

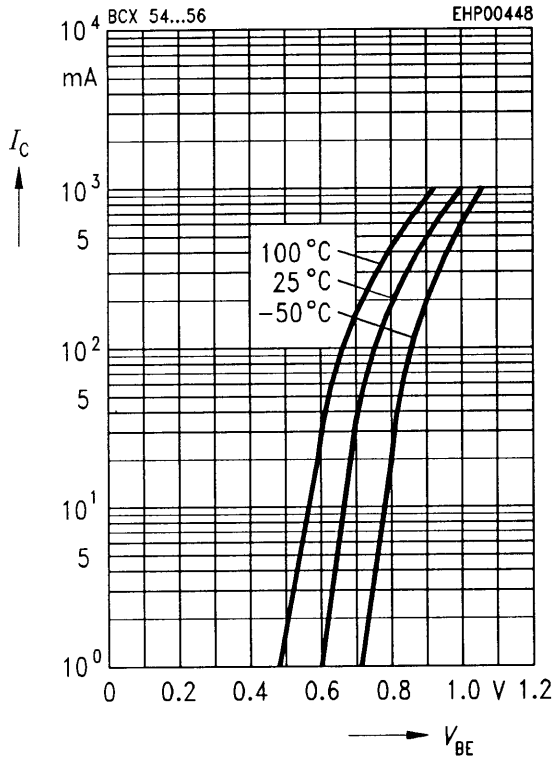

**Collector-emitter saturation voltage  $I_C = f(V_{CEsat})$**

$I_C = f(V_{CEsat})$

$h_{FE} = 10$

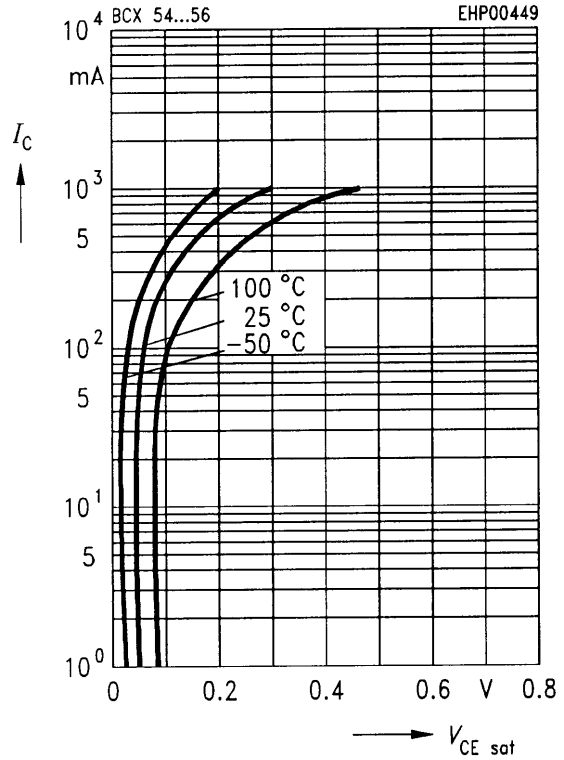

**Base-emitter saturation voltage  $I_C = f(V_{BEsat})$**

$I_C = f(V_{BEsat})$

$h_{FE} = 10$

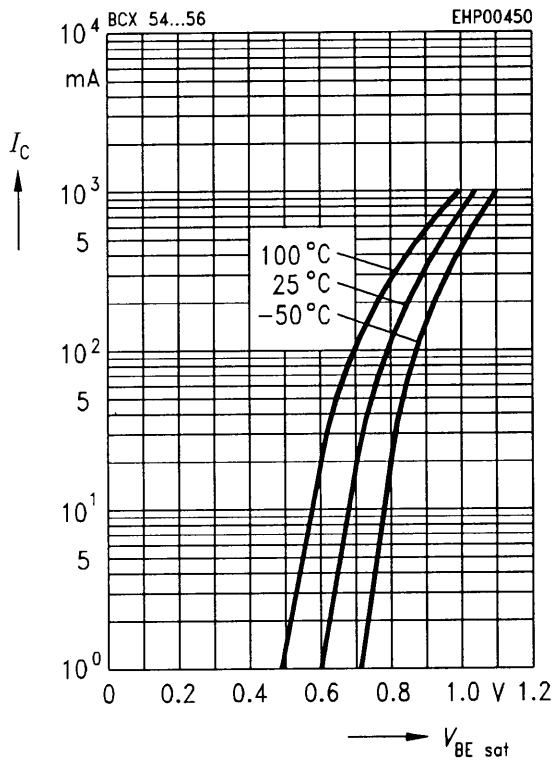

**DC current gain  $h_{FE} = f(I_C)$**

$V_{CE} = 2\text{ V}$

